



Hydraulics Catalog

Hydraulic Hose, Fittings & Equipment



Continental

WORLDWIDE. WORLD-CLASS. WORLD-CHANGING.





Continental is a world leader in industrial rubber and plastic products and has the largest global footprint of any rubber products manufacturer.

Our knowledge and expertise allow us to deliver the most innovative and highest-quality products on the market. Plus, our extensive problem-solving experience across multiple industries and applications enables us to share innovations over our entire product offering. Which means we can deliver unexpected solutions and advanced improvements in situations where others can't.

We push the boundaries of what's possible, and we're constantly solving tomorrow's most challenging problems—today and every day.

It's Why We're Your Global Partner of Choice for Industrial Fluid Solutions.

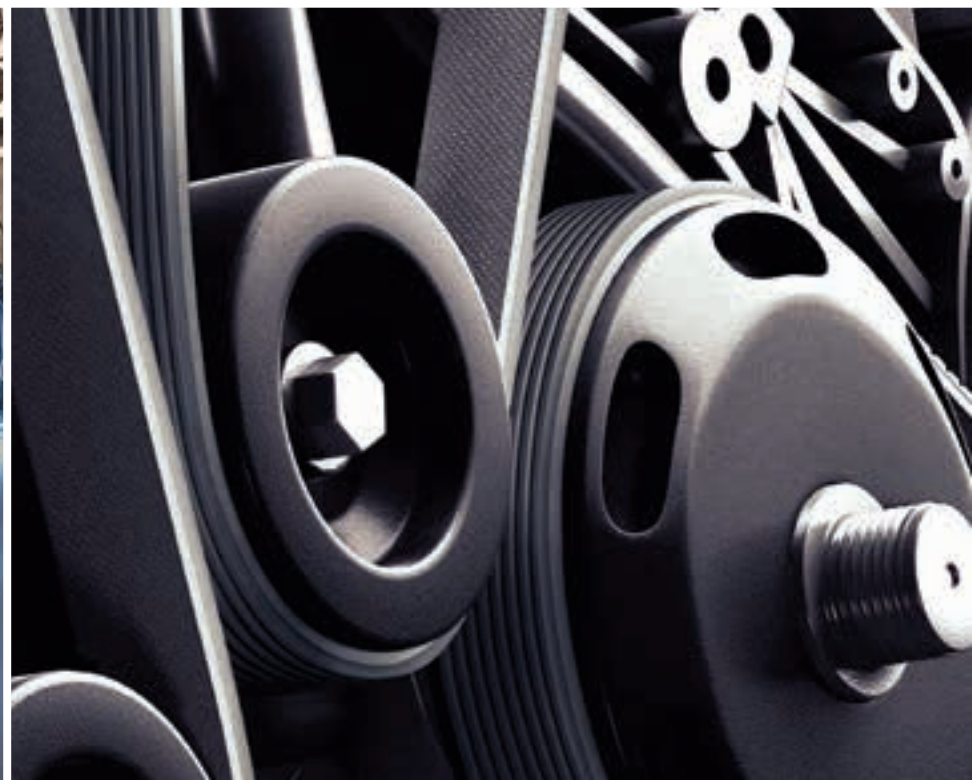



Key Products

EXCEEDING HYDRAULIC HOSE STANDARDS

Continental hydraulic hose and fittings exceed your demands in the harshest environments. From construction, oil and gas, mining and manufacturing to transportation, our designers and engineers constantly bring new innovations to the field.

HOSE

Extended Life™ XR16SC High-Pressure Hose

When the job requires tight bends, flexibility and abrasion resistance, this high-pressure hydraulic hose steps up to the task. Using a nitrile inner tube, two high-tensile steel wire braids of reinforcement and the Extended Life™ extra abrasion-resistant cover, it can handle a system working pressure up to 5,800 psi (31 MPa).

- **NEW large bore sizes now available (-20, -24 & -32)**
- **All XR16SC sizes use B2 series fittings**

KEY FEATURES

 Extended Life™ Cover

 Meets Flame Resistance USMSHA Designation



Outer cover with Extended Life™ extra abrasion-, oil- and weather-resistant synthetic rubber.

Two-wire braided construction of high-tensile steel wire.

Oil-resistant NBR (Nitrile) inner tube.



STAY CONNECTED UNDER THE HIGHEST PRESSURES

Continental fittings are constructed from a single piece of steel without brazed or welded joints to provide ultimate protection against leaks and potential leak paths. With full-length crimps and a low-profile design that will last longer, the interlocking Bite-to-Wire technology delivers maximum coupling retention for safer assembly and reliability under the toughest pressure – no internal or external skive required.

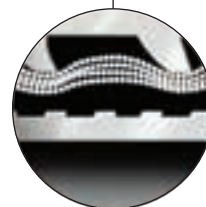

B2

Full-Length Crimp offers maximum coupling retention for a safe and longer-lasting assembly.

Our Bite-to-Wire fittings penetrate the cover with a powerful bite into the wire reinforcement, resulting in even hose compression and maximum integrity.



Key Products

HOSE

Constant Pressure Spiral Hose

Our Continental Constant Pressure Spiral Hydraulic Hose provides you with the superior quality and reliability you need in the toughest conditions. Our Extended Life™ high abrasion-resistant cover helps minimize downtime; the half-bend radius allows routing in tight spaces which can reduce hose length requirements. The constant pressure performance across all sizes aids in selecting the right hose for the application; while our simplified fittings and color-coded system are faster, safer and more cost effective. When the pressure is on, you want Continental there.

KEY FEATURES

-  Made for constant pressure
-  1/2 Bend

STAY FLEXIBLE IN EVEN THE TIGHTEST SITUATIONS

Flexibility plays a major role in your hydraulic hose operation and efficiency. With a bend radius up to 1/2 that of SAE conventional spiral hose standards, our hose is extremely flexible, easier to route and reduces the chance of bending too tightly. This helps provide increased hose savings and a reduction of shaped hose ends while equipping you with a safer, more cost-effective way to keep you moving throughout the day.

Bend Radius Comparison vs. SAE Standard

Not only does our hose provide a reduced bend radius, but the less-bulky inner tube and outer wall construction requires less force to bend for a more manageable routing process. This results in reduced installer fatigue and faster installation times overall.



Continental Constant Pressure Hose is up to 1/2 SAE bend radius specification.





STAY UP, OPERATIONAL AND SAFER ALL DAY.

Our color-coding system is designed specifically for our hose and provides a safe and user-friendly replacement process. Quickly recognize which colors align to the different hose pressures to avoid injury and ensure you install the correct hose with confidence.



Constant Pressure Spiral Hose are designed to be easily identifiable by pressure rating for safe replacement.



Key Products

HOSE

Arctic Hose

High-pressure hydraulic hose used in construction, forestry, surface mining, oil and gas, waste handling, utilities and other applications where lower temperature can impact performance.



KEY FEATURES

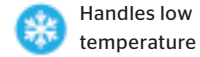

Handles low temperature

B2 - Bite-to-Wire fittings across the entire line (1/4" to 2")

EQUIPMENT

PC440i Production Crimper

The PC440i Production Crimper Controller can store up to 50 dies and 150 crimp settings, and its special pressure transducer monitors crimping effort, eliminating trial-and-error crimping.

Automatically convert inches to millimeters and vice-versa so that no calculation is ever required.



KEY FEATURES

7.5 HP Power Source

High speed pump

Capable of crimping up to 2" 6-spiral Hydraulic and 4" Industrial Hose



NEW LOW TEMP HOSE RATED TO -70°F

SERVICE

Ready 2 Go

We know your time is valuable. That is why we want to help you get back to doing what you do best, faster. The **Ready 2 Go (R2G)** system has pre-coupled Continental hose assemblies ready for delivery, so you can do less waiting.

And since the R2G System is available in 37 different hose families, you can rely on us to have the hose you need, when you need it. It is convenience on a whole new level.



Look for the icon – indicated standard sizes are available and Ready 2 Go.

TIME IS MONEY. AND WE ARE SAVING YOU BOTH.

Heavy Duty + Hot Water



Frontier™ Multipurpose



Neptune™ Pressure Washer



F5™ Air Hose



Connected Crimper Line

PROVIDING SMART SOLUTIONS BEYOND RUBBER

Continental has invested millions of dollars into our hose, fitting and hose equipment plants. These state-of-the-art facilities produce products that are second to none and will help us meet your needs for today and tomorrow.





New fully integrated CrimplIQ™ Controller

CrimplIQ™ Controller

Continental's CrimplIQ™ Controller is powered by Continental Fluid Solutions technology, which provides direct access to all crimping features and information. It supports a user-friendly interface to guide new and advanced users through the crimping process quickly and easily.

- WiFi-enabled for support, updates, reporting and cloud connectivity

KEY FEATURES

- › 10" high-resolution touch screen monitor
- › Automatic crimp spec updates
- › "Simple crimp" step approach
- › Individual user preference settings
- › Integrated calipers, either Bluetooth or USB, to automatically send crimp measurements
- › Cloud backup
- › Dynamic machine maintenance tracking

CONTROL PANEL ICONS



Easy step-by-step crimp operation, supported with always up-to-date crimp specs



Get support within the application (automatically uploads machine status with support request)



Ability to easily favorite up to thousands of crimp specifications, complete with notes for easy reference and accurate crimping



Dynamic machine maintenance tracking, ensuring that crimper maintenance occurs at the proper time



Integrated training and manuals, allowing for easy education

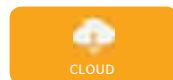

Connection to the cloud, allowing for production-run information and comprehensive backup

Note: Internet connection required to take full advantage of crimper features

Mobile Services

GET THE MOST UP-TO-DATE SPECIFICATIONS

The **MyCrimp™** application provides users with up-to-date specifications to properly crimp Continental hydraulic hose and fittings. Users can search by hose style, coupling style, hose size and crimper. The application contains all the information required to properly set up and crimp the desired hose and fitting.



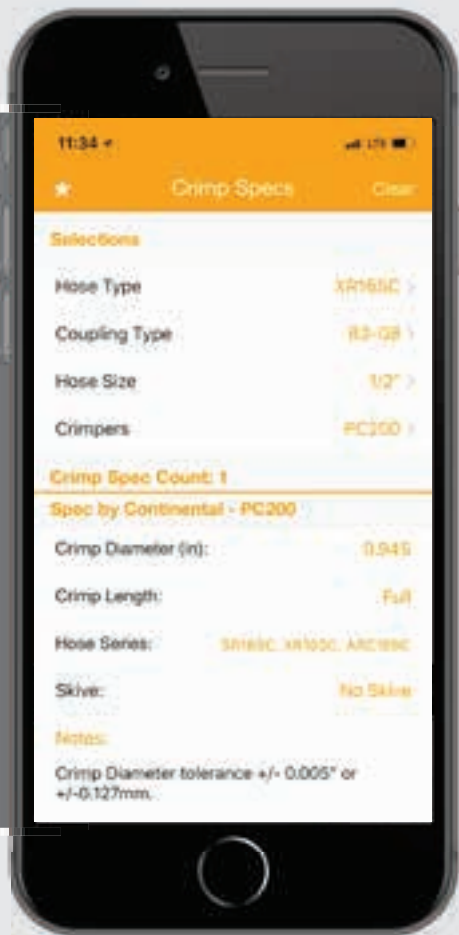

The new app features the same data you're accustomed to seeing, but now at your fingertips. And never wonder again if it is the most up-to-date version.

Search the app store for: **MyCrimp/Contitech**
 Download today for free!



> **APPLE APP**



> **ANDROID APP**

INNOVATIVE DISTRIBUTOR SOLUTIONS

At Continental, we're relentless in our drive to move business forward in revolutionary ways. That's why we developed Conti Fluid Solutions, part of a global vision to find and create connections allowing us to develop unmatched, often custom solutions.



IND
 INDUSTRIAL HOSE
 VIRTUAL CATALOG



HOSE SELECT



C+
 COMPETITIVE
 ADVANTAGE



HYD
 HYDRAULICS
 VIRTUAL CATALOG



BIN LABEL



HOSE TRAKKER

We take innovation beyond the limits of today's technology and bring tomorrow closer. Access cutting-edge intel and insight, and go beyond anything you've ever imagined. Register today for Continental Distributor access at www.contifluidsolutions.com.

Hydraulic Hose Line

Varied pressures, abrasion levels and temperatures are no match for Continental Hydraulic Hose.



HOSE

Continental

LOOK FOR HIGHLIGHTED ATTRIBUTES



Desert® DR1SN
SAE 100R1AT
EN 856 1SN
› 1-braid hose
› Meets higher EN/DIN pressures

302°

ID 1/4" - 2"



Desert® DR2SN
SAE 100R2AT
EN 853 2SN
› 2-braid hose
› Meets higher EN/DIN pressures

302°

ID 1/4" - 2"



Desert® DR16SC
SAE 100R16
› 2-braid hose
› Excellent impulse performance

302° 

ID 1/4" - 1"



Desert® DR5
SAE 100R5
SAE J1942
› Reinforced with 1 braid of textile and 1 braid of steel

302°

ID 3/16" - 1 13/16"



Desert® DUT
SAE J1402 Type A1
› Medium-pressure hose for fleet applications

302°

ID 3/16" - 1 1/2"



HR6
SAE 100R6
EN 854 R6
› Handles high temperatures
› Made for textile reinforced applications

275°

ID 1/4" - 3/4"



Arctic® LR2SN
SAE 100R2AT
EN 856 2SN
› Made for hydraulic oil lines
› Handles low temperatures

-70°

ID 1/4" - 2"



Arctic® LR16SC
SAE 100R16
EN 857 2SC
› 1-braid hose
› Meets higher EN/DIN pressures
› Handles low temperatures

-70°

ID 1/4" - 1"



SR1SN
SAE 100R1AT
EN 853 1SN
› 1-braid hose
› Meets higher EN/DIN pressures

ID 3/16" - 2"



SR2SN
SAE 100R2AT
EN 856 2SN
› 2-braid hose
› Meets higher EN/DIN pressures

ID 3/16" - 2"



SR16SC
SAE 100R16
EN 857 2SC
› High-pressure applications with tight bends



ID 1/4" - 1 1/4"



SCP3
SAE 100R17
› 1- or 2-braid hose
› High-pressure applications with tight bends



ID 1/4" - 1"



SR3
SAE 100R3
EN 854 R3
› Reinforced with 2 textile braids

ID 1/4" - 1"



SR5
SAE 100R5
› For general purpose medium-pressure applications

ID 3/16" - 1 1/2"



SR6
SAE 100R6
EN 854 R6
› Made for textile-reinforced applications

ID 3/16" - 3/4"



SR12
SAE 100R12
EN 856 R12
› Very high-pressure applications subject to surges or flexing

ID 3/8" - 2"

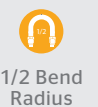
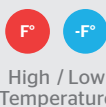

Hydraulic Hose Line



SR13
SAE 100R13
EN 856 R13
› 4- or 6-spiral hose
› Very high-pressure applications subject to surges or flexing

ID 3/4" - 2"



SR15
SAE 100R15
› 4- or 6-spiral hose
› Severe high-pressure applications

ID 1/2" - 2"



S4SH
EN 856 4SH
DIN 20023 4SH
› Very high-pressure pulsating applications

ID 3/4" - 2"



S4SP
EN 856 4SP
DIN 20023 4SP
› Very high-pressure applications

ID 3/8" - 1"



SGUN
Grease Gun Hose
› Made for general purpose lubrication



ID 3/16"



SHJ
Jack Hose
› Made for high-pressure hydraulic jacking systems



ID 1/4" - 3/8"



Saflex® (NSFX)
› Medium-pressure applications where shock hazards exist
› Non-conductive



ID 1/4" - 1/2"



SR14A
SAE 100R14A
› PTFE line hose for air compressor discharge
› Chemical-resistant



ID 3/16" - 1"



SFS
Fire Suppression
› Medium-pressure applications
› Made for mining, forestry and firefighting equipment



ID 1/4" - 1"



Prospector™ BOP 3000
Blowout Prevention
› Made for hydraulic connections in oil and gas exploration

ID 3/8" - 1"



Prospector™ BOP 5000
Blowout Prevention
› Made for hydraulic connections in oil and gas exploration

ID 3/8" - 2"



Prospector™ Hot Oiler
Static Pressure
› Made to initiate the flow of hot oil and bring it to the surface



ID 1 1/2"



MIL-DTL-13444H
Type I
Military
› Made for hydraulic oil and fuel lines

ID 3/16" - 3/4"



MIL-DTL-13444H
Type III
Military
› Made for medium-pressure hydraulic oil and fuel lines

ID 3/16" - 1 1/2"



MIL-DTL-13531
Type II, Class A
Military
› Made for medium- and high-pressure hydraulic systems

ID 3/16" - 1"



MIL-DTL-3992
Type I, Class I
Military
› Made for low-pressure flexible connections in air brake systems

ID 3/8" - 1/2"

HOSE

Continental

LOOK FOR HIGHLIGHTED ATTRIBUTES



MIL-DTL-8788
Military
 › High-pressure applications requiring interoperability

ID 7/32" - 7/8"



Insta-Grip™ 300
Push-On
 › 300 psi maximum working pressure
 › Non-conductive

 ID 1/4" - 1"



Insta-Grip™ TC
Push-On
 › Low-pressure applications

ID 1/4" - 3/4"



Insta-Grip™ HT 300
Push-On
 › 300 psi maximum working pressure

 ID 1/4" - 3/4"



FXG
Push-On
 › 400 psi maximum working pressure
 › Non-conductive

 ID 3/16" - 1"



Galaxy®
4890, 4826, 4867
Air Conditioning
 › For applications requiring Cool Clip® or Cool Crimp™ fittings

ID 5/16" - 3/4"



SR7
SAE 100R7
EN 855 R7
 › Medium-pressure thermoplastic hose with a perforated cover

 ID 1/8" - 1"



SR8
SAE 100R8
EN 855 R8
 › Thermoplastic hose with a perforated cover

ID 3/16" - 1/2"



NR7
SAE 100R7
 › Medium-pressure thermoplastic hose

 ID 1/8" - 1"



NR8
SAE 100R8
 › High-pressure thermoplastic hose

 ID 1/4" - 1/2"



TR7
SAE 100R7
 › Twin-line
 › Medium-pressure thermoplastic hose with a perforated cover

ID 3/16" - 1/2"



TR8
SAE 100R8
 › Twin-line
 › Thermoplastic hose with a perforated cover

ID 3/8" - 1/2"



BR7
SAE 100R7
 › Twin-line
 › Medium-pressure thermoplastic hose

 ID 1/4" - 1/2"



SR18
SAE 100R18
 › Thermoplastic hose
 › Extremely flexible in cold temperatures

 ID 1/4" - 1/2"



HR4
SAE 100R4
 › Return or suction line hose
 › Handles high temperature

 ID 3/4" - 4"

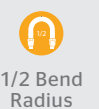
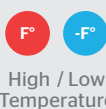

Fittings and Adapters

ONE SOURCE, MANY SELECTIONS.

We are your one source for a wide selection of high-performance hydraulic hose fittings, covering a wide range of designs, configurations, sizes and pressure ratings.

INDUSTRY-LEADING FITTINGS

Crimped, Field-Grip (Re-attachable), Push-On and Air Conditioning

THREADS THAT MEET EVERY APPLICATION NEED

SAE, NPTF, JIC, British Standard, DIN, JIS and API

HIGH-PERFORMANCE END STYLES

Straights, Swivels, Elbows and Flanges



BENEFITS & FEATURES

Full-Length Crimp

Maximum coupling retention for a safe and longer-lasting assembly; easier to crimp with a lower profile.

Adapters

Complete line of adapters to change existing end styles to meet your application needs.



No Skive

Assemblies made faster, with fewer steps and less mess.

Zinc Plating

- › Offers corrosion resistance for extended hose assembly and fitting life, easily surpassing the corrosion resistance of **SAE J516** and **ASTM B117**.
- › Silver Chromium-6 Free plating on Ultra-Crimp™, Uni-Crimp and Dual-Grip fittings.



FITTINGS

Continental

FITTING STYLES

High Pressure Bite-to-Wire Fittings

Continental's crimp fittings provide maximum coupling retention on 1- and 2-braid hose as well as 4- and 6-spiral hose. Serrations penetrate the cover with a powerful bite into the wire reinforcement, resulting in even hose compression.



Field-Grip™ Fittings

Non-skive, reattachable for easy installation on DR5 and SR5 (SAE 100R5) hose.



Push-On Fittings

Fittings compatible with Continental push-on hose, including Insta-Grip™ 300, Insta-Grip™ TC, Insta-Grip™ HT 300 and FLEXAGrip™ 300.



Air Conditioning Fittings

Cool Clip® and Cool Crimp™ fittings for all your automotive A/C hose requirements.



QUICK DISCONNECT COUPLINGS



Continental is partnering with a leading innovator in the hose coupling industry - Dixon Quick Coupling, a division of Dixon Valve. This partnership helps us provide you with a broad line of high-quality quick disconnect couplings.

Together, Continental and Dixon will coordinate resources to give you access to industry-leading market knowledge, engineering excellence from state-of-the-art American facilities and superior service.

Table of Contents

HYDRAULIC HOSE

Hydraulic Hose & Fitting Products	26
Layline Updates.....	27
Part Number Designations.....	28-29
Hydraulic Hose Nomenclature.....	30

EXTENDED LIFE™ X SERIES

Extended Life™ XR16SC.....	32
----------------------------	----

CONSTANT PRESSURE CP SERIES

XCP3 - Extended Life™ XCP3.....	34
ACP3 - Armorcoat™ ACP3.....	35
XCP4 - Extended Life™ XCP4.....	36
ACP4 - Armorcoat™ ACP4.....	37
XCP3S.....	38
XCP4S.....	39
XCP5S.....	40
XCP6S.....	41

ARMORCOAT™ A SERIES

ARC16SC - Armorcoat™ ARC16SC.....	43
ARC12 - Armorcoat™ ARC12.....	44
ARC13 - Armorcoat™ ARC13.....	45
ARC15 - Armorcoat™ ARC15.....	46

HIGH TEMPERATURE DESERT® SERIES

DR1SN - Desert® DR1SN.....	48
DR2SN - Desert® DR2SN.....	49
DR16S - Desert® DR16SC.....	50
DR5 - Desert® DR5.....	51
DUT - Desert® DUT.....	52
HR6.....	53

LOW TEMPERATURE ARCTIC® SERIES

LR2SN - Arctic® LR2SN.....	55
LR16SC - Arctic® LR16SC.....	56

LEGACY HOSE

SR1SN.....	58
SR2SN.....	59
SR16SC.....	60
SCP3.....	61
SR3.....	62
SR5.....	63
SR6.....	64
SR12.....	65
SR13.....	66
SR15.....	67
S4SH.....	68
S4SP.....	69

SPECIAL APPLICATION HOSE

SGUN - Grease Gun Hose.....	71
SHJ - Jack Hose.....	72
NSFX - Saflex® NSFX.....	73
SR14A.....	74
SFS - Fire Suppression SFS.....	75
BOP 3000 - Prospector™ BOP 3000.....	76
BOP 5000 - Prospector™ BOP 5000.....	77
Hot Oiler - Prospector™ Hot Oiler.....	78

MILITARY HOSE

MIL-DTL-13444H-I.....	80
MIL-DTL-13444H-III.....	81
MIL-DTL-13531.....	82
MIL-DTL-3992.....	83
MIL-DTL-8788.....	84

PUSH-ON HOSE

IG 300 - Insta-Grip™ 300.....	86
IGTC - Insta-Grip™ TC.....	87
IGHT - Insta-Grip™ HT 300.....	88
FXG - FLEXAGrip™.....	89

AIR CONDITIONING HOSE

G4826 - Galaxy® G4826.....	91
G4867 - Galaxy® G4867.....	92
G4890 - Galaxy® SLE G4890.....	93

THERMOPLASTIC HOSE

SR7.....	95
SR8.....	96
NR7.....	97
NR8.....	98
TR7.....	99
TR8.....	100
BR7.....	101
SR18.....	102

SUCTION & RETURN HOSE

HR4.....	104
----------	-----

HOSE REFERENCE GUIDES & ACCESSORIES

Ready 2 Go Assemblies.....	105-111
Working Pressure Selection Guide.....	112-117
Special Attributes.....	118-120
Temperature Limits.....	121
Hose Accessories.....	122-123

Table of Contents

HYDRAULIC FITTINGS

Fitting Families.....	126
Fitting Selection.....	127
Hydraulic Fitting Nomenclature.....	128-129
Hydraulic Ferrule Nomenclature.....	129

SECTION 1 – B2 FITTINGS

Fittings for SR1SN, DR1SN, SFS, SR2SN, DR2SN, LR2SN, LR16SC, SR16SC, ARC16SC, DR16SC, XR16SC, SCP3, ACP3, XCP3, XCP4, ACP4, SR12, ARC12

How to Use the Fittings Table.....	131
B2 Fittings Overview.....	132-134
JIC 37° Flare (SAE J514).....	135-139
SAE 45° J512 Flare.....	140-142
SAE 45° Inverted Flare.....	142-143
NPTF.....	144-147
NPSM.....	147
GTF.....	148
SAE J514 Flareless Tube.....	148
Standpipe.....	149
O-Ring Face Seal (SAE J1453 ORS/ORFS).....	150-153
O-Ring Boss Straight Thread (SAE J514).....	154-155
Code 61 Flange (SAE J518).....	156-159
Code 62 Flange (SAE J518).....	160-162
Caterpillar® Flange.....	163-164
Hammer Union.....	165
Komatsu® Flange.....	165-166
BSPP (British Standard Pipe Parallel).....	166-168
BSPT (British Standard Pipe Tapered).....	168
BSP Flat Seat (British Standard Pipe).....	169
DIN 24° Light.....	169-171
DIN 24° Heavy.....	172-175
DIN 60°.....	175-176
Komatsu® 30° Flare with Metric Threads.....	176-177
JIS 30° (Parallel Pipe Threads).....	178
Hose Joiner.....	178

SECTION 2 – SG FITTINGS

Fittings for SR12, ARC12, SR13, ARC13, SR15, ARC15, S4SP, S4SH, XCP3S, XCP4S, XCP5S, XCP6S

How to Use the Fittings Table.....	179
SG Fittings Overview.....	180
JIC 37° Flare (SAE J514).....	183-186
NPTF.....	187-188
NPT API.....	188
NPSM.....	188
Standpipe.....	189
O-Ring Face Seal (SAE J1453 ORS/ORFS).....	189-192
O-Ring Boss Straight Thread (SAE J514).....	192

Code 61 Flange (SAE J518).....	193-198
Code 62 Flange (SAE J518).....	198-201
Caterpillar® Flange.....	202-205
Hammer Union.....	205
Komatsu® Flange.....	206
BSPP (British Standard Pipe Parallel).....	207-208
BSPT (British Standard Pipe Tapered).....	209
BSP Flat Seat (British Standard Pipe).....	209
DIN 24° Light.....	209-211
DIN 24° Heavy.....	211-213
Komatsu® 30° Flare with Metric Threads.....	214-215
JIS 30° (Parallel Pipe Threads).....	215

SECTION 3 – S6 AND DG FITTINGS

Fittings for SR13, ARC13, SR15, ARC15, S4SH, S4SP

How to Use the Fittings Table.....	216
S6 and DG Fittings Overview.....	217
JIC 37° Flare (SAE J514).....	219-220
NPTF.....	221
NPM API.....	221
O-Ring Face Seal (SAE J1453 ORS/ORFS).....	222-223
Code 61 Flange (SAE J518).....	224-227
Code 62 Flange (SAE J518).....	227-230
Caterpillar® Flange.....	230-232
Hammer Union.....	233
BSPP (British Standard Pipe Parallel).....	233-235
BSPT (British Standard Pipe Tapered).....	235

SECTION 4 – BT FITTINGS

Fittings for HR4

How to Use the Fittings Table.....	236
BT Fittings Overview.....	237
JIC 37° Flare (SAE J514).....	238-239
NPTF.....	240
O-Ring Face Seal (SAE J1453 ORS/ORFS).....	240
Code 61 Flange (SAE J518).....	241

SECTION 5 – UC FITTINGS

Fittings for SR1SN, SR2SN, SR3, SR5, DR5, SR6, HR4, HR6, SR14A, SFS, SCP3, ACP3, BOP

How to Use the Fittings Table.....	242
UC Fittings Overview.....	243
JIC 37° Flare (SAE J514).....	245-249
SAE 45° Flare (J512).....	250-251
SAE 45° Inverted Flare.....	252-253
NPTF.....	253-256
NPSM.....	256

Section 5 UC Fittings, Continued

Flareless Tube Fitting (SAE J514).....	257
Standpipe.....	257-258
O-Ring Face Seal (SAE J1453 ORS/ORFS).....	258-261
O-Ring Boss Straight Thread (SAE J514).....	262-263
Code 61 Flange (SAE J518).....	263-266
Code 62 Flange (SAE J518).....	267-268
BSP (British Standard Pipe Parallel).....	268-270
BSP (British Standard Pipe Tapered).....	270
BSP Flat Seat (British Standard Pipe).....	271
DIN 24° Light.....	271-273
DIN 24° Heavy.....	273-275
DIN 60°.....	275-276
Komatsu® 30° Flare with Metric Threads.....	276-277
JIS 30° (Parallel Pipe Threads).....	278
Hose Joiner.....	278

SECTION 6 – FG FITTINGS

Fittings for SR5, DR5

How to Use the Fittings Table.....	279
FG Fittings Overview.....	280
JIC 37° Flare (SAE J514).....	281-282
SAE 45° J512 Flare.....	283
SAE 45° Inverted Flare.....	284
NPTF.....	284
O-Ring Boss Straight Thread (SAE J514).....	285

SECTION 7 – TP FITTINGS

Fittings for SR7, TR7, NR7, BR7, SR8, TR8, NR8, SR18

How to Use the Fittings Table.....	286
TP Fittings Overview.....	287
JIC 37° Flare (SAE J514).....	288-291
SAE 45° J512 Flare.....	292
SAE 45° Inverted Flare.....	293
NPTF.....	294-296
NPSM.....	296
SAE J514 Flareless Tube.....	297
Standpipe.....	297
O-Ring Face Seal (SAE J1453 ORS/ORFS).....	298-299
O-Ring Boss Straight Thread (SAE J514).....	300-301
BSP (British Standard Pipe Parallel).....	301-302
DIN 60°.....	302
JIS 30° (Parallel Pipe Threads).....	302

SECTION 8 – AC FITTINGS

Fittings, Adapters and Accessories for G4826, G4867, G4890

How to Use the Fittings Table.....	303
AC Fittings Nomenclature.....	304
AC Fittings Overview.....	305

AC (Cool Crimp™) Fittings for Galaxy® G4826 and G4867

Compressor O-Ring Tube.....	310-311
Flareless Tube.....	311-312
Hose Mender.....	313-314
Hose Mender with Sight Glass.....	314
Hose Mender, Tee.....	315
O-Ring Insert.....	315-318
O-Ring Tube.....	318-327
SAE 45° Flare.....	328-330

GC (Cool Clip®) Fittings for Galaxy® G4890

Compressor Pad Block.....	331
Compressor O-Ring Tube.....	332-333
Flareless Tube.....	333-335
Ford Spring Lock.....	335-338
Hose Mender.....	338-340
Hose Mender with Sight Glass.....	340
Hose Mender, Tee.....	340
O-Ring Face Seal.....	341
O-Ring Insert.....	341-344
O-Ring Tube.....	344-350
SAE 45° Flare.....	351-353

AC Adapters

O-Ring Tube Compressor Female to O-Ring Insert.....	354
O-Ring Tube Female to O-Ring Insert.....	354-355
O-Ring Tube Compressor Female to O-Ring Insert.....	355

AC Fitting Accessories

Flareless Tube Nuts.....	356
Flareless Tube Sleeves.....	356
Inline Orifice Tubes.....	357
O-Ring.....	357-358
Sealing Washers.....	358
Valve Adapters.....	358
Valve Caps.....	359
Valve Core.....	359
Metal Clip.....	360
Plastic Clip Holder.....	360
Clip Pliers.....	361
Hose Cutting Tool & Replacement Blades.....	361

Table of Contents

SECTION 9 – UT FITTINGS

Fittings for DUT

How to Use the Fittings Table.....	362
UT Fittings Overview.....	363
JIC 37° Flare (SAE J514).....	364-365
SAE 45° J512 Flare.....	365-366
SAE 45° Inverted Flare.....	367-368
NPTF.....	368
SAE J514 Flareless Tube.....	369
Flange Engine Oil Connection (Two Bolt).....	369
PTT 30°.....	369

SECTION 10 – SPECIALTY FITTINGS

Fittings for NSF, SHR, Hot Oiler, SGUN, SHJ, IG, IGHT, IGTC, FXG

How to Use the Fittings Table.....	370
Specialty Fittings Overview.....	371

SF (NSF) Fittings for Saflex®

JIC 37° Flare (SAE J514).....	372
NPTF.....	372
O-Ring Boss.....	373

Fittings for Prospector™ Slim Hole Rotary

NPT API.....	374
--------------	-----

Fittings for Prospector™ Hot Oiler

Hammer Union.....	374
-------------------	-----

GG (SGUN) Fittings for Grease Gun Hose

NPTF.....	375
-----------	-----

B2 (SHJ) Fittings for Jack Hose

NPTF.....	375
-----------	-----

PB (Push-On Brass) Fittings for Insta-Grip™ and FLEXAGrip™

Hose Mender.....	376
JIC 37° Flare.....	376-377
NPTF.....	378-379
SAE 45° Flare.....	380
SAE 45° Inverted Flare.....	381

SECTION 11 – FERRULES

Uni-Crimp™ and Dual-Grip Ferrules

How to Use the Fittings Table.....	382
UC Fittings Overview.....	382
Uni-Crimp™ UCF2.....	383
Uni-Crimp™ UCF3.....	383
Uni-Crimp™ UCF6.....	384
Uni-Crimp™ UCF8.....	385
Uni-Crimp™ UCF9.....	385
Uni-Crimp™ UCF10.....	386
Uni-Crimp™ UCF11.....	386
Dual-Grip DGF1.....	387
Dual-Grip DGF2.....	387

FITTINGS REFERENCE GUIDES & ACCESSORIES

Choosing the Correct Fittings.....	388
Fittings Working Pressure Guide.....	389
Thread Reference Chart.....	390-391
Fitting Accessories (O-Rings).....	392-393
Split Flanges, Code 61 and Code 62 (SAE J518).....	394
German Metric Thread ID Template.....	395
Code 61, Code 62, CAT® Flange ID Template.....	396
Thread Identification Kit.....	397
Standard and Notched Calipers.....	398

EQUIPMENT & ACCESSORIES

CRIMPERS

PC125M.....	400-401
PC125RCD.....	402-403
PC125PS.....	404-405
PC150H Series.....	406-407
PC150 Series.....	408-409
PC200 Series.....	410-411
PC440 Series.....	412-413
PC600L Crimper.....	414-415
PC1000 Crimper.....	416-417

TEST BENCHES

PCTB-1500.....	418
PCTB-2500.....	418

HOSE SAWS

HS150.....	419
HS150M.....	419
HS501.....	420
HS503.....	420
Blade Awareness.....	421

Hose Reel Rack.....	422
Fittings Cabinet.....	422

ASSEMBLIES

Selecting the Proper Hose Assembly (S.T.A.M.P.E.D.).....	424
S.T.A.M.P.E.D. Form.....	425
Defining Hose & Assembly Length.....	426-427

HOSE ASSEMBLY INSTRUCTIONS

Ultra-Crimp™ 1-Piece Crimped Fittings.....	428-430
Uni-Crimp™ 2-Piece Crimped Fittings.....	431-432
Field-Grip™ Fittings.....	433-434
Internal and External Skiving.....	435
SR14A Hose Assembly.....	436-437
Cool Clip® AC Hose Assembly.....	438
AC Fitting Crimping Procedures.....	439-440

INSTALLATION & MAINTENANCE

Service Life Factors.....	442
Safety Considerations.....	443
Proper Installation & Hose Routing.....	444-445
Hose Maintenance & Storage.....	446

APPENDIX

FITTING IDENTIFICATION

Measuring Threads and Seat Angles.....	448
Measuring Thread Pitch.....	448
Comparing Measurements to the Tables.....	448

FITTING STANDARDS BY THREAD TYPE

North American.....	449-450
North American SAE.....	451-455
British.....	456
French.....	457
German.....	458-463
Japanese.....	464-467

FITTING IDENTIFICATION TEMPLATES

Male Pipe Thread Sizes.....	468
JIC 37° Flare (SAE J514) Thread Sizes.....	468
37° and 45° Flare Nose Angles.....	468
SAE 45° Flare (SAE J512) Thread Sizes.....	468
O-Ring Face Seal (SAE J1453 ORS/ORFS).....	468
Fitting Nuts.....	468

Torque Values.....	470-471
Hose ID Selection Nomograph.....	472-473
Hose Pressure Drop.....	474
Chemical Resistance Tables.....	475-505
Design Considerations.....	506
Standards Certifications.....	507-510
Hose Testing Methods.....	511-512
Electrical Resistance Tests.....	513-516

CONVERSION CHARTS

Elastomer Chart.....	517-518
Temperature Conversion Chart.....	519
Pressure Conversions.....	520
Fraction Equivalents.....	521
Conversion Constants.....	522
Production Run Minimum Requirements.....	523

INDEX

FAMILY PART NUMBER ALPHANUMERIC INDEX

Descriptive Numbers.....	525-530
Product Numbers.....	531-536

HOSE





Hydraulic Hose and Fitting Products

Proper Assembly of Continental Hose and Fittings

Continental hose, fittings and crimping equipment work together to provide an efficient and reliable hose connection. Hose and fittings are part of an engineered system and are to be assembled in accordance with Continental specifications. Using non-Continental components may produce an assembly that does not meet rated performance. **Continental does not warrant, expressly or by implication, hose assemblies that do not incorporate Continental hose and fittings or are not crimped in accordance with Continental process specifications.**

Buyers may elect to attach additional or non-standard parts or equipment, or to use different manufacturing specifications, as necessary to meet the requirements of the buyer or customer's application. In such cases, the buyer has sole responsibility to qualify the hose for these applications as necessary to ensure performance capability.

For guidance in the assembly of Continental hose and couplings, please refer to the Continental Crimp Specifications Manual. Information in this catalog is believed to be accurate, but is not warranted and is subject to change without prior notice. For the most current available product and crimp specifications information, please check our website: www.contitech.us.

Warning - Selection of Hose

Selection of the proper hose for the application is essential to the proper operation and safe use of the hose and related equipment. Inadequate attention to selection of the hose for your application can result in hose leakage, bursting or other failure, which can cause serious bodily injury or property damage from spraying fluids or flying projectiles. Some of the factors involved in the selection of the proper hose include:

- › Hose Size
- › Fluid Conveyed
- › Hose Pressure
- › Hose Length
- › Bends
- › Static Head Pressure
- › Hose Ends
- › Temperature
- › Installation Design

The above factors and information provided in this catalog should be considered in selecting the proper hose for your application.

HOSE

Continental 

Layline Updates

BIGGER, BOLDER, SIMPLER.

Our hydraulic hose laylines have been updated to include the most significant information about the hose, on the hose. Special icons make it quicker and easier to identify a hose's length, corresponding fittings and attributes. To top it off, new logos give more of an edge to our branding.



How to Read a Layline

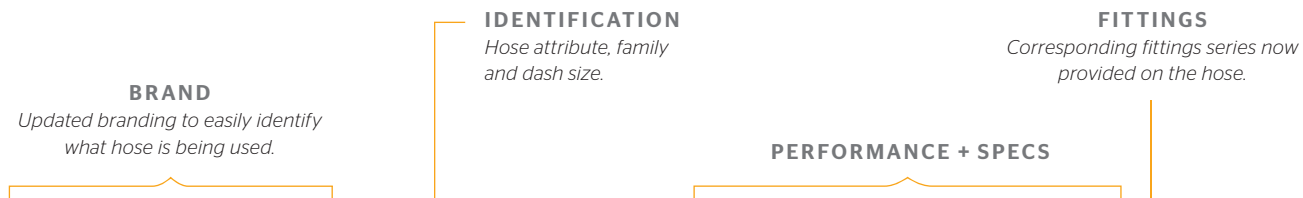

LOOK FOR HIGHLIGHTED ATTRIBUTE
New attribute indicators for key features.

HOSE ATTRIBUTES

- 
High / Low Temperature
- 
Constant Pressure
- 
Extended Life™ Cover
- 
ARMORCOAT™ Resistance
- 
Flame Resistance
- 
Non-Conductive / Conductive
- 
Ultra-Flexible
- 
1/2 Bend Radius

Layline Updates
How to Read a Layline



PART NUMBER DESIGNATIONS

	DESCRIPTION	PAGE
EXTENDED LIFE		
EXTENDED LIFE™ XR16SC	SAE 100R16SC / EN 857 2SC	32
CONSTANT PRESSURE		
EXTENDED LIFE™ XCP3	SAE 100R17 (Constant Pressure 3000 psi)	34
ARMORCOAT™ ACP3	SAE 100R17 (Abrasion Cover)	35
EXTENDED LIFE™ XCP4	SAE 100R19 / ISO 11237	36
ARMORCOAT™ ACP4	SAE 100R19 (Abrasion Cover)	37
EXTENDED LIFE™ XCP3S	SAE 100R12	38
EXTENDED LIFE™ XCP4S	SAE 100R12 / EN 856 4SH	39
EXTENDED LIFE™ XCP5S	SAE 100R13	40
EXTENDED LIFE™ XCP6S	SAE 100R15 / EN 856 4SP	41
ARMORCOAT		
ARMORCOAT™ ARC16SC	SAE 100R16 / EN 857 2SC (Abrasion Cover)	43
ARMORCOAT™ ARC12	SAE 100R12 / EN 856 R12 (Abrasion Cover)	44
ARMORCOAT™ ARC13	SAE 100R13 / EN 856 R13 (Abrasion Cover)	45
ARMORCOAT™ ARC15	SAE 100R15 (Abrasion Cover)	46
HIGH TEMPERATURE		
DESERT® DR1SN	SAE 100R1AT/1SN (High Temperature)	48
DESERT® DR2SN	SAE 100R2AT/2SN (High Temperature)	49
DESERT® DR16SC	SAE 100R16SC (High Temperature)	50
DESERT® DR5	SAE 100R5 (High Temperature, Fleet Application)	51
DESERT® DUT	SAE J1402 A1 (High Temperature, Fleet Application)	52
HR6	SAE 100R6 / EN 854 R6 (High Temperature)	53
LOW TEMPERATURE		
ARCTIC® LR2SN	SAE 100R2AT/2SN (Low Temperature)	55
ARCTIC® LR16SC	SAE 100R16 / EN 857 2SC (Low Temperature)	56
CLASSIC		
SR1SN	SAE 100R1AT/1SN	58
SR2SN	SAE 100R2AT/2SN	59
SR16SC	SAE 100R16 / EN 857 2SC	60
SCP3	SAE 100R17 (Constant Pressure)	61
SR3	SAE 100R3 / EN 854 R3	62
SR5	SAE 100R5 (Fleet Application)	63
SR6	SAE 100R6 / EN 854 R6	64
SR12	SAE 100R12 / EN 856 R12	65
SR13	SAE 100R13 / EN 856 R13	66

	DESCRIPTION	PAGE
CLASSIC <i>Continued</i>		
SR15	SAE 100R15	67
S4SH	EN 856 4SH / DIN 20023 4SH	68
S4SP	EN 856 4SP / DIN 20023 4SP	69
SPECIAL APPLICATION		
SGUN	Grease Gun Hose (Special Application)	71
SHJ	Jack Hose (Special Application)	72
NSFX	Saflex® (Non-Conductive)	73
SR14A	SAE 100R14A (Stainless Steel Cover, Teflon® Tube)	74
SFS	SAE 100R1AT/1SN (Fire Suppression)	75
PROSPECTOR™ BOP 3000	Special Application (Blowout Preventer)	76
PROSPECTOR™ BOP 5000	Very High Pressure (Blowout Preventer)	77
PROSPECTOR™ HOT OILER	Special Application	78
MILITARY		
MIL-DTL-13444H-I	Type I (Military Application)	80
MIL-DTL-13444H-III	Type III (Military Application)	81
MIL-DTL-13531	Type II Class A (Military Application)	82
MIL-DTL-3992	Type I Class 1 (Military Application)	83
MIL-DTL-8788	Hydraulic Hose (Military Application)	84
INSTA-GRIP		
IG	Insta-Grip™ 300 Push-On (Rubber Cover)	86
IGTC	Insta-Grip™ TC Push-On (Textile Cover)	87
IGHT	Insta-Grip™ HT 300 Push-On (High Temperature)	88
FXG	FLEXAGrip™ Push-On (Carbryn® Rubber Cover)	89
AIR CONDITIONING		
GALAXY® G4826	SAE J2064 (Air Conditioning)	91
GALAXY® G4867	SAE J2064 (Air Conditioning)	92
GALAXY® G4890	SAE J2064 (Air Conditioning)	93
THERMOPLASTIC		
SR7	SAE 100R7 / EN 855 R7	95
SR8	SAE 100R8 / EN 855 R8	96
NR7	SAE 100R7 (Non-Conductive)	97
NR8	SAE 100R8 (Non-Conductive)	98
TR7	SAE 100R7 (Twin-Line)	99
TR8	SAE 100R8 (Twin-Line)	100
BR7	SAE 100R7 (Twin-Line, Non-Conductive)	101
SR18	SAE 100R18	102
SUCTION / DISCHARGE		
HR4	SAE 100R4 (High Temperature)	104

Hydraulic Hose Nomenclature

EXAMPLE: **D - R2SN - 12**

HOSE ATTRIBUTE

HOSE SPECIFICATION

HOSE DASH SIZE

First Character of Part Number

H	High Temperature (Desert®), 275°F
L	Low Temperature (Arctic®)
A	Abrasion Cover (Armorcoat™)
N	Non-conductive
T	Twin-Line
B	Both Non-Conductive and Twin-Line
S	Standard Specification Hose
D	High Temperature (Desert®), 302°F
X	Extended Life™ Abrasion Resistance Cover

Note: Push-On Hose (IG, IGHT, IGTC) and Military Hose (MIL, M) do not have a one-digit Hose Attribute character.

Next 2-5 Characters of Part Number, Before Hyphen

R1SN	SAE 100R1AT/1SN
FS	Fire Suppression (SAE 100R1AT/1SN)
R2SN	SAE 100R2AT/2SN
R3	SAE 100R3/EN 854 R3
R4	SAE 100R4
R5	SAE 100R5
UT	Universal Truck Hose (SAE J1402 A1)
R6	SAE 100R6/854 R6
R7	SAE 100R7/855 R7
SFX	Saflex®
R8	SAE 100R8/855 R8
4SH	EN 856 4SH/DIN 20023 4SH
4SP	EN 856 4SP/DIN 20023 4SP
R12	SAE 100R12/856 R12
R13	SAE 100R13/856 R13
R14A	SAE 100R14
R15	SAE 100R15
R16SC	SAE 100R16/857 2SC
CP3	SAE 100R17
CP4	SAE 100R19/ISO 11237
CP5	SAE 100R13
CP6	SAE 100R15/EN 856 4SP
CP3S	SAE 100R12
CP4S	SAE 100R12/EN 856 4SH
CP5S	SAE 100R13
CP6S	SAE 100R13/EN 856 4SP
R18	SAE 100R18
BOP	Prospector™ BOP 3000, 5000
GUN	Grease Gun Hose
HJ	Jack Hose
4826	Galaxy® 4826 (Air Conditioning)
4867	Galaxy® 4867 (Air Conditioning)
4890	Galaxy® 4890 SLE (Air Conditioning)
IG	Insta-Grip™ 300 (Push-On)
IGTC	Insta-Grip™ TC (Push-On)
IGHT	Insta-Grip™ HT 300 (Push-On)
FXG	FLEXAGrip™ (Push-On)
M / MIL	Military Hose

Last 2 Characters of Part Number, After Hyphen (Hose Inside Diameter)

All hose except R5, UT and Galaxy® Hose:

02	1/8" (32 mm)
03	3/16" (4.8 mm)
04	1/4" (6.4 mm)
05	5/16" (7.9 mm)
06	3/8" (9.5 mm)
08	1/2" (12.7 mm)
10	5/8" (15.9 mm)
12	3/4" (19 mm)
16	1" (25.4 mm)
20	1 1/4" (31.8 mm)
24	1 1/2" (38.1 mm)
32	2" (50.8 mm)
40	2 1/2" (63.5 mm)
48	3" (76.2 mm)
56	3 1/2" (89 mm)
64	4" (101.6 mm)

SAE 100R5, UT and Galaxy® Hose:

04	3/16" (4.8 mm)
05	1/4" (6.4 mm)
06	5/16" (7.9 mm)
08	13/32" (10.3 mm)
10	1/2" (12.7 mm)
12	5/8" (15.9 mm)
14	3/4" (19.1 mm)
16	7/8" (22.2 mm)
20	1 1/8" (28.6 mm)
24	1 3/8" (35 mm)
32	1 3/4" (46 mm)

Note: Military Hose utilize unique military dash sizes.

HOSE



General Information

Hose Nomenclature



EXCEEDING HYDRAULIC HOSE STANDARDS

When the job requires tight bends, flexibility and abrasion resistance, this high-pressure service hose steps up to the task. Using a nitrile inner tube and two-wire, high-tensile steel reinforcement, it can handle 5,800 psi (31 MPa) flows of petroleum- and water-based hydraulic fluids.

~~LIFE™~~ EXTENDED LIFE™

	Page	Construction	Inner Tube	Working Pressure (psi)	Temperature Range	Fitting Series	Approvals	Packaging
EXTENDED LIFE™ XR16SC	32	Wire braid	Nitrile	2250–5800	-40°F to 212°F	B2	MSHA, SAE 100R16, EN 857 2S	04-16: 250' Reel; 50' Box; Bulk Carton 20-32: 50', 100' or 200' Coil

~~LIFE™~~ EXTENDED LIFE™

HOSE
Continental

Extended Life™ XR16SC

Extended Life™ XR16SC is for high-pressure service with tight bends needing abrasion resistance and flexibility. It is made for use with petroleum- and water-based hydraulic fluids. This hose has excellent impulse performance and flexibility, exceeding SAE 100R2 and SAE 100R16 standards.



PERFORMANCE + SPECS

Meets or exceeds the performance requirements of:

SAE 100R16
EN 857 2SC

Meets flame resistance
USMSHA Designation

Meets higher
EN/DIN Pressures

Inner Tube NBR (Nitrile)

Reinforcement
Two braids of high-tensile steel wire

Cover
Black synthetic rubber with extra abrasion-, oil- and weather-resistance

Temperature Range
-40°F to 212°F (-40°C to 100°C)

KEY FEATURES

 Extended Life™ Cover

 Made for tight bends

 SAE J1942/
U.S. Coast Guard

 4:1 Safety Factor

BRANDING



X-Life™ XR16SC-08

SAE 100R16 / EN 857 2SC
1/2" (DN12)

5000 PSI
34.5 MPa

MSHA 2G-1C-14C/37

MADE
IN USA

#	SAP	Hose Size ID	Hose OD		Max. Working Pressure		Min. Bend Radius		Weight	Fitting
			in.	mm	psi	MPa	in.	mm		
XR16SC-04	20693982	1/4	0.54	13.70	5800	40.0	2.0	51	0.18	B2
XR16SC-06	20693983	3/8	0.70	17.70	5000	34.5	2.5	64	0.27	B2
XR16SC-08	20693984	1/2	0.81	20.60	5000	34.5	3.5	89	0.36	B2
XR16SC-10	20693985	5/8	0.95	24.20	4350	30.0	4.0	102	0.41	B2
XR16SC-12	20693987	3/4	1.10	28.00	3500	24.1	5.0	127	0.55	B2
XR16SC-16	20693988	1	1.40	35.50	3000	20.6	6.0	152	0.83	B2
XR16SC-20	20899538	1 1/4	1.74	44.3	2250	15.5	8.25	210	1.12	B2
XR16SC-24	21010293	1 1/2	1.98	50.3	2000	13.8	9.84	250	1.31	B2
XR16SC-32	21010296	2	2.52	64.1	1600	11.0	12.52	318	1.83	B2

HOSE



Extended Life™ XR16SC
High Pressure

Compatible Fittings

All fittings compatible with XR16SC are listed in Section 1 (starting on page 131).



CONSISTENT PERFORMANCE UNDER PRESSURE



CONSTANT PRESSURE

	Page	Construction	Inner Tube	Working Pressure (psi)	Temperature Range	Fitting Series	Approvals	Packaging
BRAID								
EXTENDED LIFE™ XCP3	34	Wire braid	Nitrile	3250	-40°F to 212°F	B2	MSHA, SAE 100R17, USCG	250' or 1000' Reel; 50' Box; Bulk Carton
ARMORCOAT™ ACP3	35	Wire braid	Nitrile	3250	-40°F to 212°F	B2	MSHA, SAE 100R17	250' Reel; 250' Box; Bulk Carton
EXTENDED LIFE™ XCP4	36	Wire braid	Nitrile	4060	-40°F to 212°F	B2	MSHA, SAE 100R19, ISO 11237 R19	250' Reel; 50' Box
ARMORCOAT™ ACP4	37	Wire braid	Nitrile	4060	-40°F to 212°F	B2	MSHA, SAE 100R19	250' Reel; 250' Box
SPIRAL								
XCP3S	38	Spiral	Synthetic Rubber	3100	-40°F to 250°F	SG	MSHA, SAE 100R12	50', 100' or 200' Coil
XCP4S	39	Spiral	Synthetic Rubber	4100	-40°F to 250°F	SG	MSHA, SAE 100R12, EN 856 4SH	50', 100' or 200' Coil
XCP5S	40	Spiral	Synthetic Rubber	5100	-40°F to 250°F	SG	MSHA, SAE 100R13	50', 100' or 200' Coil
XCP6S	41	Spiral	Synthetic Rubber	6100	-40°F to 250°F	SG	MSHA, SAE 100R15, EN 856 4SP	50', 100' or 200' Coil



CONSTANT PRESSURE

HOSE

Extended Life™ XCP3

Extended Life™ XCP3 is for high-pressure hydraulic applications needing abrasion resistance. This hose is designed for use where higher pressures and a more flexible hose are required.



PERFORMANCE + SPECS

Meets or exceeds the performance requirements of:

SAE 100R17

Meets flame resistance

USMSHA Designation

Inner Tube

(NBR) Nitrile

Reinforcement

One braid of high-tensile steel wire. Sizes 5/8", 3/4" and 1" have a 2-wire braid.

Cover

Black synthetic rubber with extra abrasion-, oil- and weather-resistance (more than 5 times the abrasion resistance over SCP3)

Temperature Range

-40°F to 212°F (-40°C to 100°C)

KEY FEATURES

 **Extended Life™ Cover**

 **Handles constant pressure**

 **SAE J1942/ U.S. Coast Guard**

 **4:1 Safety Factor**

 **500,000 impulse cycles tested**

BRANDING



X-Life™ XCP3-08

SAE 100R17 / EN 857 2SC
1/2" (DN12)

3250 PSI
22.4 MPa

MSHA 2G-1C-14C/37

MADE
IN USA

#	SAP	Hose Size ID	Hose OD	Max. Working Pressure	Min. Bend Radius	Weight	Fitting			
Part Number	SAP Number	in.	in.	mm	psi	MPa	in.	mm	lbs./ft.	
XCP3-04	20738196	1/4	0.50	12.7	3250	22.4	1.5	38	0.11	B2
XCP3-06	20784065	3/8	0.65	16.5	3250	22.4	2.0	51	0.17	B2
XCP3-08	20774712	1/2	0.78	19.8	3250	22.4	2.8	71	0.28	B2
XCP3-10	20777228	5/8	0.95	24.1	3250	22.4	3.0	76	0.41	B2
XCP3-12	20777501	3/4	1.13	28.7	3250	22.4	3.8	97	0.55	B2
XCP3-16	20774714	1	1.44	36.6	3250	22.4	4.5	114	0.82	B2

HOSE



Extended Life™ XCP3

Constant Pressure / High Pressure

Compatible Fittings

All fittings compatible with Extended Life™ XCP3 are listed in Section 1 (starting on page 131).

Armorcoat™ ACP3

Armorcoat™ ACP3 is made for high-pressure hydraulic applications designed to replace SAE 100R17 where higher pressures, increased flexibility and maximum abrasion resistance are required.



PERFORMANCE + SPECS

Meets or exceeds the performance requirements of:

SAE 100R17

Meets flame resistance

USMSHA Designation

Inner Tube

NBR (Nitrile)

Reinforcement

One braid of high-tensile steel wire
 Sizes 5/8", 3/4" and 1" have a 2-wire braid.

Cover

Black synthetic rubber with Armorcoat™

Temperature Range

-40°F to 212°F (-40°C to 100°C)

KEY FEATURES

-  **Armorcoat™ abrasion-resistant cover**
-  **Handles constant pressure**
-  **4:1 Safety Factor**
-  **500,000 impulse cycles tested**

BRANDING

 **ARMORCOAT™ ACP3-08** SAE 100R17 Super Abrasion Cover 1/2" (DN12) **3250 PSI** 22.4 MPa 224 BAR **MSHA 2G-1C-14C/43** MADE IN USA

#	SAP	Hose Size ID	Hose OD	Max. Working Pressure	Min. Bend Radius	Weight	Fitting			
Part Number	SAP Number	in.	in.	mm	psi	MPa	in.	mm	lbs./ft.	
ACP3-04	20706539	1/4	0.50	12.8	3250	22.4	1.5	38	0.11	B2
ACP3-06	20706643	3/8	0.65	16.5	3250	22.4	2.0	51	0.17	B2
ACP3-08	20706648	1/2	0.79	19.9	3250	22.4	2.8	71	0.28	B2
ACP3-10	20870407	5/8	0.95	24.1	3250	22.4	3.0	76	0.41	B2
ACP3-12	21002020	3/4	1.13	28.7	3250	22.4	3.8	96.5	0.53	B2
ACP3-16	21002025	1	1.44	36.6	3250	22.4	4.5	114.3	0.92	B2

Armorcoat™ ACP3
 High Pressure

Compatible Fittings

All fittings compatible with Armorcoat™ ACP3 are listed in Section 1 (starting on page 131).

Extended Life™ XCP4

Extended Life™ XCP4 is made for very high-pressure hydraulic applications requiring extra abrasion resistance. This hose has excellent impulse performance and flexibility.



PERFORMANCE + SPECS

Meets or exceeds the performance requirements of:

SAE 100R19
ISO 11237 R19

Meets flame resistance
USMSHA Designation

SAE J1942/U.S. Coast Guard

Inner Tube NBR (Nitrile)

Reinforcement

Two braids of high-tensile steel wire

Cover

Black synthetic rubber with superior abrasion-, oil- and weather-resistance

Temperature Range

-40°F to 212°F (-40°C to 100°C)

KEY FEATURES

~~X~~LIFE™ Extended Life™ Cover

 Handles constant pressure

 4:1 Safety Factor

BRANDING



X-Life™ XCP4-08

SAE 100R16
ISO 11237 / R19 12.5

4060 PSI 28.0 MPa
280 BAR

MSHA 2G-1C-14C/37

MADE
IN USA

#	SAP	Hose Size ID	Hose OD	Max. Working Pressure	Min. Bend Radius	Weight	Fitting			
Part Number	SAP Number	in.	in.	mm	psi	MPa	in.	mm	lbs./ft.	
XCP4-04	20827919	1/4	0.54	13.8	4060	28	2.0	50.8	0.26	B2
XCP4-06	20826087	3/8	0.69	17.6	4060	28	2.5	63.5	0.30	B2
XCP4-08	20828100	1/2	0.82	20.9	4060	28	3.5	88.9	0.42	B2
XCP4-10	20828101	5/8	0.95	24.2	4060	28	4.0	101.6	0.48	B2
XCP4-12	20826123	3/4	1.14	29.0	4060	28	5.0	127.0	0.66	B2

HOSE



Extended Life™ XCP4

Constant Pressure / Very High Pressure

Compatible Fittings

All fittings compatible with XCP4 are listed in Section 1 (starting on page 131).

Armorcoat™ ACP4

Armorcoat™ ACP4 is made for very high-pressure hydraulic applications where maximum abrasion resistance is required. This hose has excellent impulse performance and flexibility.



PERFORMANCE + SPECS

Meets or exceeds the performance requirements of:

SAE 100R19
ISO 11237

Meets flame resistance
USMSHA Designation

Inner Tube
NBR (Nitrile)

Reinforcement

Two braids of high-tensile steel wire

Cover

Black synthetic rubber with Armorcoat™

Temperature Range

-40°F to 212°F (-40°C to 100°C)

KEY FEATURES

 **Armorcoat™**
abrasion-resistant cover

 **Handles**
constant pressure

 **4:1** 4:1 Safety Factor

 **Tested and validated to**
500,000 impulse cycles
per SAE 100R19

BRANDING



ARMORCOAT™ ACP4-08

SAE 100R19 / ISO 11237 R19 12.5
Super Abrasion Cover

4060 PSI 28.0 MPa
280 BAR

MSHA 2G-1C-14C/37

MADE
IN USA

#	SAP	Hose Size ID	Hose OD	Max. Working Pressure	Min. Bend Radius	Weight	Fitting			
Part Number	SAP Number	in.	in.	mm	psi	MPa	in.	mm	lbs./ft.	
ACP4-04	20932847	1/4	0.54	13.8	4060	28	2.0	50.8	0.26	B2
ACP4-06	20932924	3/8	0.69	17.6	4060	28	2.5	63.5	0.30	B2
ACP4-08	20932946	1/2	0.82	20.9	4060	28	3.5	88.9	0.42	B2
ACP4-10	20932980	5/8	0.95	24.2	4060	28	4.0	101.6	0.48	B2
ACP4-12	20932986	3/4	1.14	29.0	4060	28	5.0	127.0	0.66	B2

Armorcoat™ ACP4
High Pressure

Compatible Fittings

All fittings compatible with Armorcoat™ ACP4 are listed in Section 1 (starting on page 131).

HOSE



XCP3S

XCP3S is made for high-pressure hydraulic applications requiring extra abrasion resistance. This hose has excellent impulse performance and flexibility.



PERFORMANCE + SPECS

Meets or exceeds the performance requirements of: **SAE 100R12**

Bend radius up to 1/2 that of SAE

Flame-resistant **MSHA compliant cover**

Color-coded pressure range system for easy identification

XCP3S Maximum Working Pressure 3100 psi

Inner Tube

Synthetic rubber

Reinforcement

Four alternating layers of spiraled high-tensile wire

Cover

Black synthetic rubber with extra abrasion-, oil- and weather-resistance

Temperature Range

-40°F to 250°F (-40°C to 131°C)

KEY FEATURES

~~X-LIFE™~~ Extended Life™ Cover









 Handles constant pressure

 1/2 Bend

 4:1 Safety Factor

BRANDING

 **X-Life™ XCP3S-20** SAE 100R12 1 1/4" (R12) **3100 PSI** 21 MPa 213.73 BAR Flame Resistant **MSHA 2G-1C-14C/45**

										
Part Number	SAP Number	Hose Size ID	Hose OD		Max. Working Pressure		Min. Bend Radius		Weight	Fitting
		in.	in.	mm	psi	MPa	in.	mm	lbs./ft.	
XCP3S-20	20901269	1 ¼	1.85	47.0	3100	21	16.5	420	1.70	SG
XCP3S-24	20921135	1 ½	2.11	53.5	3100	21	19.6	500	2.05	SG
XCP3S-32	20921137	2	2.63	66.7	3100	21	24.8	630	2.82	SG

HOSE



XCP3S

Constant Pressure / High Pressure

Compatible Fittings

All fittings compatible with XCP3S are listed in Section 2 (starting on page 179).

XCP4S

XCP4S is for very high-pressure hydraulic applications requiring extra abrasion resistance. It has excellent impulse performance and flexibility.

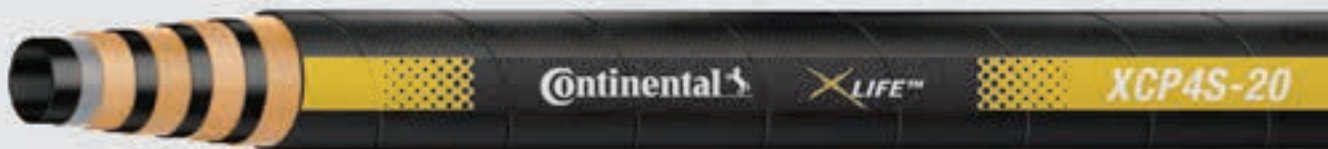

PERFORMANCE + SPECS

Meets or exceeds the performance requirements of: **SAE 100R12, EN 856 4SH**

Bend radius up to 1/2 that of SAE

Flame-resistant **MSHA compliant cover**

Color-coded pressure range system for easy identification

XCP4S Maximum Working Pressure 4100 psi

Inner Tube
Synthetic rubber

Reinforcement
Four or six alternating layers of spiraled high-tensile steel wire

Cover
Black synthetic rubber with extra abrasion-, oil- and weather-resistance

Temperature Range
-40°F to 250°F (-40°C to 131°C)

KEY FEATURES

~~X-LIFE™~~ Extended Life™ Cover

Handles constant pressure

1/2 Bend

4:1 Safety Factor

BRANDING

X-Life™ XCP4S-08 SAE 100R12 / EN 856 1 1/4" (R12) **4100 PSI** 21 MPa 213.73 BAR **MSHA 2G-1C-14C/45**

Part Number	SAP Number	Hose Size ID	Hose OD	Max. Working Pressure	Min. Bend Radius	Weight	Fitting			
		in.	in.	mm	psi	MPa	in.	mm	lbs./ft.	
XCP4S-06	20854290	3/8	0.80	20.25	4100	28	2.6	65	0.40	SG
XCP4S-08	20854291	1/2	0.94	23.8	4100	28	3.5	90	0.52	SG
XCP4S-10	20854292	5/8	1.08	27.4	4100	28	3.9	100	0.70	SG
XCP4S-12	20854293	3/4	1.21	30.7	4100	28	4.7	120	0.90	SG
XCP4S-16	20864021	1	1.50	38.0	4100	28	5.9	150	1.20	SG
XCP4S-20	20867345	1 1/4	1.79	45.5	4100	28	10.6	270	1.71	SG
XCP4S-24	20867346	1 1/2	2.11	53.5	4100	28	13.0	330	2.19	SG
XCP4S-32	20882961	2	2.59	65.9	4100	28	24.8	630	3.23	SG

XCP4S

Constant Pressure / Very High Pressure

Compatible Fittings

All fittings compatible with XCP4S are listed in Section 2 (starting on page 179).

HOSE



XCP5S

XCP5S is made for very high-pressure hydraulic applications requiring extra abrasion resistance. This hose has excellent impulse performance and flexibility.



PERFORMANCE + SPECS

Meets or exceeds the performance requirements of: **SAE 100R13**

Bend radius up to 1/2 that of SAE

Flame-resistant **MSHA compliant cover**

Color-coded pressure range system for easy identification

XCP5S Maximum Working Pressure 5100 psi

Inner Tube

Synthetic rubber

Reinforcement

Four or six alternating layers of spiraled high-tensile steel wire

Cover

Black synthetic rubber with extra abrasion-, oil- and weather-resistance

Temperature Range

-40°F to 250°F (-40°C to 131°C)

KEY FEATURES

X-LIFE™ Extended Life™ Cover

 Handles constant pressure

 1/2 Bend

 4:1 Safety Factor

BRANDING

 **X-Life™ XCP5S-08** SAE 100R12 / EN 856 1 1/4" (R12) **5100 PSI** 35 MPa 350 BAR Flame Resistant **MSHA 2G-1C-14C/45**

#	SAP	Hose Size ID	Hose OD	Max. Working Pressure	Min. Bend Radius	Weight	Fitting			
Part Number	SAP Number	in.	in.	mm	psi	MPa	in.	mm	lbs./ft.	
XCP5S-06	20882963	3/8	0.84	21.4	5100	35	3.5	90	0.48	SG
XCP5S-08	20879434	1/2	0.97	24.6	5100	35	3.5	90	0.58	SG
XCP5S-10	20882965	5/8	1.11	28.2	5100	35	4.7	120	0.79	SG
XCP5S-12	20864025	3/4	1.27	32.2	5100	35	4.7	120	0.98	SG
XCP5S-16	20867348	1	1.52	38.7	5100	35	5.9	150	1.42	SG
XCP5S-20	20879437	1 1/4	1.79	45.5	5100	35	10.7	270	1.71	SG
XCP5S-24	20864029	1 1/2	2.28	57.8	5100	35	19.6	500	3.35	S6, SE
XCP5S-32	20867503	2	2.80	71.1	5100	35	24.8	630	4.76	S6, SE

HOSE



XCP5S

Constant Pressure / Very High Pressure

Compatible Fittings

SG fittings are listed in Section 2 (page 179).

S6 fittings are listed in Section 3 (page 216).

XCP6S

XCP6S is for very high-pressure hydraulic applications requiring extra abrasion resistance. It has excellent impulse performance and flexibility.

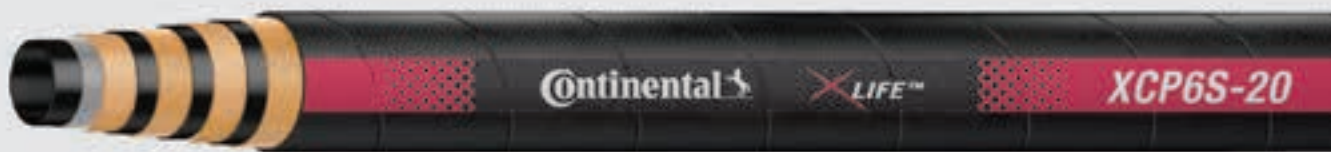

PERFORMANCE + SPECS

Meets or exceeds the performance requirements of: **SAE 100R15, EN 856 4SP**

Bend radius up to 1/2 that of SAE

Flame-resistant **MSHA compliant cover**

Color-coded pressure range system for easy identification

XCP6S Maximum Working Pressure 6100 psi

Inner Tube
Synthetic rubber

Reinforcement
Four or six alternating layers of spiraled high-tensile steel wire

Cover
Black synthetic rubber with extra abrasion-, oil- and weather-resistance

Temperature Range
-40°F to 250°F (-40°C to 131°C)

KEY FEATURES

X-LIFE™ Extended Life™ Cover

 Handles constant pressure

 1/2 Bend

 4:1 Safety Factor

BRANDING











X-Life™ XCP6S-08

SAE 100R15 / EN 856 1/2" (R15)

6100 PSI 42 MPa 420 BAR

Flame Resistant

MSHA 2G-1C-14C/45

										
Part Number	SAP Number	Hose Size ID	Hose OD	Max. Working Pressure	Min. Bend Radius	Weight	Fitting			
		in.	in.	mm	psi	MPa	in.	mm	lbs./ft.	
XCP6S-06	20882967	3/8	0.84	21.4	6100	42	3.5	90	0.48	SG
XCP6S-08	20879438	1/2	0.97	24.6	6100	42	3.5	90	0.58	SG
XCP6S-10	20889839	5/8	1.04	26.5	6100	42	4.7	120	0.73	SG
XCP6S-12	20864030	3/4	1.27	32.2	6100	42	4.7	120	1.09	SG
XCP6S-16	20879440	1	1.53	38.9	6100	42	5.9	150	1.46	SG
XCP6S-20	20882970*	1 1/4	2.03	51.5	6100	42	17.5	445	2.41	SG
XCP6S-24	20864033	1 1/2	2.20	55.8	6100	42	20.8	530	3.02	SE
XCP6S-32	20880050	2	2.86	72.7	6100	42	24.8	630	2.20	SE

XCP6S

Constant Pressure / Very High Pressure

Compatible Fittings

SG fittings are listed in Section 2 (page 179).
SE fittings are listed in Section 3 (page 216).

HOSE





ABRASION IS THE ENEMY. FIGHT IT FULLY ARMED.



ARMORCOAT™

	Page	Construction	Inner Tube	Working Pressure (psi)	Temperature Range	Fitting Series	Approvals	Packaging
ARMORCOAT™ ARC16SC	43	Wire braid	Nitrile	3000-5800	-40°F to 212°F	B2	MSHA, SAE 100R16, EN 857 2SC	250' Reel; 50' or 250' Box
ARMORCOAT™ ARC12	44	Wire braid	Polychloroprene	2550-4100	-40°F to 250°F	B2, SG	MSHA, SAE 100R12, EN 856 R12	50', 100' or 200' Coil
ARMORCOAT™ ARC13	45	Wire braid	Polychloroprene	5100	-40°F to 250°F	SG, S6, DG	MSHA, SAE 100R13, EN 856 R13	50', 100' or 200' Coil
ARMORCOAT™ ARC15	46	Wire braid	Polychloroprene	6100	-40°F to 250°F	SG	MSHA, SAE 100R15	50', 100' or 200' Coil

HOSE

Continental



ARMORCOAT™

Armorcoat™ ARC16SC

Armorcoat™ ARC16SC is made for high-pressure service with tight bends for petroleum- and water-based hydraulic fluids where maximum abrasion resistance is required. This hose has excellent impulse performance and flexibility exceeding SAE 100R2 and SAE 100R16 standards.



PERFORMANCE + SPECS

Meets or exceeds the performance requirements of:

SAE 100R16
EN 857 2SC

Meets flame resistance
USMSHA Designation

Meets higher
EN/DIN Pressures

Inner Tube
NBR (Nitrile)

Reinforcement
Two braids of high-tensile steel wire

Cover
Black synthetic rubber with Armorcoat™

Temperature Range
-40°F to 212°F (-40°C to 100°C)

KEY FEATURES

 Armorcoat™ abrasion-resistant cover

 4:1 Safety Factor

BRANDING

 **ARMORCOAT™ ARC16SC-08** SAE 100R16 / EN 857 2SC Super Abrasion Cover 1/2" (DN12) **5000 PSI** 34.5 MPa 345 BAR **MSHA 2G-1C-14C/43** **MADE IN USA**

#	SAP	Hose Size ID	Hose OD	Max. Working Pressure	Min. Bend Radius	Weight	Fitting			
Part Number	SAP Number	in.	in.	mm	psi	MPa	in.	mm	lbs./ft.	
ARC16SC-04	20731686	1/4	0.52	13.2	5800	40.0	2.0	51	0.17	B2
ARC16SC-06	20731831	3/8	0.67	17.0	5000	34.5	2.5	64	0.26	B2
ARC16SC-08	20730593	1/2	0.81	20.6	5000	34.5	3.5	89	0.35	B2
ARC16SC-10	20733777	5/8	0.92	23.4	4350	30.0	4.0	102	0.40	B2
ARC16SC-12	20733779	3/4	1.08	27.4	3500	24.1	5.0	127	0.54	B2
ARC16SC-16	20731835	1	1.40	35.5	3000	20.6	6.0	152	0.83	B2

Armorcoat™ ARC16SC
High Pressure

Compatible Fittings

All fittings compatible with ARC16SC are listed in Section 1 (starting on page 131).

HOSE



Armorcoat™ ARC12

Armorcoat™ ARC12 is for very high-pressure applications subject to surges or flexing, such as construction equipment, mining and the high-performance industrial market where maximum abrasion resistance is required.



PERFORMANCE + SPECS

Meets or exceeds the performance requirements of:

SAE 100R12
EN 856 R12

Meets flame resistance
USMSHA Designation

Inner Tube
CR (Polychloroprene)

Reinforcement

Four alternating layers of spiraled high-tensile steel wire

Cover

Black synthetic rubber with Armorcoat™

Temperature Range

-40°F to 250°F (-40°C to 121°C)

KEY FEATURES

 **Armorcoat™**
abrasion-resistant cover

 **1/2 Bend (3/8" - 3/4")**

 **4:1** 4:1 Safety Factor

BRANDING



ARMORCOAT™ ARC12-08

SAE 100R12 / EN 856
Abrasion Cover

1/2"
(DN12)

4100 PSI 28 MPa
280 BAR

MSHA 2G-1C-14C/37

#	SAP	Hose Size ID	Hose OD		Max. Working Pressure		Min. Bend Radius		Weight	Fitting
Part Number	SAP Number	in.	in.	mm	psi	MPa	in.	mm	lbs./ft.	
ARC12-06	20729168	3/8	0.80	20.2	4100	28.0	2.5	64	0.44	SG
ARC12-08	20715104	1/2	0.94	23.8	4100	28.0	3.5	90	0.55	SG
ARC12-10	20729176	5/8	1.11	28.2	4100	28.0	3.9	100	0.72	SG
ARC12-12	20729170	3/4	1.21	30.7	4100	28.0	4.7	120	0.82	SG
ARC12-16	20715107	1	1.50	38.0	4100	28.0	11.8	300	1.21	SG
ARC12-20	20729173	1 ¼	1.85	47.0	3050	21.0	16.5	420	1.65	B2
ARC12-24	20729174	1 ½	2.10	53.4	2550	17.6	19.7	500	2.19	B2
ARC12-32	20729175	2	2.63	66.7	2550	17.6	25.0	635	3.13	B2

HOSE



Armorcoat™ ARC12

Very High Pressure

Compatible Fittings

B2 fittings can be found in Section 1 (page 131).

SG fittings can be found in Section 2 (page 179).

Armorcoat™ ARC13

Armorcoat™ ARC13 is for very high-pressure applications subject to surges or flexing, such as construction equipment, mining and the high-performance industrial market where maximum abrasion resistance is required.

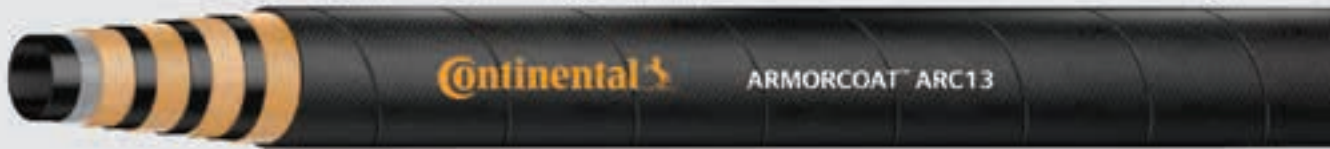

PERFORMANCE + SPECS

Meets or exceeds the performance requirements of:

SAE 100R13
EN 856 R13

Meets flame resistance
USMSHA Designation

Inner Tube
CR (Polychloroprene)

Reinforcement

Four alternating layers of spiraled high-tensile steel wire (sizes 3/4" and 1")

Six alternating layers of spiraled high-tensile steel wire (sizes 1¼", 1½" and 2")

Cover

Black synthetic rubber with Armorcoat™

Temperature Range

-40°F to 250°F (-40°C to 121°C)

KEY FEATURES

 **Armorcoat™**
abrasion-resistant cover

 **4:1** 4:1 Safety Factor

BRANDING

 **ARMORCOAT™ ARC13-12** SAE 100R13 / EN 856 Abrasion Cover 3/4" (DN19) **5100 PSI** 35 MPa 350 BAR **MSHA 2G-1C-14C/37**

#	SAP	Hose Size ID	Hose OD		Max. Working Pressure		Min. Bend Radius		Weight	Fitting
Part Number	SAP Number	in.	in.	mm	psi	MPa	in.	mm	lbs./ft.	
ARC13-12	20715111	3/4	1.26	32.1	5100	35.0	9.5	240	0.97	SG
ARC13-16	20715112	1	1.51	38.5	5100	35.0	11.8	305	1.30	SG
ARC13-20	20715113	1¼	1.96	49.8	5100	35.0	16.5	420	1.73	S6
ARC13-24	20715114	1½	2.26	57.3	5100	35.0	19.7	500	3.27	DG
ARC13-32	20715115	2	2.80	71.1	5100	35.0	25.2	640	4.43	N/A

Armorcoat™ ARC13
Very High Pressure

Compatible Fittings

SG fittings are listed in Section 2 (starting on page 179).
S6 and DG fittings are listed in Section 3 (page 216).

HOSE



Armorcoat™ ARC15

Armorcoat™ ARC15 is designed specifically to handle severe high-pressure applications where pressure spikes or constant hydrostatic loads are present and maximum abrasion resistance is required.



PERFORMANCE + SPECS

Meets or exceeds the performance requirements of:

SAE 100R15

Meets flame resistance

USMSHA Designation

Inner Tube

CR (Polychloroprene)

Reinforcement

Four alternating layers of spiraled high-tensile steel wire

Cover

Black synthetic rubber with Armorcoat™

Temperature Range

-40°F to 250°F (-40°C to 121°C)

KEY FEATURES



Armorcoat™
abrasion-resistant cover



4:1 Safety Factor

BRANDING



ARMORCOAT™ ARC15-08

SAE 100R15
Abrasion Cover

1/2"
(DN12)

6100 PSI 42 MPa
420 BAR

MSHA 2G-1C-14C/43

#	SAP	Hose Size ID	Hose OD		Max. Working Pressure		Min. Bend Radius		Weight	Fitting
Part Number	SAP Number	in.	in.	mm	psi	MPa	in.	mm	lbs./ft.	
ARC15-08	20714906	1/2	1.06	26.8	6100	42.0	8.0	200	0.59	N/A
ARC15-12	20714907	3/4	1.27	32.2	6100	42.0	10.5	265	1.08	SG
ARC15-16	20714908	1	1.53	38.8	6100	42.0	13.0	330	1.48	SG

HOSE



Armorcoat™ ARC15

Very High Pressure

Compatible Fittings

All fittings compatible with Armorcoat™ ARC15 are listed in Section 2 (starting on page 179).



HIGHER TEMPERATURES ARE NO SWEAT

DESERT HIGH TEMPERATURE

	Page	Construction	Inner Tube	Working Pressure (psi)	Temperature Range	Fitting Series	Approvals	Packaging
DR1SN	48	Wire braid	Chlorinated Polyethylene	580-5075	-40°F to 302°F	B2	MSHA, SAE 100R1AT, USCG	04-16: 250' Reel 20-32: 100' Coil
DR2SN	49	Wire braid	Chlorinated Polyethylene	1160-5800	-40°F to 302°F	B2	MSHA, SAE 100R2AT, EN 853 2SN, USCG	04-16: 250' Reel; 50' Box 20-32: 50' or 100' Coil
DR16SC	50	Wire braid	Chlorinated Polyethylene	3000-5075	-40°F to 302°F	B2	MSHA, SAE 100R16, EN 857 2SC, USCG	250' Reel
DR5	51	Wire braid	Chlorinated Polyethylene	350-3000	-40°F to 302°F Hydraulic	UC, FG	SAE 100R5, SAE J1402, DOT FMVSS 106	04-20: 250' Reel; 50' Box 20-32: 131' Coil
DUT	52	Wire braid	Chlorinated Polyethylene	300-2000	-40°F to 200°F General Air	UT	SAE J1402, DOT FMVSS 106	250' Reel; 50' Box
HR6	53	Textile braid	Nitrile	300-400	-40°F to 275°F	UC	SAE 100R6, EN 854 R6	500' Reel; 50' Box

DESERT HIGH TEMPERATURE

HOSE
Continental

Desert® DR1SN

Desert® DR1SN is for medium-pressure hydraulic oil lines used in mobile, machine tool and agricultural applications where higher temperature petroleum- or water-based hydraulic fluids are a factor.



PERFORMANCE + SPECS

Meets or exceeds the performance requirements of:

SAE 100R1AT
EN 853 1SN

Meets flame resistance
USMSHA Designation

Meets higher
EN/DIN Pressures

Inner Tube

CPE (Chlorinated Polyethylene)

Reinforcement

One braid of high-tensile steel wire

Cover

Blue CPE (Chlorinated Polyethylene)

Temperature Range

-40°F to 302°F (-40°C to 150°C)

KEY FEATURES



Handles high temperature



SAE J1942/
U.S. Coast Guard



4:1 Safety Factor

BRANDING



DESERT® 2.0 DR1SN-08

SAE 100R1AT / 1SN
1/2" (DN12)

4500 PSI 16 MPA
160 BAR

MSHA 2G-1C-14C/37

MADE
IN USA

#	SAP	Hose Size ID	Hose OD		Max. Working Pressure		Min. Bend Radius		Weight	Fitting
Part Number	SAP Number	in.	in.	mm	psi	MPa	in.	mm	lbs./ft.	
DR1SN-04	20786856	1/4	0.52	13.1	3270	22.5	4.0	102	0.15	B2
DR1SN-06	20777151	3/8	0.67	17.1	2615	18.0	5.0	127	0.22	B2
DR1SN-08	20752562	1/2	0.80	20.3	2320	16.0	7.0	178	0.28	B2
DR1SN-10	20777159	5/8	0.92	23.4	1890	13.0	8.0	203	0.33	B2
DR1SN-12	20780193	3/4	1.08	27.4	1530	10.5	9.5	241	0.41	B2
DR1SN-16	20777155	1	1.39	35.3	1280	8.8	12.0	305	0.62	B2
DR1SN-20	20776244	1 ¼	1.70	43.1	920	6.3	16.5	419	0.84	B2
DR1SN-24	20776245	1 ½	1.97	50.1	730	5.0	20.0	508	1.09	B2
DR1SN-32	20776246	2	2.50	63.6	580	4.0	25.0	635	1.34	B2

HOSE



Desert® DR1SN

Medium Pressure

Compatible Fittings

All fittings compatible with Desert® DR1SN are listed in Section 1 (starting on page 131).

Desert® DR2SN

Desert® DR2SN is for high-pressure hydraulic oil lines used in construction, machine tool and agricultural applications where higher temperature petroleum- or water-based hydraulic fluids are a factor.



PERFORMANCE + SPECS

Meets or exceeds the performance requirements of:

SAE 100R2AT
EN 853 2SN

Meets flame resistance
USMSHA Designation

Meets higher
EN/DIN Pressures

Inner Tube

CPE (Chlorinated Polyethylene)

Reinforcement

Two braids of high-tensile steel wire

Cover

Blue CPE (Chlorinated Polyethylene)

Temperature Range

-40°F to 302°F (-40°C to 150°C)

KEY FEATURES

-  Handles high temperature
-  SAE J1942/
U.S. Coast Guard
-  4:1 Safety Factor

BRANDING

 **DESERT® 2.0 DR2SN-08** SAE 100R2AT 1/2" (DN12) **4000 PSI** 27.6 MPa 275.8 BAR **MSHA 2G-1C-14C/37** MADE IN USA

#	SAP	Hose Size ID	Hose OD	Max. Working Pressure	Min. Bend Radius	Weight	Fitting			
Part Number	SAP Number	in.	in.	mm	psi	MPa	in.	mm	lbs./ft.	
DR2SN-04	20698338	1/4	0.59	15.1	5800	40.0	4.0	102	0.24	B2
DR2SN-06	20698339	3/8	0.75	19.1	4800	33.1	5.0	127	0.34	B2
DR2SN-08	20698620	1/2	0.88	22.2	4000	27.6	7.0	178	0.43	B2
DR2SN-10	20698621	5/8	1.00	25.4	3630	25.0	8.0	203	0.50	B2
DR2SN-12	20698622	3/4	1.16	29.4	3120	21.5	9.5	241	0.61	B2
DR2SN-16	20698623	1	1.50	38.1	2400	16.5	12.0	305	0.88	B2
DR2SN-20	20732342	1 ¼	1.88	47.7	1820	12.5	16.5	419	1.52	B2
DR2SN-24	20732343	1 ½	2.13	54.1	1310	9.0	20.0	508	1.64	B2
DR2SN-32	20732344	2	2.63	66.7	1160	8.0	25.0	635	2.02	B2

Desert® DR2SN
High Pressure

Compatible Fittings

All fittings compatible with Desert® DR2SN are listed in Section 1 (starting on page 131).

Desert® DR16SC

Desert® DR16SC is for high-pressure service with tight bends using petroleum- and water-based hydraulic fluids. It is meant for high temperature applications.



PERFORMANCE + SPECS

Meets or exceeds the performance requirements of:

SAE 100R16
EN 857 2SC

Meets flame resistance
USMSHA Designation

Meets higher
EN/DIN Pressures

Inner Tube

CPE (Chlorinated Polyethylene)

Reinforcement

Two braids of high-tensile steel wire





Cover

Blue CPE (Chlorinated Polyethylene)

Temperature Range

-40°F to 302°F (-40°C to 150°C)

KEY FEATURES

-  Handles high temperature
-  Made for tight bends
-  SAE J1942/
U.S. Coast Guard
-  4:1 Safety Factor

BRANDING



DESERT® 2.0 DR16SC-08

SAE 100R16
1/2" (DN12)

4500 PSI 34.5 MPa
34.7 BAR

MSHA 2G-1C-14C/42

MADE
IN USA

#	SAP	Hose Size ID	Hose OD		Max. Working Pressure		Min. Bend Radius		Weight	Fitting
Part Number	SAP Number	in.	in.	mm	psi	MPa	in.	mm	lbs./ft.	
DR16-04*	20778355	1/4	0.54	18.8	5075	35.0	2.0	50.8	0.23	B2
DR16SC-06	20755831	3/8	0.70	17.8	5000	34.5	2.5	63.5	0.33	B2
DR16SC-08	20755835	1/2	0.82	20.9	4500	30.1	3.5	88.9	0.43	B2
DR16SC-10	20961024	5/8	0.95	24.4	4000	27.6	4.0	102.0	0.41	B2
DR16SC-12	20755850	3/4	1.10	28.0	3500	24.1	5.0	127.0	0.61	B2
DR16SC-16	20776987	1	1.42	35.9	3000	20.6	6.0	152.4	0.94	B2

*DR16-04 working pressure does not meet SAE 100R16 or EN 857 2SC requirements.

HOSE



Desert® DR16SC
High Pressure

Compatible Fittings

All fittings compatible with Desert® DR16SC are listed in Section 1 (starting on page 131).

Desert® DR5

Desert® DR5 is a high-temperature, medium-pressure hose for use in applications including turbocharger oil lines, tilt cab cylinder and air brake lines, transmission coolant and filtration lines. It is compatible with petroleum oil and phosphate ester-based hydraulic fluids, air, water, diesel fuel, petroleum-based lubricating oils and coolants.



PERFORMANCE + SPECS

Meets or exceeds the performance requirements of:

SAE 100R5
DOT FMVSS 106 Type All
SAE J1402 Type All

Note: Sizes 7/8" (-16) and 1 1/8" (-20) do not meet DOT FMVSS 106 Type All and SAE J1402 Type All because these sizes are not listed in the referenced specifications.

Inner Tube CPE (Chlorinated Polyethylene)

Reinforcement

One braid of textile, one braid of steel

Cover

Blue impregnated textile braid

Temperature Range

SAE 100R5 hydraulic applications:
 -40°F to 302°F (-40°C to 150°C)

Air brake and general air applications:
 -40°F to 200°F (-40°C to 93°C)

General hot oil applications:
 -40°F to 302°F (-40°C to 150°C)

Water applications:
 -40°F to 212°F (-40°C to 100°C)

KEY FEATURES



Handles high temperature



4:1 Safety Factor



SAE J1942/
 U.S. Coast Guard

Requires GTEX protective sleeving.

BRANDING



DR5-10

SAE 100R5 / DOT FMVSS 106 All
 J1402 AIR BRAKE

1/2" (12.7 MM)

1750 PSI (12.1 MPa)

MADE
 IN USA

#	SAP	Hose Size ID	Hose OD	Max. Working Pressure	Min. Bend Radius	Weight	Fitting
Part Number	SAP Number	in.	in.	psi	in.	lbs./ft.	
DR5-04	20340705	3/16	0.52	3000	3.0	0.15	UC, FG
DR5-05	20341023	1/4	0.58	3000	3.4	0.18	UC, FG
DR5-06	20340706	5/16	0.68	2250	4.0	0.22	UC, FG
DR5-08	20340707	13/32	0.77	2000	4.5	0.30	UC, FG
DR5-10	20340708	1/2	0.92	1750	5.5	0.37	UC, FG
DR5-12	20341025	5/8	1.08	1500	6.5	0.45	UC, FG
DR5-16	20340709	7/8	1.24	800	7.4	0.47	UC, FG
DR5-20	20368015	1 1/8	1.50	625	9.0	0.58	UC, FG
DR5-24	20918279	1 3/8	1.75	500	10.5	0.79	UC, FG
DR5-32	20919400	1 13/16	2.22	350	13.2	1.20	UC, FG

Not recommended for under-the-hood, automotive and truck fuel line applications. Only hose designed and tested to meet SAE fuel line standards should be used for these applications. *Assemblies made with the Continental DR5 hose and Continental Field-Grip™ or Uni-Crimp™ fittings meet SAE J1402 and DOT FMVSS 571 106 specifications. Assemblies made with Uni-Crimp™ fittings also meet SAE J517 100R5 assembly requirements. Federal law requires registration with the Department of Transportation for anyone producing air brake hose assemblies.

Desert® DR5
 Fleet Application

Compatible Fittings

UC fittings are listed in Section 5* (starting on page 242).
 FG fittings are listed in Section 6* (starting on page 279).

HOSE



Desert® DUT

Desert® DUT is a high-temperature, medium-pressure hose for use in applications including turbocharger oil lines, tilt cab cylinder and air brake lines, transmission coolant and filtration lines. It is compatible with petroleum oil and phosphate ester-based hydraulic fluids, air, water, diesel fuel, petroleum-based lubricating oils and coolants.



PERFORMANCE + SPECS

Meets or exceeds the performance requirements of:

SAE J1402 Type AI

DOT FMVSS 106 Type AI

Note: Sizes 7/8" (-16) and 1 1/8" (-20) do not meet DOT FMVSS 106 Type AI and SAE J1402 Type AI because these sizes are not listed in the referenced specifications.

Inner Tube CPE (Chlorinated Polyethylene)

Reinforcement

One braid of textile, one braid of steel

Cover

Blue impregnated textile braid

Temperature Range

Air brake and general air applications:

-40°F to 200°F (-40°C to 93°C)

General hot oil applications:

-40°F to 302°F (-40°C to 150°C)

Water applications:

-40°F to 212°F (-40°C to 100°C)

KEY FEATURES



Handles high temperature



4:1 Safety Factor

BRANDING



DUT-10

SAE J1402 TYPE AI AIR BRAKE
DOT FMVSS 106 AI

1/2" (12.7 MM)

1000 PSI (68.9 MPa)

MADE
IN USA

#	SAP	Hose Size ID	Hose OD	Max. Working Pressure	Min. Bend Radius	Weight	Fitting			
Part Number	SAP Number	in.	in.	mm	psi	MPa	in.	mm	lbs./ft.	
DUT-04	20367570	3/16	0.49	12.4	2000	13.8	2.0	51	0.12	UT
DUT-05	20367574	1/4	0.55	14.0	1500	10.3	2.5	64	0.14	UT
DUT-06	20367576	5/16	0.62	15.7	1500	10.3	3.0	76	0.17	UT
DUT-08	20367577	13/32	0.74	18.8	1250	8.6	3.5	89	0.20	UT
DUT-10	20367578	1/2	0.83	21.1	1000	6.9	4.0	102	0.22	UT
DUT-12	20367579	5/8	0.96	24.4	750	5.2	4.5	114	0.24	UT
DUT-16	20424721	7/8	1.21	30.7	400	2.8	5.0	127	0.30	UT
DUT-20	20424722	1 1/8	1.49	37.8	300	2.1	5.5	140	0.44	UT

Not recommended for under-the-hood, automotive and truck fuel line applications. Only hose designed and tested to meet SAE fuel line standards should be used for these applications. Note: Federal law requires registration with the Department of Transportation for anyone producing air brake hose assemblies.

HOSE



Desert® DUT

Truck and Fleet Applications

Compatible Fittings

All fittings compatible Desert® DUT are listed in Section 9 (starting on page 362).

HR6

HR6 is for use during low-pressure, textile reinforced applications that include petroleum and water-based fluids for use in power steering return, lube lines and air lines. HR6 is not intended for brake applications.



PERFORMANCE + SPECS

Meets or exceeds the performance requirements of:

SAE 100R6
EN 854 R6

Inner Tube
NBR (Nitrile)

Reinforcement

One textile braid

Cover

Black CSM (Chlorosulfonated Polyethylene)

Temperature Range

-40°F to 275°F (-40°C to 135°C)

KEY FEATURES



Handles high temperature



4:1 Safety Factor

BRANDING



HR6-08

SAE 100R6 / EN 854 R6
1/2" (DN12)

400 PSI (2.8 MPa)

MADE
IN USA

#	SAP	Hose Size ID	Hose OD		Max. Working Pressure		Min. Bend Radius		Weight	Fitting
Part Number	SAP Number	in.	in.	mm	psi	MPa	in.	mm	lbs./ft.	
HR6-04	20687451	1/4	0.51	12.9	400	2.8	2.5	64	0.09	UC
HR6-05	20788391	5/16	0.57	14.5	400	2.8	3.0	76	0.09	UC
HR6-06	20687409	3/8	0.64	16.2	400	2.8	3.0	76	0.11	UC
HR6-08	20743641	1/2	0.77	19.6	400	2.8	4.0	102	0.16	UC
HR6-10	20616767	5/8	0.91	23.2	350	2.4	5.0	127	0.18	UC
HR6-12	20645813	3/4	1.06	26.9	300	2.1	6.0	152	0.25	UC

HR6

Low Pressure

Compatible Fittings

All fittings compatible with HR6 are listed in Section 5 (starting on page 242).

HOSE





GET RELIABLE PERFORMANCE DOWN COLD

Arctic LOW TEMPERATURE

	Page	Construction	Inner Tube	Working Pressure (psi)	Temperature Range	Fitting Series	Approvals	Packaging
ARCTIC® LR2SN	55	Wire braid	Nitrile	1160-5000	-70°F to 212°F	B2	MSHA, SAE 100R2AT, EN 853	04-16: 250' Reel 24-32: 50', 100' or 200' Coil
ARCTIC® LR16SC	56	Wire braid	Nitrile	3000-5800	-70°F to 212°F	B2	MSHA, SAE 100R16, EN 857 2SC	250' Reel

HOSE

Continental

Arctic LOW TEMPERATURE

Arctic® LR2SN

Arctic® LR2SN is for high-pressure hydraulic oil lines used in construction, machine tool and agricultural applications where lower temperature petroleum- or water-based hydraulic fluids are a factor.



PERFORMANCE + SPECS

Meets or exceeds the performance requirements of:

SAE 100R2AT
EN 853 2SN

Meets flame resistance
USMSHA Designation

Meets higher
EN/DIN Pressures

Inner Tube

NBR (Nitrile)

Reinforcement

Two braids of high-tensile steel wire

Cover

Black CR (Polychloroprene)

Temperature Range

-70°F to 212°F (-57°C to 100°C)

KEY FEATURES



Handles low temperature



4:1 Safety Factor

BRANDING



ARCTIC® LR2SN-08

SAE 100R2AT / 2SN
Low Temperature

1/2"
(DN12)

4000 PSI

27.6 MPa
275.7 BAR

MSHA 2G-1C-14C/41

MADE
IN USA

#	SAP	Hose Size ID	Hose OD	Max. Working Pressure	Min. Bend Radius	Weight	Fitting			
Part Number	SAP Number	in.	in.	mm	psi	MPa	in.	mm	lbs./ft.	
LR2AT-04*	20239365	1/4	0.58	14.7	5000	34.5	4.0	102	0.24	B2
LR2SN-06	20728489	3/8	0.74	18.7	4800	33.1	5.0	127	0.34	B2
LR2SN-08	20728510	1/2	0.86	21.8	4000	27.6	7.0	178	0.43	B2
LR2SN-10	20728511	5/8	0.99	25.0	3630	25.0	8.0	203	0.50	B2
LR2SN-12	20728512	3/4	1.14	29.0	3120	21.5	9.5	241	0.61	B2
LR2SN-16	20728513	1	1.48	37.6	2400	16.5	12.0	305	0.88	B2
LR2SN-20	20757165	1 ¼	1.88	47.7	1820	12.5	16.5	419	1.52	B2
LR2SN-24	20757167	1 ½	2.13	54.1	1310	9.0	20.0	508	1.64	B2
LR2SN-32	20757168	2	2.63	66.7	1160	8.0	25.0	635	2.02	B2

*LR2AT-04 working pressure does not meet EN 853 requirements.

Arctic® LR2SN
High Pressure

Compatible Fittings

All fittings compatible with Arctic® LR2SN are listed in Section 1 (starting on page 131).

HOSE



Arctic® LR16SC

Arctic® LR16SC is made for high-pressure service with tight bends for petroleum and water-based hydraulic fluids. It has excellent impulse performance and flexibility exceeding SAE 100R2 and SAE 100R16 standards.



PERFORMANCE + SPECS

Meets or exceeds the performance requirements of:

SAE 100R16
EN 857 2SC

Meets flame resistance
USMSHA Designation

Meets higher
EN/DIN Pressures

Inner Tube

Black nitrile synthetic rubber

Reinforcement

One braid of steel wire

Cover

Black CR (Polychloroprene)

Temperature Range

-70°F to 212°F (-57°C to 100°C)

KEY FEATURES



Handles low temperature



Made for tight bends



4:1 Safety Factor

BRANDING



ARCTIC® LR16SC-08

SAE 100R16 / EN 857 2SC
1/2" (DN12)

4500 PSI 34.5 MPa
345 BAR

MSHA 2G-1C-14C/41

MADE
IN USA



Part Number



SAP Number



Hose Size ID



Hose OD



Max. Working Pressure



Min. Bend Radius



Weight



Fitting

Part Number	SAP Number	Hose Size ID		Hose OD		Max. Working Pressure		Min. Bend Radius		Weight	Fitting
		in.	in.	mm	psi	MPa	in.	mm	lbs./ft.		
LR16SC-04	20977183	1/4	0.56	14.2	5800	40.0	2.0	51	0.28	B2	
LR16SC-06	20977189	3/8	0.72	18.3	5000	34.5	2.5	64	0.33	B2	
LR16SC-08	20901038	1/2	0.85	21.5	4500	31.0	3.5	89	0.38	B2	
LR16SC-10	21008859	5/8	0.97	24.7	4000	27.6	4.0	102	0.46	B2	
LR16SC-12	21009100	3/4	1.13	28.6	3500	24.1	5.0	127	0.59	B2	
LR16SC-16	21009108	1	1.44	36.6	3000	20.7	6.0	152	1.06	B2	

HOSE



Arctic® LR16SC
High Pressure

Compatible Fittings

All fittings compatible with Arctic® LR16SC are listed in Section 1 (starting on page 131).

CLASSICS

	Page	Construction	Inner Tube	Working Pressure (psi)	Temperature Range	Fitting Series	Approvals	Packaging
SR1SN	58	Wire braid	Nitrile	580 - 3630	-40°F to 212°F	UC, B2	MSHA, SAR 100R1AT, EN 853 1SN, USCG	03-20: 250' Reel; 50' Box 24-32: 100' or 200' Coil
SR2SN	59	Wire braid	Nitrile	1160 - 6000	-40°F to 212°F	UC, B2	MSHA, SAE 100R2AT, EN 853 2SN, USCG	03-16: 250' Reel; 50' Box 20-32: 100' or 200' Coil
SR16SC	60	Wire braid	Nitrile	1813 - 5800	-40°F to 212°F	B2	MSHA, SAE 100R16, EN 857 2SC, USCG	04-16: 250' Reel; 50' Box; Bulk Carton 20: 200' Coil
SCP3	61	Wire braid	Nitrile	3045	-40°F to 212°F	B2	MSHA, SAE 100R17, USCG	250' Reel; 50' Box; Bulk Carton
SR3	62	Wire braid	Polychloroprene	565 - 1250	-40°F to 212°F	UC	MSHA, SAE 100R3, EN 854 R3	500' Reel; 50' Box
SR5	63	Wire braid	Nitrile	625 - 3000	-40°F to 212°F	UC, FG	SAE 100R5, SAE J1402, DOT FMVSS 106	250' Reel; 50' Box
SR6	64	Wire braid	Nitrile	300 - 500	-40°F to 212°F	UC	SAE 100R6, EN 854 R6	500' Reel; 50' Box
SR12	65	Spiral	Polychloroprene	2250 - 4100	-40°F to 250°F	SG, B2	MSHA, SAE 100R12, EN 856 R13, USCG	50', 100' or 200' Coil
SR13	66	Spiral	Polychloroprene	5100	-40°F to 250°F	SG, DG, S6	MSHA, SAE 100R13, EN 856 R13, USCG	50', 100' or 200' Coil
SR15	67	Spiral	Polychloroprene	6100	-40°F to 250°F	SG, DG	MSHA, SAE 100R5	50', 100' or 200' Coil
S4SH	68	Spiral	Nitrile	3650 - 6090	-40°F to 212°F	SG	MSHA, EN 856 4SH, DIN 20023 4SH	100' or 200' Coil
S4SP	69	Spiral	Nitrile	4640 - 6455	-40°F to 212°F	SG	MSHA, EN 856 4SP, DIN 20023 4SP	100' or 200' Coil

CLASSICS

SR1SN

SR1SN is made for medium-pressure hydraulic applications including mobile, machine tool and agricultural applications, using petroleum or water-based hydraulic fluids.

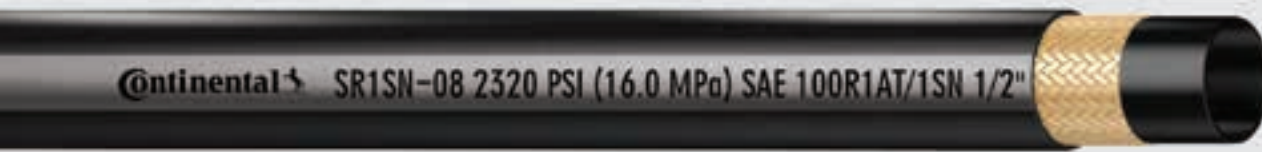

PERFORMANCE + SPECS

Meets or exceeds the performance requirements of:

SAE 100R1AT
EN 853 1SN

Meets flame resistance
USMSHA Designation

Meets higher **EN/DIN Pressures**

Inner Tube NBR (Nitrile)

Reinforcement
One braid of high-tensile steel wire

Cover
Black CR (Polychloroprene)

Temperature Range
-40°F to 212°F (-40°C to 100°C)

KEY FEATURES

 **SAE J1942/**
U.S. Coast Guard

 **4:1 Safety Factor**

BRANDING



SR1SN-08

SAE 100R1AT / 1SN
1/2" (DN12)

2320 PSI (16 MPa)

MSHA 2G-14C/12

MADE
IN USA

#	SAP	Hose Size ID	Hose OD	Max. Working Pressure	Min. Bend Radius	Weight	Fitting
Part Number	SAP Number	in.	in.	psi	in.	lbs./ft.	
SR1SN-03	20239993	3/16	0.47	3630	3.5	0.12	UC
SR1SN-04	20240216	1/4	0.53	3270	4.0	0.15	B2
SR1SN-05	20240217	5/16	0.60	3120	4.5	0.17	B2
SR1SN-06	20240218	3/8	0.69	2615	5.0	0.22	B2
SR1SN-08	20240219	1/2	0.81	2320	7.0	0.28	B2
SR1SN-10	20240250	5/8	0.94	1890	8.0	0.33	B2
SR1SN-12	20240251	3/4	1.10	1530	9.5	0.41	B2
SR1SN-16	20240252	1	1.41	1280	12.0	0.62	B2
SR1SN-20	20708462	1 ¼	1.70	920	16.5	0.84	B2
SR1SN-24	20706727	1 ½	1.98	730	20.0	1.05	B2
SR1SN-32	20706728	2	2.51	580	25.0	1.48	B2

HOSE



SR1SN

Medium Pressure

Compatible Fittings

UC fittings are listed in Section 5 (starting on page 242).
B2 fittings are listed in Section 1 (starting on page 131).

SR2SN

SR2SN is for high-pressure hydraulic oil lines used in construction, machine tool and agricultural applications using petroleum- or water-based hydraulic fluids. This hose features a vacuum rating of 28 in Hg (sizes 3/16"-5/8") or 24 in Hg (sizes 3/4"-1").

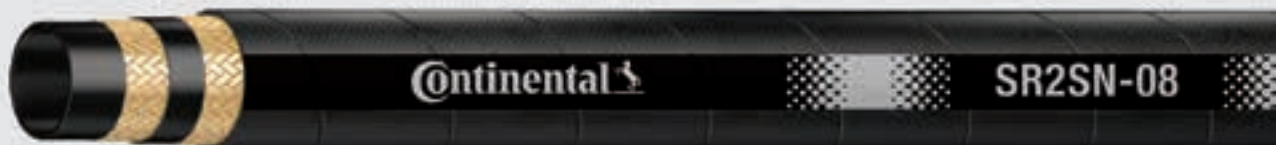

PERFORMANCE + SPECS

Meets or exceeds the performance requirements of:

SAE 100R2AT
EN 853 2SN

Meets flame resistance
USMSHA Designation

Meets higher
EN/DIN Pressures

ABS Type Approved 1/4" through 1"

Inner Tube
NBR (Nitrile)

Reinforcement
Two braids of high-tensile steel wire

Cover
Black CR (Polychloroprene)

Temperature Range
-40°F to 212°F (-40°C to 100°C)

KEY FEATURES

 **SAE J1942/**
U.S. Coast Guard

 **4:1** 4:1 Safety Factor

BRANDING

 **SR2SN-08** SAE 100R2AT / 2SN 1/2" (DN12) **4000 PSI** 27.6 MPa 275.7 BAR **MSHA 2G-14C/12** **MADE IN USA**

#	SAP	Hose Size ID	Hose OD	Max. Working Pressure	Min. Bend Radius	Weight	Fitting			
Part Number	SAP Number	in.	in.	mm	psi	MPa	in.	mm	lbs./ft.	
SR2SN-03	20240253	3/16	0.48	12.3	6000	41.3	3.5	89	0.20	UC
SR2SN-04	20240254	1/4	0.59	15.1	5800	40.0	4.0	102	0.24	B2
SR2SN-06	20276604	3/8	0.75	19.1	4800	33.1	5.0	127	0.34	B2
SR2SN-08	20270619	1/2	0.88	22.2	4000	27.6	7.0	178	0.43	B2
SR2SN-10	20240257	5/8	1.00	25.4	3630	25.0	8.0	203	0.50	B2
SR2SN-12	20240258	3/4	1.16	29.4	3120	21.5	9.5	241	0.61	B2
SR2SN-16	20240259	1	1.50	38.1	2400	16.5	12.0	305	0.88	B2
SR2SN-20	20239362	1 ¼	1.86	47.2	1820	12.5	16.5	419	1.53	B2
SR2SN-24	20239363	1 ½	2.11	54.1	1310	9.0	20.0	508	1.64	B2
SR2SN-32	20239364	2	2.62	66.7	1160	8.0	25.0	635	2.02	B2

SR2SN
High Pressure

Compatible Fittings
UC fittings are listed in Section 5 (starting on page 242).
B2 fittings are listed in Section 1 (starting on page 131).



SR16SC

SR16SC is made for high-pressure service with tight bends using petroleum- and water-based hydraulic fluids. It has excellent impulse performance and flexibility exceeding SAE 100R2 and SAE 100R16 standards.



PERFORMANCE + SPECS

Meets or exceeds the performance requirements of:

SAE 100R16
EN 857 2SC

Meets flame resistance
USMSHA Designation

Meets higher
EN/DIN Pressures

Inner Tube
NBR (Nitrile)

Reinforcement
Two braids of high-tensile steel wire

Cover
Black CR (Polychloroprene)

Temperature Range
-40°F to 212°F (-40°C to 100°C)

KEY FEATURES



Made for
tight bends



SAE J1942/
U.S. Coast Guard



4:1 Safety Factor

BRANDING



SR16SC-08

SAE 100R16 / EN 857 2SC
1/2" (DN12)

5000 PSI (34.5 MPa)

MSHA 2G-1C-14C/37

MADE
IN USA



Part Number



SAP Number



Hose Size ID



Hose OD



Max. Working Pressure



Min. Bend Radius



Weight



Fitting

Part Number	SAP Number	Hose Size ID		Hose OD		Max. Working Pressure		Min. Bend Radius		Weight	Fitting
		in.	in.	mm	psi	MPa	in.	mm	lbs./ft.		
SR16SC-04	20494340	1/4	0.54	13.7	5800	40.0	2.0	51	0.18	B2	
SR16SC-06	20436685	3/8	0.70	17.7	5000	34.5	2.5	64	0.27	B2	
SR16SC-08	20263798	1/2	0.81	20.6	5000	34.5	3.5	89	0.36	B2	
SR16SC-10	20264959	5/8	0.95	24.2	4350	30.0	4.0	102	0.41	B2	
SR16SC-12	20527916	3/4	1.10	28.0	3500	24.1	5.0	127	0.55	B2	
SR16SC-16	20483278	1	1.40	35.5	3000	20.6	6.0	152	0.83	B2	
SR16SC-20	20666436	1 1/4	1.74	44.3	1813	12.5	8.3	210	1.12	B2	

HOSE



SR16SC

High Pressure

Compatible Fittings

All fittings compatible with SR16SC are listed in Section 1 (starting on page 131).

SCP3

SCP3 is made for high-pressure hydraulic applications designed to replace SAE 100R17 where higher pressures and a more flexible hose are required.



PERFORMANCE + SPECS

Meets or exceeds the performance requirements of:

SAE 100R17

Meets flame resistance

USMSHA Designation

Inner Tube

NBR (Nitrile)

Reinforcement

One braid of high-tensile steel wire (sizes 1/4", 3/8" and 1/2")

Two-wire braid of high-tensile steel wire (sizes 5/8", 3/4" and 1")

Cover

Black CR (Polychloroprene)

Temperature Range









-40°F to 212°F (-40°C to 100°C)

KEY FEATURES

-  Handles constant pressure
-  SAE J1942/ U.S. Coast Guard
-  4:1 Safety Factor

BRANDING

 **SCP3-04** SAE 100R17 1/4" (6.4 MM) 3045 PSI 20.7 MPa **MSHA 2G-1C-14C/12** MADE IN USA

										
Part Number	SAP Number	Hose Size ID	Hose OD	Max. Working Pressure	Min. Bend Radius	Weight	Fitting			
		in.	in.	mm	psi	MPa	in.	mm	lbs./ft.	
SCP3-04	20318573	1/4	0.50	12.7	3045	21	2.0	51	0.11	B2
SCP3-06	20317756	3/8	0.65	16.5	3045	21	2.5	64	0.17	B2
SCP3-08	20318576	1/2	0.78	19.8	3045	21	3.5	89	0.28	B2
SCP3-10	20608301	5/8	0.95	24.1	3045	21	4.0	102	0.41	B2
SCP3-12	20470795	3/4	1.13	28.7	3045	21	5.0	127	0.55	B2
SCP3-16	20329003	1	1.44	36.6	3045	21	6.0	152	0.82	B2

SCP3

Constant Pressure / High Pressure

Compatible Fittings

All fittings compatible with SCP3 are listed in Section 1 (starting on page 131).

HOSE



SR3

SR3 is a low-pressure, textile reinforced hose for petroleum- or water-based hydraulic fluids or pneumatic applications. It is not to be used for air brake.



PERFORMANCE + SPECS

Meets or exceeds the performance requirements of:

SAE 100R3

EN 854 R3

Meets flame resistance

USMSHA Designation

Inner Tube

CR (Polychloroprene)

Reinforcement

Two textile braids

Cover

Black CR (Polychloroprene)

Temperature Range

-40°F to 212°F (-40°C to 100°C)

KEY FEATURES

4:1 4:1 Safety Factor

BRANDING



SR3-08

SAE 100R3 / EN 854 R3
1/2" (DN12)

1000 PSI (6.9 MPa)

MSHA 2G-1C-14C/30

#	SAP	Hose Size ID	Hose OD		Max. Working Pressure		Min. Bend Radius		Weight	Fitting
Part Number	SAP Number	in.	in.	mm	psi	MPa	in.	mm	lbs./ft.	
SR3-04	20240260	1/4	0.56	14.3	1250	8.6	3.0	76	0.12	UC
SR3-05	20239389	5/16	0.68	17.5	1200	8.3	4.0	102	0.16	UC
SR3-06	20240261	3/8	0.75	19.1	1125	7.8	4.0	102	0.17	UC
SR3-08	20240262	1/2	0.94	23.8	1000	6.9	5.0	127	0.25	UC
SR3-10	20553192	5/8	1.06	27.1	884	6.1	5.5	140	0.31	UC
SR3-12	20240275	3/4	1.25	31.8	750	5.2	6.0	152	0.43	UC
SR3-16	20240276	1	1.50	38.1	565	3.9	8.0	203	0.51	UC

HOSE



SR3

Low Pressure

Compatible Fittings

All fittings compatible with SR3 are listed in Section 5 (starting on page 242).

SR5

SR5 is a general-purpose, medium-pressure hose for air brakes, power steering, turbo oil lines, tilt cab cylinders, transmission coolant and filtration lines. This hose is compatible with petroleum- based hydraulic fluids, air, water, gasoline and diesel fuel, lubricating oils and coolants.



PERFORMANCE + SPECS

Meets or exceeds the performance requirements of:

- SAE 100R5**
- DOT FMVSS 106 Type All**
- SAE J1402 Type All**

Note: Sizes 7/8", 1 1/8", 1 3/8" and 1 1/2" do not meet DOT FM VSS 106 Type All and SAE J1402 Type All because these sizes are not listed in the referenced specifications.

Inner Tube

NBR (Nitrile)

Reinforcement

One braid of high-tensile steel wire



Cover

Black impregnated textile braid

Temperature Range

-40°F to 212°F (-40°C to 100°C)

KEY FEATURES

-  **4:1 Safety Factor**
-  **SAE J1942/
U.S. Coast Guard**
Requires GTEX protective sleeving.

BRANDING



SR5-08

SAE 100R5 / DOT FMVSS 106 All
J1402 AIR BRAKE

2000 PSI (13.8 MPa)

MADE
IN USA

#	SAP	Hose Size ID	Hose OD	Max. Working Pressure	Min. Bend Radius	Weight	Fitting			
Part Number	SAP Number	in.	in.	mm	psi	MPa	in.	mm	lbs./ft.	
SR5-04	20324155	3/16	0.52	13.2	3000	20.7	3.0	76	0.15	UC, FG
SR5-05	20416026	1/4	0.58	14.8	3000	20.7	3.4	86	0.18	UC, FG
SR5-06	20324042	5/16	0.68	17.1	2250	15.5	4.0	102	0.22	UC, FG
SR5-08	20324041	13/32	0.77	19.5	2000	13.8	4.6	117	0.30	UC, FG
SR5-10	20326081	1/2	0.92	23.4	1750	12.1	5.5	140	0.37	UC, FG
SR5-12	20455110	5/8	1.08	27.4	1500	10.3	6.5	165	0.45	UC, FG
SR5-16	20340597	7/8	1.24	31.4	800	5.5	7.4	187	0.47	UC, FG
SR5-20	20436687	1 1/8	1.50	38.1	625	4.3	9.0	229	0.58	UC, FG

Not recommended for under-the-hood, automotive and truck fuel line applications. Only hose designed and tested to meet SAE fuel line standards should be used for these applications. *Assemblies made with the Continental SR5 hose and Continental Field-Grip™ or Uni-Crimp™ fittings meet SAE J1402 and DOT FMVSS 571 106 specifications. Assemblies made with Uni-Crimp™ fittings also meet SAE J517 100R5 assembly requirements. Federal law requires registration with the Department of Transportation for anyone producing air brake hose assemblies.

SR5

Fleet Application

Compatible Fittings

UC fittings are listed in Section 5* (starting on page 242).
FG fittings are listed in Section 6* (starting on page 279).

HOSE



SR6

SR6 is made for use during low-pressure, textile reinforced applications that include petroleum and water-based fluids for use as power steering return, lube lines and air lines. This hose is not intended for brake applications.



PERFORMANCE + SPECS

Meets or exceeds the performance requirements of:

SAE 100R6
EN 854 R6

Inner Tube
NBR (Nitrile)

Reinforcement
One textile braid

Cover
Black CR (Polychloroprene)

Temperature Range
-40°F to 212°F (-40°C to 100°C)

KEY FEATURES

4:1 4:1 Safety Factor

BRANDING

 **SR6-08** SAE 100R6 / EN 854 R6 1/2" (DN12) **400 PSI (2.8 MPa)**

#	SAP	Hose Size ID	Hose OD		Max. Working Pressure		Min. Bend Radius		Weight	Fitting
Part Number	SAP Number	in.	in.	mm	psi	MPa	in.	mm	lbs./ft.	
SR6-03	20240277	3/16	0.44	11.1	500	3.4	2.0	51	0.07	UC
SR6-04	20240278	1/4	0.50	12.7	400	2.8	2.5	64	0.09	UC
SR6-05	20240279	5/16	0.56	9.1	400	2.8	3.0	76	0.09	UC
SR6-06	20240280	3/8	0.63	15.9	400	2.8	3.0	76	0.11	UC
SR6-08	20240281	1/2	0.78	19.8	400	2.8	4.0	102	0.16	UC
SR6-10	20240282	5/8	0.91	23.0	350	2.4	5.0	127	0.18	UC
SR6-12	20254775	3/4	1.05	26.6	300	2.1	6.0	152	0.25	UC

HOSE



SR6

Low Pressure

Compatible Fittings

All fittings compatible with SR6 are listed in Section 5 (starting on page 242).

SR12

SR12 is made for very high-pressure applications subject to surges or flexing such as oil and gas, construction equipment, mining and the high-performance industrial market.



PERFORMANCE + SPECS

Meets or exceeds the performance requirements of:

SAE 100R12
EN 856 R12

Meets flame resistance
USMSHA Designation

ABS Type (Pending)

Inner Tube
CR (Polychloroprene)

Reinforcement
Four alternating layers of spiraled high-tensile steel wire

Cover
Black CR (Polychloroprene)

Temperature Range
-40°F to 250°F (-40°C to 121°C)

KEY FEATURES









 **SAE J1942/**
U.S. Coast Guard

 **1/2 Bend (3/8" - 3/4")**

 **4:1** **4:1 Safety Factor**

BRANDING

 **SR12-08** **SAE 100R12 / EN 856** **4100 PSI** **28 MPa** **MSHA 2G-1C-14C/44**
1/2" (DN12) **280 BAR**

 Part Number	 SAP Number	 Hose Size ID	 Hose OD		 Max. Working Pressure		 Min. Bend Radius		 Weight	 Fitting
		in.	in.	mm	psi	MPa	in.	mm	lbs./ft.	
SR12-06	20703115	3/8	0.80	20.3	4100	28.0	2.5	65	0.40	SG
SR12-08	20703046	1/2	0.94	23.8	4100	28.0	3.5	90	0.52	SG
SR12-10	20703117	5/8	1.08	27.4	4100	28.0	4.0	100	0.70	SG
SR12-12	20703048	3/4	1.21	30.7	4100	28.0	4.7	120	0.81	SG
SR12-16	20693294	1	1.50	38.0	4100	28.0	11.8	300	1.20	SG
SR12-20	20703118	1 ¼	1.85	47.0	3050	21.0	16.5	420	1.70	SG, B2
SR12-24	20703119	1 ½	2.10	53.5	2550	17.5	19.7	500	2.05	B2
SR12-32	20693298	2	2.60	66.7	2550	17.5	25.0	635	2.82	B2

SR12

Very High Pressure

Compatible Fittings

B2 fittings are listed in Section 1 (starting on page 131).
SG fittings are listed in Section 2 (starting on page 179).

HOSE



SR13

SR13 is made for very high-pressure applications subject to surges or flexing such as construction equipment, mining and the high-performance industrial market.

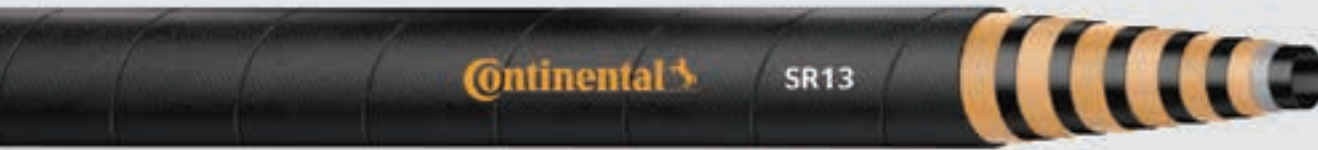

PERFORMANCE + SPECS

Meets or exceeds the performance requirements of:

SAE 100R13
EN 856 R13

Meets flame resistance
USMSHA Designation

ABS Type (Pending)

Inner Tube
CR (Polychloroprene)

Reinforcement

Four alternating layers of spiraled high-tensile steel wire (sizes 1¼", 1½" and 2" have six alternating layers)

Cover

Black CR (Polychloroprene)

Temperature Range

-40°F to 250°F (-40°C to 121°C)

KEY FEATURES

 SAE J1942/
U.S. Coast Guard

 4:1 Safety Factor

BRANDING

 **SR13-12** SAE 100R13 / EN 856 3/4" (DN19) **5100 PSI** 35.0 MPa 350 BAR **MSHA 2G-14C/44**

#	SAP	Hose Size ID	Hose OD		Max. Working Pressure		Min. Bend Radius		Weight	Fitting
Part Number	SAP Number	in.	in.	mm	psi	MPa	in.	mm	lbs./ft.	
SR13-12	20704441	3/4	1.26	32.1	5100	35.0	9.4	240	1.09	SG
SR13-16	20704442	1	1.52	38.7	5100	35.0	11.8	300	1.42	SG
SR13-20	20704443	1 ¼	1.96	49.8	5100	35.0	16.5	420	2.69	SG
SR13-24	20704444	1 ½	2.25	57.3	5100	35.0	19.7	500	3.35	DG, S6
SR13-32	20704450	2	2.80	71.1	5100	35.0	25.2	640	4.93	DG, S6

HOSE



SR13

Very High Pressure

Compatible Fittings

SG fittings are listed in Section 2 (starting on page 179).
S6 and DG fittings are listed in Section 3 (page 216).

SR15

SR15 is designed specifically to handle severe-high-pressure applications where pressure spikes or constant hydrostatic loads are present.



PERFORMANCE + SPECS

Meets or exceeds the performance requirements of:

SAE 100R15

Meets flame resistance

USMSHA Designation

ABS Type (Pending)

Inner Tube CR (Polychloroprene)

Reinforcement

Four alternating layers of spiraled high-tensile steel wire (sizes 1/2", 5/8", 3/4" and 1")

Six alternating layers of high-tensile steel wire (sizes 1/4" and 1/2")

Cover

Black CR (Polychloroprene)

Temperature Range

-40°F to 250°F (-40°C to 121°C)

KEY FEATURES

4:1 4:1 Safety Factor

BRANDING



SR15-08

SAE 100R15 / EN 856
1/2" (DN12)

6100 PSI 42 MPa
420 BAR

MSHA 2G-1C-14C/44

#	SAP	Hose Size ID	Hose OD	Max. Working Pressure	Min. Bend Radius	Weight	Fitting			
Part Number	SAP Number	in.	in.	mm	psi	MPa	in.	mm	lbs./ft.	
SR15-08	20714798	1/2	0.95	24.2	6100	42.0	7.9	200	0.59	N/A
SR15-12	20714785	3/4	1.26	32.0	6100	42.0	10.4	265	1.09	SG
SR15-16	20714793	1	1.53	38.8	6100	42.0	13.0	330	1.46	SG
SR15-20	20714794	1 1/4	1.89	48.0	6100	42.0	17.5	445	2.41	SG
SR15-24	20714795	1 1/2	2.23	56.8	6100	42.0	20.9	530	3.02	DG

SR15

Very High Pressure

Compatible Fittings

SG fittings are listed in Section 2 (starting on page 179).
DG fittings are listed in Section 3 (starting on page 216).

HOSE



S4SH

S4SH is designed for very high-pressure, pulsating applications where petroleum-based hydraulic fluids are used.



PERFORMANCE + SPECS

Meets or exceeds the performance requirements of:

EN 856 4SH
DIN 20023 4SH

Meets flame resistance
USMSHA Designation

ABS Type (Pending)

Inner Tube NBR (Nitrile)

Reinforcement
Four alternating layers of spiraled high-tensile steel wire

Cover
Black CR (Polychloroprene)

Temperature Range
-40°F to 212°F (-40°C to 100°C)

KEY FEATURES

4:1 4:1 Safety Factor

BRANDING

S4SH-12 **EN 856 4SH 3/4" (DN19)** **6090 PSI (42 MPa)** **MSHA 2G-1C-14C/44**

#	SAP	Hose Size ID	Hose OD		Max. Working Pressure		Min. Bend Radius		Weight	Fitting
Part Number	SAP Number	in.	in.	mm	psi	MPa	in.	mm	lbs./ft.	
S4SH-12	20706576	3/4	1.27	32.2	6090	42.0	11.0	280	1.09	SG
S4SH-16	20706577	1	1.52	38.7	5510	38.0	13.4	340	1.42	SG
S4SH-20	20706723	1 ¼	1.79	45.5	5080	35.0	17.9	455	1.71	SG
S4SH-24	20706724	1 ½	2.11	53.5	4205	29.0	22.0	560	2.19	SG
S4SH-32	20706725	2	2.68	68.1	3650	25.0	28.0	710	3.31	SG

HOSE

S4SH

Very High Pressure

Compatible Fittings

All fittings compatible with S4SH are listed in Section 2 (starting on page 179).

S4SP

S4SP is made for very high-pressure applications used for petroleum-based hydraulic fluids.



PERFORMANCE + SPECS

Meets or exceeds the performance requirements of:

EN 856 4SP
DIN 20023 4SP

Meets flame resistance
USMSHA Designation

ABS Type (Pending)

Inner Tube

NBR (Nitrile)

Reinforcement

Four alternating layers of spiraled high-tensile steel wire

Cover

Black CR (Polychloroprene)

Temperature Range

-40°F to 212°F (-40°C to 100°C)

KEY FEATURES

4:1 4:1 Safety Factor

BRANDING



S4SP-08

EN 856 4SP
1/2" (DN12)

6020 PSI (41.5 MPa)

MSHA 2G-1C-14C/44

#	SAP	Hose Size ID	Hose OD	Max. Working Pressure	Min. Bend Radius	Weight	Fitting			
Part Number	SAP Number	in.	in.	mm	psi	MPa	in.	mm	lbs./ft.	
S4SP-06	20714777	3/8	0.84	21.4	6455	45.0	7.1	180	0.51	SG
S4SP-08	20714778	1/2	0.97	24.6	6020	41.5	9.0	230	0.58	SG
S4SP-10	20714779	5/8	1.11	28.2	5075	35.0	9.8	250	0.73	SG
S4SP-12	20714771	3/4	1.27	32.2	5510	38.0	11.8	300	0.98	SG
S4SP-16	20714773	1	1.56	39.7	4640	32.0	13.4	340	1.30	SG

S4SP

Very High Pressure

Compatible Fittings

All fittings compatible with S4SP are listed in Section 2 (starting on page 179).

HOSE



SPECIAL APPLICATION HOSE

	Page	Construction	Inner Tube	Working Pressure (psi)	Temperature Range	Fitting Series	Approvals	Packaging
SGUN	71	Wire braid	Nitrile	3000	-40°F to 212°F	GG	MSHA	500' Reel
SHJ	72	Wire braid	Polychloroprene	10000	-40°F to 212°F	B2	MSHA	250' Reel
SAFLEX® NSFX	73	Wire braid	Polychloroprene	2000 - 2750	-40°F to 212°F	SF		500' Reel
SR14A	74	Wire braid	Polytetrafluoroethylene	900 - 3000	-40°F to 212°F	UC	SAE 100R14A, FDA 21 CFR 177	25' or 150' Coil
SFS	75	Wire braid	Nitrile	1000 - 2750	-40°F to 212°F	B2	MSHA	250' Reel
PROSPECTOR™ BOP 3000	76	Wire braid	Nitrile	3000	-40°F to 212°F	UC	Llyod's Certified	250' Reel, Bulk Carton
PROSPECTOR™ BOP 5000	77	Spiral	Polychloroprene	5000	-40°F to 212°F	UC, DG	Llyod's Certified	50', 100' or 200' Coil
PROSPECTOR™ HOT OILER	78	Wire braid	Oil-resistant synthetic rubber	2500	-40°F to 212°F	B2	MSHA	100' or 150' Coil

HOSE

SPECIAL APPLICATION HOSE

SGUN

SGUN is designed to be used as a grease whip hose or general purpose lubrication line. It is intended for use with hand grease guns only (not for powered units).

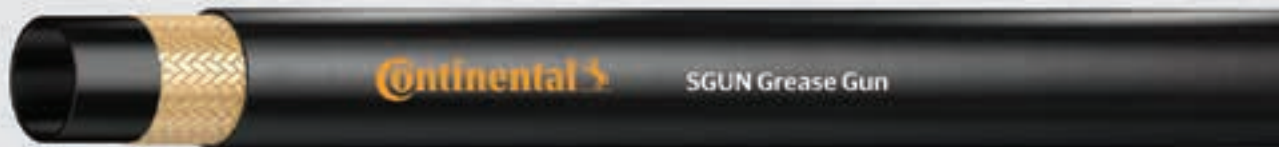

PERFORMANCE + SPECS

Meets flame resistance

USMHA Designation

Inner Tube

NBR (Nitrile)

Reinforcement

One braid of high-tensile steel wire

Cover

Black CR (Polychloroprene)

Temperature Range

-40°F to 212°F (-40°C to 100°C)

KEY FEATURES



Flame-resistant



4:1 Safety Factor

BRANDING



SGUN-03 Grease Gun Hose 3/16" (4.8 MM) 3000 PSI (20.7 MPa) MSHA 2G-14C/12

MADE IN USA

#	SAP	Hose Size ID	Hose OD		Max. Working Pressure		Min. Bend Radius		Weight	Fitting
Part Number	SAP Number	in.	in.	mm	psi	MPa	in.	mm	lbs./ft.	
SGUN-03	20240286	3/16	0.41	10.4	3000	20.7	NA	NA	0.09	GG

SGUN

Special Application

Compatible Fittings

All fittings compatible with SGUN are listed in Section 10 (starting on page 370).

HOSE



SHJ

SHJ is designed for extreme high-pressure hydraulic lines for jacking systems.

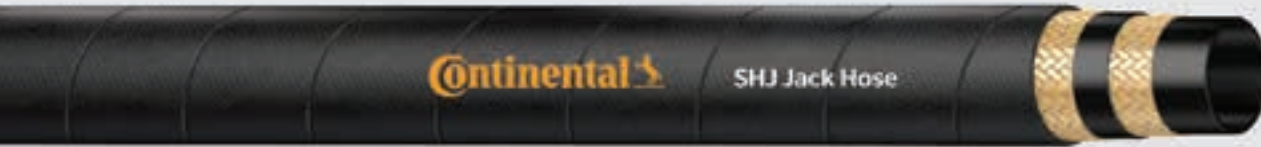

PERFORMANCE + SPECS

Meets flame resistance
USMSHA Designation

Inner Tube
NBR (Nitrile)

Reinforcement
Two braids of high-tensile steel wire

Cover
Black CR (Polychloroprene)

Temperature Range
-40°F to 212°F (-40°C to 100°C)

KEY FEATURES

 Flame-resistant

 2:1 Safety Factor

BRANDING

 **SHJ-04 Jack Hose** 1/4" (6.4 MM) 10000 PSI (68.9 MPa) MSHA 2G-14C/12 MADE IN USA

#	SAP	Hose Size ID	Hose OD		Max. Working Pressure		Min. Bend Radius		Weight	Fitting
Part Number	SAP Number	in.	in.	mm	psi	MPa	in.	mm	lbs./ft.	
SHJ-04	20319601	1/4	0.58	14.7	10000	68.9	4.0	102	0.24	B2
SHJ-06	20319602	3/8	0.74	18.7	10000	68.9	5.0	127	0.30	B2

HOSE

SHJ

Special Application

Compatible Fittings

All fittings compatible with SHJ are listed in Section 1 (starting on page 131).

Saflex® (NSFX)

Saflex® NSFX is designed for medium-pressure applications where shock hazards exist and non-conductivity is required. This hose meets the maximum leakage of 100 microamps/ft. at 75 KV for 3 minutes.



PERFORMANCE + SPECS

Meets maximum leakage of **100 microamps/ft. at 75 KV** for 3 minutes

Inner Tube
CR (Polychloroprene)

Reinforcement
Two textile braids

Cover
Orange NBR/PVC (Nitrile/PVC)









Temperature Range
-40°F to 212°F (-40°C to 100°C)

KEY FEATURES

-  Non-conductive
-  4:1 Safety Factor

BRANDING

 **NSFX-08 Saflex® (Non-Conductive) 1/2" (12.7 MM) 2000 PSI (13.8 MPa)**

 Part Number	 SAP Number	 Hose Size ID	 Hose OD		 Max. Working Pressure		 Min. Bend Radius		 Weight	 Fitting
		in.	in.	mm	psi	MPa	in.	mm	lbs./ft.	
NSFX-04	20240283	1/4	0.56	14.2	2750	19.1	3.5	89	0.11	SF
NSFX-06	20240284	3/8	0.75	19.1	2250	15.5	4.0	102	0.19	SF
NSFX-08	20240285	1/2	0.94	23.7	2000	13.8	6.0	152	0.27	SF

Saflex® (NSFX)
Special Application

Compatible Fittings

All fittings compatible with NSFX are listed in Section 10 (starting on page 370).

HOSE



SR14A

SR14A is designed for medium-pressure hydraulic applications including truck, bus, industrial and aerospace. It is compatible with air, fuel, lubricants, high-temp oil and some chemical applications.



PERFORMANCE + SPECS

Meets or exceeds the performance requirements of:

SAE 100R14A
FDA 21 CFR 177
1500 Specifications

Inner Tube

PTFE (Polytetrafluoroethylene)

Cover / Reinforcement

304 stainless steel wire braid

Temperature Range

Continuous:
-65°F to 450°F (-54°C to 232°C)
Intermittent:
-100°F to 500°F (-73°C to 260°C)

KEY FEATURES











Handles high temperature



Chemical-resistant



4:1 Safety Factor

										
Part Number	SAP Number	Hose Size ID	Hose OD		Max. Working Pressure		Min. Bend Radius		Weight	Fitting
		in.	in.	mm	psi	MPa	in.	mm	lbs./ft.	
SR14A-03	20303683	3/16	0.31	7.9	3000	20.7	2.0	51	0.06	UC
SR14A-04	20303665	1/4	0.38	9.5	3000	20.7	3.0	76	0.08	UC
SR14A-05	20303667	5/16	0.45	11.3	2500	17.2	4.0	102	0.09	UC
SR14A-06	20303669	3/8	0.50	12.8	2250	15.5	4.5	114	0.11	UC
SR14A-08	20303691	1/2	0.65	16.5	1500	10.3	6.5	165	0.15	UC
SR14A-10	20303693	5/8	0.78	19.8	1200	8.3	7.7	196	0.19	UC
SR14A-12	20303695	3/4	0.89	22.5	1100	7.6	8.2	208	0.21	UC
SR14A-16	20303697	1	1.14	28.8	900	6.2	10.0	254	0.32	UC

HOSE

Continental

SR14A

Fleet and Special Application

Compatible Fittings

This hose utilizes UCF9 ferrules with Continental UniCrimp™ stems. For compatible fittings, see Section 5 (starting on page 242).

SFS is made for medium-pressure hydraulic applications including fire suppression actuation equipment where the red cover allows for easy identification.



PERFORMANCE + SPECS

Meets flame resistance
USMSHA Designation

Inner Tube
 NBR (Nitrile)

Reinforcement
 One braid of high-tensile steel wire

Cover
 Red NBR/PVC (Nitrile/PVC)

Temperature Range
 -40°F to 212°F (-40°C to 100°C)

KEY FEATURES

Flame-resistant

4:1 Safety Factor

BRANDING

SFS-08 Fire Suppression Hose **1/2" (DN12)** **2000 PSI 13.8 MPa** **MSHA 2G-1C-14C/31** **MADE IN USA**

Part Number	SAP Number	Hose Size ID	in.	mm	psi	MPa	in.	mm	lbs./ft.	Fitting
SFS-04	20276330	1/4	0.53	13.6	2750	19.1	4	102	0.15	B2
SFS-06	20276331	3/8	0.69	17.5	2250	15.5	5	127	0.22	B2
SFS-08	20276332	1/2	0.81	20.7	2000	13.8	7	178	0.28	B2
SFS-12	20276333	3/4	1.10	27.8	1250	8.6	9.5	241	0.41	B2
SFS-16	20276334	1	1.41	35.8	1000	6.9	12	305	0.62	B2

SFS
 Medium Pressure

Compatible Fittings
 All fittings compatible with SFS are listed in Section 1 (starting on page 131).

Prospector™ BOP 3000

This hose is a hydraulic control connection that is used in the well control system.



PERFORMANCE + SPECS

Inner Tube

NBR (Nitrile)

Reinforcement

Two-wire braided steel

Cover

Pink CR (Polychloroprene), wrapped finish

Temperature Range

-40°F to 212°F (-40°C to 100°C)

Verification

Independently tested per Lloyd's Register Fire Tests for Flexible Hose on Offshore Installations (OD/1000/499-June 29th, 1992) and EUB (Directive 036)

KEY FEATURES



Lloyd's Certified



4:1 Safety Factor

BRANDING



BOP 3000

Meets API 16D
Meets Lloyd's 1000/499 Fire Test

1/2" (12.7 MM)

3000 PSI 20.7 MPa
207 BAR

MADE
IN USA

#	SAP	Hose Size ID	Hose OD		Max. Working Pressure		Min. Bend Radius		Weight	Fitting
Part Number	SAP Number	in.	in.	mm	psi	MPa	in.	mm	lbs./ft.	
BOP-06	20613999	3/8	1.11	28.2	3000	20.7	6.0	152	0.75	UC
BOP-08	20614010	1/2	1.19	30.2	3000	20.7	8.0	203	0.81	UC
BOP-12	20614011	3/4	1.49	37.8	3000	20.7	11.0	279	1.22	UC
BOP-16	20614012	1	1.84	46.7	3000	20.7	15.0	381	1.74	UC

HOSE



Prospector™ BOP 3000

Special Application

Compatible Fittings

Special fitting assembly procedure required.
Contact Continental for more information.

Prospector™ BOP 5000

This hose is a hydraulic control connection that is used in the well control system.

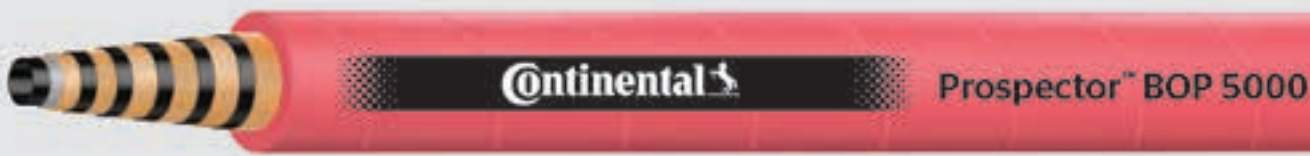

PERFORMANCE + SPECS

Inner Tube

CR (Polychloroprene)

Reinforcement

Four alternating layers of spiraled high-tensile steel wire (sizes 3/8", 1/2", 3/4", 1" and 1¼")

Six alternating layers of spiraled high-tensile steel wire (sizes 1½" and 2")

Cover

Pink CR (Polychloroprene), wrapped finish

Temperature Range

-40°F to 212°F (-40°C to 100°C)

Verification

Tested at Southwest Research Institute and certified by Lloyd's Register to API Specification 16D (Spec 16D, Section 10)

KEY FEATURES



Lloyd's Certified



4:1 Safety Factor

BRANDING



BOP 5000

Meets API 16D
Meets Lloyd's 1000/499 Fire Test

1/2" (12.7 MM)

5000 PSI

34.5 MPa
345 BAR

MADE
IN USA

#	SAP	Hose Size ID	Hose OD	Max. Working Pressure	Min. Bend Radius	Weight	Fitting			
Part Number	SAP Number	in.	in.	mm	psi	MPa	in.	mm	lbs./ft.	
BOP5000-06	20715121	3/8	1.14	29.0	5000	34.5	7.1	180	0.80	UC
BOP5000-08	20715122	1/2	1.24	31.6	5000	34.5	9.0	230	0.90	UC
BOP5000-12	20715123	3/4	1.58	40.1	5000	34.5	11.8	300	1.60	UC
BOP5000-16	20715124	1	1.85	46.9	5000	34.5	13.4	340	2.00	DG
BOP5000-20	20715125	1 ¼	2.10	53.4	5000	34.5	18.1	460	2.40	DG
BOP5000-24	20715126	1 ½	2.59	65.9	5000	34.5	19.7	500	4.10	DG
BOP5000-32	20715127	2	3.14	79.7	5000	34.5	24.8	630	5.50	DG

Prospector™ BOP 5000

Very High Pressure

Compatible Fittings

Special fitting assembly procedure required.
Contact Continental for more information.

HOSE



Prospector™ Hot Oiler

This hose is designed for static-pressure, Hot Oiler applications. It is made specifically to handle the transfer of hot oil at 275°F continuous and 300°F intermittent to clear the paraffin around the casing to help start the flow of oil to the surface.



PERFORMANCE + SPECS

Meets flame resistance
USMSHA Designation

Inner Tube
Oil-resistant synthetic rubber

Reinforcement
Two braids of high-tensile steel wire

Cover
Black oil-resistant synthetic rubber

Temperature Range
-40°F to 275°F (-40°C to 135°C)

KEY FEATURES

~~LIFE™~~ Extended Life™ Cover

Handles high temperature

4:1 Safety Factor

BRANDING

Prospector™ X-Life HOT OILER 1 ½" 2500 PSI **MSHA 2G-1C-14C/45**

Part Number	SAP Number	Hose Size ID	in.	mm	psi	MPa	in.	mm	lbs./ft.	Fitting
Hot Oiler	20830012	1 ½	2.16	54.8	2500	17.2	20.0	508	1.64	B2

HOSE



Prospector™ Hot Oiler
Special Application

Compatible Fittings

All fittings compatible with Prospector™ Hot Oiler are listed in Section 10 (starting on page 370).



MILITARY HOSE

	Page	Construction	Inner Tube	Working Pressure (psi)	Temperature Range	Fitting Series	Approvals	Packaging
MIL-DTL-13444H-I	80	Wire braid	Nitrile	125-425	-65°F to 250°F	UC	MIL-DTL-13444H-I	250' Reel, Bulk Carton
MIL-DTL-13444H-III	81	Wire braid	Nitrile	300 - 1500	-55°F to 300°F	UC	MIL-DTL-13444H-III	250' Reel, Bulk Carton
MIL-DTL-13531	82	Wire braid	Nitrile	2000- 5000	-65°F to 200°F	UC	MIL-DTL-13531	Bulk Carton
MIL-DTL-3992	83	Wire braid	Nitrile	200	-60°F to 200°F	N/A	MIL-DTL-39921	Bulk Carton
MIL-DTL-8788	84	Wire braid	Nitrile	3000	-65°F to 160°F	N/A	MIL-DTL-8788	Bulk Carton



MILITARY HOSE

HOSE

Continental 

MIL-DTL-13444H-I

This hose is designed for fuel and oil lines in military vehicles and other military applications.



PERFORMANCE + SPECS

Meets or exceeds the performance requirements of:

MIL-DTL-13444H Type I

Inner Tube NBR (Nitrile)

Reinforcement
Single-fabric braid

Cover
Black CR (Polychloroprene)

Temperature Range
-65°F to 250°F (-53.89°C to 121.1°C)

Qualification
QPL-13444 Type I approved for bulk hose.

QPL-13444 Type I approved for permanent UC fittings with UCF2 ferrules on factory assemblies. Distributor-made assemblies must seek DSCC approval.

KEY FEATURES

 Military Applications Type I

 4:1 Safety Factor

BRANDING

MIL-H-13444 I 1/2" 2Q18 OZ 63906

#	SAP	Hose Size ID	Hose OD		Max. Working Pressure		Min. Bend Radius		Weight	Fitting
Part Number	SAP Number	in.	in.	mm	psi	MPa	in.	mm	lbs./ft.	
MIL-H-13444-I-3	20472785	3/16	0.44	11.1	425	2.9	2.00	50.80	0.07	UC
MIL-H-13444-I-4	20468052	1/4	0.50	12.7	300	2.0	2.25	57.15	0.09	UC
MIL-H-13444-I-5	20470472	5/16	0.56	14.3	275	1.9	2.75	69.85	0.10	UC
MIL-H-13444-I-6	20472786	3/8	0.63	15.9	250	1.7	3.00	76.20	0.11	UC
MIL-H-13444-I-8	20485914	1/2	0.78	19.8	200	1.4	3.75	95.25	0.17	UC
MIL-H-13444-I-10	20490906	5/8	0.97	25.6	175	1.2	4.75	120.7	0.22	UC
MIL-H-13444-I-12	20493008	3/4	1.09	27.8	125	0.9	5.50	139.7	0.26	UC

HOSE

Continental

MIL-DTL-13444H-I
Military Applications

Compatible Fittings

This hose utilizes UCF2 ferrules with UniCrimp™ stems. For compatible fittings, see Section 5 (starting on page 242).

MIL-DTL-13444H-III

This hose is designed for medium-pressure hydraulic oil and fuel lines. It is intended for use in military vehicles and other support equipment.



PERFORMANCE + SPECS

Meets or exceeds the performance requirements of:

MIL-DTL-13444H Type III

Inner Tube NBR (Nitrile)

Reinforcement

Textile braid and one-wire steel braid

Cover

Black impregnated textile braid

Temperature Range

-55°F to 300°F (-48.33°C to 148.89°C)

Qualification

QPL-13444 Type III approved for bulk hose.

QPL-13444 Type III approved for permanent UC fittings with UCF6 ferrules on factory assemblies. Distributor-made assemblies must seek DSCC approval.

KEY FEATURES











Military Applications Type III



4:1 Safety Factor

BRANDING

MIL-H-13444 III 1/2" 2Q18 63906

										
Part Number	SAP Number	Hose Size ID	Hose OD	Hose OD	Max. Working Pressure	Max. Working Pressure	Min. Bend Radius	Min. Bend Radius	Weight	Fitting
		in.	in.	mm	psi	MPa	in.	mm	lbs./ft.	
MIL-H-13444-III-4	20474735	3/16	0.49	12.5	1500	10.3	0.75	19.15	0.29	UC
MIL-H-13444-III-5	20479489	1/4	0.55	14.1	1500	10.3	1.00	25.40	0.28	UC
MIL-H-13444-III-6	20476712	5/16	0.62	15.7	1000	6.8	1.25	31.75	0.39	UC
MIL-H-13444-III-8	20477294	13/32	0.74	18.7	1000	6.8	1.75	44.45	0.47	UC
MIL-H-13444-III-10	20488137	1/2	0.83	21.1	875	6.0	2.25	31.75	0.47	UC
MIL-H-13444-III-12	20494896	5/8	0.96	24.3	750	5.1	2.75	69.85	0.32	UC
MIL-H-13444-III-16	20524468	7/8	1.21	30.6	375	2.6	3.50	88.90	0.44	UC
MIL-H-13444-III-20	20597709	1 1/4	1.49	37.8	300	2.0	4.50	114.3	0.50	UC

MIL-DTL-13444H-III

Military Applications

Compatible Fittings

This hose utilizes UCF9 ferrules with UniCrimp™ stems. For compatible fittings, see Section 5 (starting on page 242).

HOSE



MIL-DTL-13531

This hose is designed for medium- and high-pressure hydraulic systems.



PERFORMANCE + SPECS

Meets or exceeds the performance requirements of:

MIL-DTL-13531 Type II Class A

Inner Tube

NBR (Nitrile)

Reinforcement

Two braids of high-tensile steel wire

Cover

Black CR (Polychloroprene)

Temperature Range

-65°F to 200°F (-53.89°C to 93.33°C)

Qualification

QPL-13531 approved for bulk hose.

QPL-13531 approved for permanent UC fittings with UCF2 ferrules on factory assemblies. Distributor-made assemblies must seek DSCC approval.

KEY FEATURES



Military Applications
Type II Class A



4:1 Safety Factor

BRANDING

M13531-B8A 2Q18 63906

#	SAP	Hose Size ID	Hose OD		Max. Working Pressure		Min. Bend Radius		Weight	Fitting
Part Number	SAP Number	in.	in.	mm	psi	MPa	in.	mm	lbs./ft.	
M13531-B3A	20441525	3/16	0.63	15.9	5000	34.47	4.0	101.6	0.26	UC
M13531-B4A	20441526	1/4	0.69	17.5	5000	34.47	4.0	101.6	0.31	UC
M13531-B5A	20441527	5/16	0.75	19.1	4250	29.30	4.5	114.3	0.33	UC
M13531-B6A	20441528	3/8	0.84	21.4	4000	27.57	5.0	127.0	0.41	UC
M13531-B8A	20441529	1/2	0.97	24.6	3500	24.13	7.0	117.8	0.50	UC
M13531-B10A	20442170	5/8	1.09	27.8	2750	18.96	8.5	215.9	0.59	UC
M13531-B12A	20442171	3/4	1.25	31.8	2250	15.51	9.5	241.3	0.72	UC
M13531-B14A	20442172	7/8	1.38	34.9	2000	13.78	10.5	266.7	0.81	UC
M13531-B16A	20442173	1	1.56	39.7	2000	13.78	11.0	279.4	1.01	UC

HOSE

Continental

MIL-DTL-13531

Military Applications

Compatible Fittings

This hose utilizes UCF2 ferrules with UniCrimp™ stems.
For compatible fittings, see Section 5 (starting on page 242).

MIL-DTL-3992

MIL-DTL-3992 is a low-pressure hose for flexible connections in air brake systems on automotive vehicles.



PERFORMANCE + SPECS

Meets or exceeds the performance requirements of:

MIL-DTL-39921

Inner Tube

NBR (Nitrile)

Reinforcement

Two textile braids

Cover

Black CR (Polychloroprene)

Temperature Range

-60°F to 200°F (-51°C to 93°C)

KEY FEATURES



Military Applications
Type I Class I



4:1 Safety Factor

BRANDING

39921-B0112 2Q18 OZ 63906

#	SAP	Hose Size ID	Hose OD		Max. Working Pressure		Min. Bend Radius		Weight	Fitting
Part Number	SAP Number	in.	in.	mm	psi	MPa	in.	mm	lbs./ft.	
M3992-B0112	20024160	3/8	0.75	19.1	200	1.38	3.5	88.9	0.18	N/A
M3992-B0116	20568988	1/2	0.88	22.2	200	1.38	4.0	101.6	0.21	N/A

MIL-DTL-3992

Military Applications

HOSE



MIL-DTL-8788

MIL-DTL-8788 is designed for high-pressure hydraulic systems requiring interoperability and compatibility with associated components and equipment.



PERFORMANCE + SPECS

Meets or exceeds the performance requirements of:

MIL-DTL-8788

Inner Tube

NBR (Nitrile)

Reinforcement

Two braids of high-tensile steel wire

Cover

Black CR (Polychloroprene)

Temperature Range

-65°F to 160°F (-53.89°C to 71°C)

KEY FEATURES



Military Applications



4:1 Safety Factor

BRANDING

M8788-8 2Q18 63906

#	SAP	Hose Size ID	Hose OD	Max. Working Pressure	Min. Bend Radius	Weight	Fitting			
Part Number	SAP Number	in.	in.	mm	psi	MPa	in.	mm	lbs./ft.	
M8788-4	20024593	0.22	0.63	15.88	3000	20.68	3.00	76.20	0.27	N/A
M8788-5	20024596	0.28	0.70	17.86	3000	20.68	3.38	85.85	0.32	N/A
M8788-6	20024600	0.34	0.77	19.46	3000	20.68	5.00	127.00	0.37	N/A
M8788-8	20024604	0.44	0.86	21.82	3000	20.68	5.75	146.05	0.44	N/A
M8788-10	20024613	0.56	1.03	26.19	3000	20.68	6.50	165.10	0.57	N/A
M8788-12	20024616	0.69	1.22	30.96	3000	20.68	7.75	196.85	0.76	N/A
M8788-16	20024619	0.88	1.50	38.10	3000	20.68	9.63	244.60	1.32	N/A

HOSE

Continental

MIL-DTL-8788

Military Applications

PUSH-ON HOSE

	Page	Construction	Inner Tube	Working Pressure (psi)	Temperature Range	Fitting Series	Approvals	Packaging
INSTA-GRIP™ 300	86	Wire braid	Nitrile/PVC	300 psi	-40°F to 190°F	PB	MSHA	500' Reel, Various Cut Lengths
INSTA-GRIP™ TC	87	Wire braid	Nitrile/PVC	300 psi	-40°F to 200°F	PB		500' Reel, 50' Cut Lengths
INSTA-GRIP™ HT 300	88	Wire braid	Chlorinated Polyethylene	300 psi	-40°F to 300°F	PB		500' Reel
FXG	89	Wire braid	Nitrile/PVC	400 psi	-40°F to 200°F	PB	MSHA	500' Reel, Various Cut Lengths

PUSH-ON HOSE

HOSE

Continental 

Insta-Grip™ 300

Insta-Grip™ 300 is made for use with push-on fittings at maximum working pressures of 300 psi. It is for low-pressure hydraulic and pneumatic systems such as shop air systems, general industrial, maintenance and automotive applications. It is non-conductive, featuring a minimum electrical resistance greater than (1) megohm per inch of hose length at 1000V DC.



PERFORMANCE + SPECS

Meets flame resistance
USMSHA Designation

Inner Tube

NBR/PVC (Nitrile/PVC)

Reinforcement

One textile braid

Cover

Black, Blue, Red, Green, Gray
(for other colors contact marketing):
NBR/PVC (Nitrile/PVC), weather-,
abrasion- and oil-resistant (RMA
Class B Medium/High Oil Resistance)

Temperature Range

-40°F to 190°F (-40°C to 88°C)

KEY FEATURES



Non-conductive



4:1 Safety Factor

BRANDING



INSTA-GRIP™

300 PSI

1/2"

Flame
Resistant

MSHA 2G-1C-14C/33

MADE
IN USA

#	#	SAP									
Descriptive Number	Product Number	SAP Number	Hose Size ID	Hose OD	Max. Working Pressure	Min. Bend Radius	Weight	Fitting			
(***) Insert Color	(***) Insert Color	(Black)	in.	in.	mm	psi	MPa	in.	mm	lbs./ft.	
IG 300 1/4***	IG***-04	20022636	1/4	0.54	13.7	300	2.1	2.5	64	0.09	PB
IG 300 5/16***	IG***-05	20022641	5/16	0.62	15.7	300	2.1	3.0	76	0.12	PB
IG 300 3/8***	IG***-06	20022644	3/8	0.69	17.5	300	2.1	3.0	76	0.14	PB
IG 300 1/2***	IG***-08	20022648	1/2	0.81	20.6	300	2.1	5.0	127	0.16	PB
IG 300 5/8***	IG***-10	20022651	5/8	0.93	23.6	300	2.1	6.0	152	0.20	PB
IG 300 3/4***	IG***-12	20022653	3/4	1.07	27.2	300	2.1	7.0	178	0.25	PB
IG 300 1***	IG***-16	20136613 (Red)	1	1.34	34.0	300	2.1	8.0	203	0.34	PB

*** Colors: Black=BLK, Blue=BLU, Red=RED, Green=GRN, Gray=GRY

Note: Insta-Grip™ 300 black cover hose meets USMSHA 2G-1C-14C/33. All other colors meet USMSHA 2G-1C-14C/32.

HOSE



Insta-Grip™ 300

Low Pressure Push-On

Compatible Fittings

All fittings compatible with Insta-Grip™ 300 are listed in Section 10 (starting on page 370).

Insta-Grip™ TC

Insta-Grip™ TC is for low-pressure hydraulic and pneumatic systems such as shop air systems, general industrial, maintenance and automotive applications.



PERFORMANCE + SPECS

Inner Tube

NBR/PVC (Nitrile/PVC)

Reinforcement

One textile braid

Cover

Black textile braid, mildew- and oil-resistant

Temperature Range









-40°F to 200°F (-40°C to 93°C)

KEY FEATURES

4:1 4:1 Safety Factor

BRANDING

 **INSTA-GRIP™ TC 1/2" 300 PSI** MADE IN USA

										
Part Number	SAP Number	Hose Size ID	Hose OD		Max. Working Pressure		Min. Bend Radius		Weight	Fitting
		in.	in.	mm	psi	MPa	in.	mm	lbs./ft.	
IGTC-04	20022593	1/4	0.50	12.7	300	2.1	2.5	64	0.08	PB
IGTC-05	20022595	5/16	0.56	14.2	300	2.1	3.0	76	0.09	PB
IGTC-06	20022597	3/8	0.64	16.3	300	2.1	3.0	76	0.11	PB
IGTC-08	20022600	1/2	0.75	19.1	300	2.1	5.0	127	0.13	PB
IGTC-10	20022602	5/8	0.91	23.1	300	2.1	6.0	152	0.19	PB
IGTC-12	20022604	3/4	1.03	26.2	300	2.1	7.0	178	0.21	PB

Insta-Grip™ TC

Low Pressure

Compatible Fittings

All fittings compatible with Insta-Grip™ TC are listed in Section 10 (starting on page 370).

HOSE



Insta-Grip™ HT 300

Insta-Grip™ HT 300 is for lubricating as well as fuel oils, air and water. This hose is not recommended for applications involving impulse movements or air brake applications. IGHT can be used with push-on fittings at working pressures up to 300 psi.



PERFORMANCE + SPECS

Inner Tube

CPE (Chlorinated Polyethylene)

Reinforcement

One synthetic textile braid

Cover

Blue CPE (Chlorinated Polyethylene)
(ARPM Class B Oil Resistance)

Temperature Range

Petroleum-based hydraulic fluids:
-40°F to 300°F (-40°C to 150°C)
Water and air:
-40°F to 190°F (-40°C to 88°C)

KEY FEATURES



Handles high temperature



4:1 Safety Factor

BRANDING



INSTA-GRIP™ HT

1/2"

300 PSI

MADE
IN USA

#	SAP	Hose Size ID	Hose OD		Max. Working Pressure		Min. Bend Radius		Weight	Fitting
Part Number	SAP Number	in.	in.	mm	psi	MPa	in.	mm	lbs./ft.	
IGHT-04	20544196	1/4	0.51	12.8	300	2.1	2.5	64	0.09	PB
IGHT-06	20544197	3/8	0.67	17.0	300	2.1	3.0	76	0.14	PB
IGHT-08	20544198	1/2	0.76	19.3	300	2.1	5.0	127	0.16	PB
IGHT-10	20544199	5/8	0.93	23.6	300	2.1	6.0	152	0.20	PB
IGHT-12	20571923	3/4	1.04	26.5	300	2.1	7.0	178	0.25	PB

HOSE



Insta-Grip™ HT 300

Low Pressure Push-On

Compatible Fittings

All fittings compatible with Insta-Grip™ HT 300 are listed in Section 10 (starting on page 370).

FXG

FLEXAGrip™ is for use with push-on fittings at maximum working pressures of 400 psi. It is primarily for low-pressure hydraulic and pneumatic systems such as robotics, shop air systems, general industrial, maintenance and automotive applications. It is non-conductive, featuring a minimum electrical resistance greater than (1) megohm per inch of hose length at 1000 V DC.



PERFORMANCE + SPECS

Meets flame resistance
USMSHA Designation



Inner Tube
 NBR/PVC (Nitrile/PVC)

Reinforcement
 One textile braid

Cover
 Black, Blue, Red, Green, Gray, White, Brown and Yellow (for other colors contact marketing): Carbryn™, weather-, abrasion- and oil-resistant (ARPM Class A High Oil Resistance)









Temperature Range
 -40°F to 200°F (-40°C to 93°C)

KEY FEATURES

-  Non-conductive
-  4:1 Safety Factor

BRANDING

 **FXG (Non-Conductive)** **1/2" (12.7 MM)** **400 PSI 28 BAR** **Flame Resistant** **MSHA 2G-1C-14C/27** **MADE IN USA**

											
Descriptive Number	Product Number	SAP Number	Hose Size ID	Hose OD	Max. Working Pressure	Min. Bend Radius	Weight	Fitting			
(***) Insert Color	(***) Insert Color	(Black)	in.	in.	mm	psi	MPa	in.	mm	lbs./ft.	
FLEXAGrip™ 3/16***	FXG***-03	20022699	3/16	0.36	9.10	400	2.8	2.5	64	0.04	PB
FLEXAGrip™ 1/4***	FXG***-04	20022700	1/4	0.51	13.0	400	2.8	2.5	64	0.08	PB
FLEXAGrip™ 3/8***	FXG***-06	20022703	3/8	0.67	17.0	400	2.8	3.0	76	0.13	PB
FLEXAGrip™ 1/2***	FXG***-08	20022706	1/2	0.76	19.3	400	2.8	5.0	127	0.14	PB
FLEXAGrip™ 5/8***	FXG***-10	20022711	5/8	0.93	23.6	400	2.8	6.0	152	0.19	PB
FLEXAGrip™ 3/4***	FXG***-12	20022714	3/4	1.06	26.9	400	2.8	7.0	178	0.24	PB
FLEXAGrip™ 1***	FXG***-16	20141684	1	1.34	34.0	400	2.8	8.0	203	0.34	PB

*** Colors: Black=BLK, Blue=BLU, Red=RED, Green=GRN, Gray=GRY, White=WHT, Brown=BRN, Yellow=YEL

FXG
 Low Pressure Push-On

Compatible Fittings
 All fittings compatible with FXG are listed in Section 10 (starting on page 370).

HOSE

AIR CONDITIONING HOSE

	Page	Construction	Inner Tube	Working Pressure (psi)	Temperature Range	Fitting Series	Approvals	Packaging
GALAXY® G4826	91	Spiral	Chloroprene	350 - 500	-40°F to 200°F	AC	SAE J3062, SAE J2064*	250' Reel, 50' Cut Lengths
GALAXY® G4867	92	Polyester braid	Chloroprene	350	-40°F to 200°F	AC	SAE J3062, SAE J2064*	50' Cut Lengths
GALAXY® SLE G4890	93	Polyester braid	Chloroprene	350 - 500	-40°F to 200°F	AC	SAE J3062, SAE J2064*	250' Reel, Bulk Carton

*J2064 approval covers the assembly after proper testing has been completed and test data has been submitted for approval to SAE.

HOSE

Continental 

AIR CONDITIONING HOSE

Galaxy® G4826

This hose is recommended for R134a and R12 refrigerants in automotive, heavy-duty truck, construction and agricultural air conditioning systems.



PERFORMANCE + SPECS

Meets or exceeds the performance requirements of:

- SAE J3062
- SAE J2064,* Type C, Class II

Inner Tube

CR (Chloroprene)

Barrier

Nylon

Reinforcement

Two-spiral polyester

Cover

Black Chlorobutyl (CIIR)

Temperature Range

-22°F to 257°F (-30°C to 125°C)

KEY FEATURES



Air conditioning



4:1 Safety Factor

BRANDING



Galaxy® by Continental 4826-Size 8

SAE J2064 Type C Class II
1 3/32" (10.3 MM)

#	SAP	Hose Size ID	Hose OD	Max. Working Pressure	Min. Bend Radius	Weight	Fitting			
Part Number	SAP Number	in.	in.	mm	psi	MPa	in.	mm	lbs./ft.	
G4826-06	20290026	5/16	0.75	19.1	500	3.4	0.6	16	0.20	AC
G4826-08	20290027	13/32	0.91	23.0	500	3.4	1.0	25	0.28	AC
G4826-10	20290028	1/2	1.00	25.4	500	3.4	1.3	32	0.33	AC
G4826-12	20290029	5/8	1.13	28.6	350	2.4	2.0	50	0.38	AC

*J2064 approval covers the assembly after proper testing has been completed and test data has been submitted for approval to SAE.

Galaxy® G4826

Air Conditioning

Compatible Fittings

All fittings compatible with Galaxy® G4826 are listed in Section 8 (starting on page 303).

HOSE



Galaxy® G4867

Galaxy® G4867 is recommended for R134a, refrigerant blends and compressor lubricants as a suction line in air conditioning systems for heavy-duty trucks.



PERFORMANCE + SPECS

Meets or exceeds the performance requirements of:

- SAE J3062
- SAE J2064,* Type C, Class II

Inner Tube
CR (Chloroprene)



Barrier
Nylon

Reinforcement
Single-braid polyester

Cover
Black Chlorobutyl (CIIR)

Temperature Range
-22°F to 257°F (-30°C to 125°C)

KEY FEATURES

-  Air conditioning
-  4:1 Safety Factor

BRANDING

 **Galaxy® by Continental** 4867-Size 8 SAE J2064 Type C Class I 13/32" (10.3 MM)

#	SAP	Hose Size ID	Hose OD		Max. Working Pressure		Min. Bend Radius		Weight	Fitting
Part Number	SAP Number	in.	in.	mm	psi	MPa	in.	mm	lbs./ft.	AC
G4867-14	20306586	3/4	1.13	28.6	350	2.4	6.3	160	0.26	AC

*J2064 approval covers the assembly after proper testing has been completed and test data has been submitted for approval to SAE.

HOSE



Galaxy® G4867
Air Conditioning

Compatible Fittings

All fittings compatible with Galaxy® G4867 are listed in Section 8 (starting on page 303).

Galaxy® SLE G4890

This hose is recommended for R134a, R1234yf, and refrigerant blends and compressor lubricants in automotive and heavy-duty truck air conditioning systems where significant reduction in permeation and moisture ingress is desired.



PERFORMANCE + SPECS

Meets or exceeds the performance requirements of:

- SAE J3062
- SAE J2064,* Type C, Class II

Inner Tube

CR (Chloroprene)

Barrier

Nylon

Reinforcement

Single-braid polyester

Cover

Black Chlorobutyl (CIIR)

Temperature Range

-40°F to 275°F (-40°C to 135°C)

KEY FEATURES



Air conditioning



4:1 Safety Factor

BRANDING



Galaxy® by Continental

4890-Size 8

SAE J2064 Type C Class II
1 3/32" (10.3 MM)

#	SAP	Hose Size ID	Hose OD		Max. Working Pressure		Min. Bend Radius		Weight	Fitting
Part Number	SAP Number	in.	in.	mm	psi	MPa	in.	mm	lbs./ft.	
G4890-06	20306246	5/16	0.56	14.7	500	3.4	1.0	25	0.09	AC
G4890-08	20306247	13/32	0.69	17.3	500	3.4	1.5	38	0.12	AC
G4890-10	20306248	1/2	0.75	19.4	500	3.4	2.5	63	0.13	AC
G4890-12	20306249	5/8	0.94	23.6	350	2.4	4.0	104	0.20	AC

*J2064 approval covers the assembly after proper testing has been completed and test data has been submitted for approval to SAE.

Galaxy® SLE G4890

Air Conditioning

Compatible Fittings

All fittings compatible with the Galaxy® SLE G4890 are listed in Section 8 (starting on page 303).

HOSE



THERMOPLASTIC HOSE

	Page	Construction	Inner Tube	Working Pressure (psi)	Temperature Range	Fitting Series	Approvals	Packaging
SR7	95	Synthetic fiber	Nylon	1000-2500	-40°F to 212°F	T7	SAE 100R7, EN 857 R7	50' and 250' Box
SR8	96	Synthetic fiber	Polyester	3500-5000	-40°F to 212°F	T8	SAE 100R8, EN 855 R8	50' and 250' Box
NR7	97	Synthetic fiber	Polyester	1000-3000	-65°F to 212°F	T7	SAE 100R7	50' and 250' Box
NR8	98	Synthetic fiber	Nylon	3500-5000	-40°F to 212°F	T8	SAE 100R8	250' Box
TR7	99	Synthetic fiber	Nylon	3500-5000	-40°F to 212°F	T7	SAE 100R7	250' Box
TR8	100	Synthetic fiber	Nylon	3500-4000	-40°F to 212°F	T8	SAE 100R8	250' Box
BR7	101	Synthetic fiber	Polyester	2250-2750	-65°F to 212°F	T7	SAE 100R7	50' and 250' Box
SR18	102	Synthetic fiber	Polyester	3000	-65°F to 201°F	T7	SAE 100R18	250' Box

HOSE



THERMOPLASTIC HOSE

SR7

SR7 is a medium-pressure, thermoplastic hose with a perforated cover. It is compatible with petroleum-, water- and synthetic-based fluids for mobile equipment, lube lines, blowout preventers, hydraulic lifts and construction machinery.

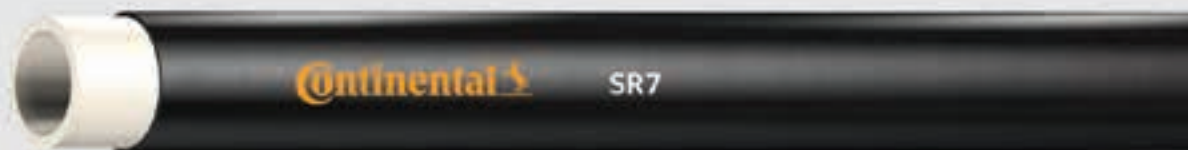

PERFORMANCE + SPECS

Meets or exceeds the performance requirements of:

SAE 100R7
EN 857 R7

Exceeds SAE minimum bend radius

Inner Tube

Nylon

Reinforcement

Synthetic fiber

Cover

Black urethane, pin-pricked

Temperature Range

-40°F to 212°F (-40°C to 100°C)

Note: Maximum temperature for water-based and fire-resistant fluids is 150°F (66°C)









KEY FEATURES

 Made for tight bends

 4:1 Safety Factor

BRANDING

 **SR7-08** SAE 100R7 / EN 855 R7 1/2" (DN12) **2000 PSI (13.8 MPa)**

										
Part Number	SAP Number	Hose Size ID	Hose OD		Max. Working Pressure		Min. Bend Radius		Weight	Fitting
		in.	in.	mm	psi	MPa	in.	mm	lbs./ft.	
SR7-02	20243607	1/8	0.34	8.5	2500	17.2	0.5	13	0.03	T7
SR7-03	20243608	3/16	0.43	10.8	3000	20.7	0.8	20	0.05	T7
SR7-04	20243609	1/4	0.51	13.0	3000	20.7	1.3	33	0.06	T7
SR7-05	20243650	5/16	0.59	15.1	2500	17.2	1.8	46	0.07	T7
SR7-06	20243651	3/8	0.67	17.0	2250	15.5	2.0	51	0.10	T7
SR7-08	20243652	1/2	0.82	20.7	2000	13.8	3.0	76	0.14	T7
SR7-12	20243653	3/4	1.07	27.1	1250	8.6	5.0	127	0.19	T7
SR7-16	20243654	1	1.34	34.0	1000	6.9	8.0	203	0.26	T7

SR7

Thermoplastic

Compatible Fittings

All fittings compatible with SR7 are listed in Section 7 (starting on page 286).

HOSE



SR8

SR8 is a high-pressure thermoplastic hose with a perforated cover for petroleum-, water- and synthetic-based fluids for mobile equipment, lube lines, blowout preventers, hydraulic lifts and construction machinery.



PERFORMANCE + SPECS

Meets or exceeds the performance requirements of:

SAE 100R8
EN 855 R8

Exceeds SAE minimum bend radius

Inner Tube
Polyester

Reinforcement
Synthetic fiber

Cover
Black urethane, pin-pricked

Temperature Range
-40°F to 212°F (-40°C to 100°C)
Note: Maximum temperature for water-based and fire-resistant fluids is 150°F (66°C)

KEY FEATURES

4:1 4:1 Safety Factor

BRANDING



SR8-08

SAE 100R8 / EN 855 R8
1/2" (DN12)

3500 PSI (24.1 MPa)

#	SAP	Hose Size ID	Hose OD		Max. Working Pressure		Min. Bend Radius		Weight	Fitting
Part Number	SAP Number	in.	in.	mm	psi	MPa	in.	mm	lbs./ft.	
SR8-03	20243672	3/16	0.52	13.1	5000	34.5	1.5	38	0.08	T8
SR8-04	20243673	1/4	0.63	15.9	5000	34.5	2.0	51	0.12	T8
SR8-06	20243674	3/8	0.77	19.4	4000	27.6	2.5	64	0.15	T8
SR8-08	20243675	1/2	0.89	22.7	3500	24.1	4.0	102	0.19	T8

HOSE



SR8

Thermoplastic

Compatible Fittings

All fittings compatible with SR8 are listed in Section 7 (starting on page 286).

NR7

NR7 is a medium-pressure thermoplastic hose with a non-perforated cover. This hose is compatible with petroleum-, water- and synthetic-based fluids for mobile equipment, lube lines, blowout preventers, hydraulic lifts and construction machinery requiring SAE 100R7 non-conductivity standards.



PERFORMANCE + SPECS

Meets or exceeds the performance requirements of:

SAE 100R7

Inner Tube

Polyester

Reinforcement

Synthetic fiber

Cover

Orange urethane

Temperature Range

-65°F to 212°F (-54°C to 100°C)

Sizes 1/8", 3/4" and 1"

-40°F to 200°F (-40°C to 93°C)

Note: Maximum temperature for water-based and fire-resistant fluids is 140°F (60°C)

KEY FEATURES



Non-conductive



4:1 Safety Factor

BRANDING



NR7-08

SAE 100R7 (Non-Conductive)
1/2" (12.7 MM)

2250 PSI (15.5 MPa)

#	SAP	Hose Size ID	Hose OD		Max. Working Pressure		Min. Bend Radius		Weight	Fitting
Part Number	SAP Number	in.	in.	mm	psi	MPa	in.	mm	lbs./ft.	
NR7-03	20243656	3/16	0.43	10.8	3000	20.7	0.8	20	0.05	T7
NR7-04	20243657	1/4	0.49	12.3	2750	19.1	1.3	33	0.06	T7
NR7-05	20243658	5/16	0.58	14.7	2500	17.2	1.8	46	0.08	T7
NR7-06	20243659	3/8	0.64	16.1	2250	15.5	2.0	51	0.10	T7
NR7-08	20243660	1/2	0.82	20.7	2250	15.5	3.0	76	0.14	T7
NR7-12	20243661	3/4	1.07	27.1	1250	8.6	5.0	127	0.19	T7
NR7-16	20243662	1	1.34	34.0	1000	6.9	8.0	203	0.26	T7

NR7

Thermoplastic

Compatible Fittings

All fittings compatible with NR7 are listed in Section 7 (starting on page 286).

HOSE



NR8

NR8 is a high-pressure, thermoplastic hose with a non-perforated cover. It is compatible with petroleum-, water- and synthetic-based fluids for mobile equipment, lube lines, blowout preventers, hydraulic lifts and construction machinery requiring SAE 100R8 non-conductivity standards.



PERFORMANCE + SPECS

Meets or exceeds the performance requirements of:

SAE 100R8

Inner Tube

Nylon

Reinforcement

Synthetic fiber

Cover

Orange urethane

Temperature Range

-40°F to 212°F (-40°C to 100°C)

Note: Maximum temperature for water-based and fire-resistant fluids is 150°F (66°C)

KEY FEATURES



Non-conductive



4:1 Safety Factor

BRANDING



NR8-08

SAE 100R8 (Non-Conductive)
1/2" (DN12)

3500 PSI (24.1 MPa)

#	SAP	Hose Size ID	Hose OD	Max. Working Pressure	Min. Bend Radius	Weight	Fitting
Part Number	SAP Number	in.	in.	psi	in.	lbs./ft.	
NR8-04	20243676	1/4	0.63	5000	2.0	0.12	T8
NR8-06	20243677	3/8	0.77	4000	2.5	0.15	T8
NR8-08	20243678	1/2	0.89	3500	4.0	0.19	T8

HOSE



NR8

Thermoplastic

Compatible Fittings

All fittings compatible with NR8 are listed in Section 7 (starting on page 286).

TR7

TR7 is a medium-pressure, twin-line thermoplastic hose with a perforated cover. It is compatible with petroleum-, water- and synthetic-based fluids for mobile equipment, lube lines, blowout preventers, hydraulic lifts and construction machinery.



PERFORMANCE + SPECS

Meets or exceeds the performance requirements of:

SAE 100R7

Inner Tube

Nylon

Reinforcement

Synthetic fiber

Cover

Black urethane, pin-pricked

Temperature Range

-40°F to 212°F (-40°C to 100°C)

Note: Maximum temperature for water-based and fire-resistant fluids is 150°F (66°C)

KEY FEATURES



Twin-Line Hose



4:1 Safety Factor

BRANDING



TR7-08

SAE 100R7
1/2" (DN12)

2000 PSI (13.8 MPa)

#	SAP	Hose Size ID	Hose OD		Max. Working Pressure		Min. Bend Radius		Weight	Fitting
Part Number	SAP Number	in.	in.	mm	psi	MPa	in.	mm	lbs./ft.	
TR7-03	20243663	3/16	0.43	10.8	3000	20.7	0.8	20	0.09	T7
TR7-04	20243664	1/4	0.51	13.0	3000	20.7	1.3	33	0.11	T7
TR7-05	20243665	5/16	0.59	15.1	2500	17.2	1.8	46	0.14	T7
TR7-06	20243666	3/8	0.67	17.0	2250	15.5	2.0	51	0.19	T7
TR7-08	20243667	1/2	0.82	20.7	2000	13.8	3.0	76	0.28	T7

TR7

Thermoplastic

Compatible Fittings

All fittings compatible with TR7 are listed in Section 7 (starting on page 286).

HOSE



TR8

TR8 is a high-pressure, twin-line thermoplastic hose with a perforated cover. It is compatible with petroleum-, water- and synthetic-based fluids for mobile equipment, lube lines, blowout preventers, hydraulic lifts and construction machinery.



PERFORMANCE + SPECS

Meets or exceeds the performance requirements of:

SAE 100R8

Inner Tube

Nylon

Reinforcement

Synthetic fiber

Cover

Black urethane, pin-pricked

Temperature Range

-40°F to 212°F (-40°C to 100°C)

Note: Maximum temperature for water-based and fire-resistant fluids is 150°F (66°C)

KEY FEATURES



Twin-Line Hose



4:1 Safety Factor

BRANDING



TR8-08

SAE 100R8
1/2" (DN12)

3500 PSI (24.1 MPa)



Part Number



SAP Number



Hose Size ID



Hose OD



Max. Working Pressure



Min. Bend Radius



Weight



Fitting

		in.	in.	mm	psi	MPa	in.	mm	lbs./ft.	
TR8-06	20243679	3/8	0.77	19.4	4000	27.6	2.5	64	0.30	T8
TR8-08	20416222	1/2	0.89	22.7	3500	24.1	4.0	102	0.38	T8

HOSE



TR8

Thermoplastic

Compatible Fittings

All fittings compatible with TR8 are listed in Section 7 (starting on page 286).

BR7

BR7 is a medium-pressure, twin-line thermoplastic hose with a non-perforated cover. It is compatible with petroleum-, water- and synthetic-based fluids for mobile equipment, lube lines, blowout preventers, hydraulic lifts and construction machinery requiring SAE 100R7 non-conductivity standards.



PERFORMANCE + SPECS

Meets or exceeds the performance requirements of:

SAE 100R7

Inner Tube

Polyester

Reinforcement

Synthetic fiber

Cover

Orange urethane

Temperature Range

-65°F to 212°F (-54°C to 100°C)

Note: Maximum temperature for water-based and fire-resistant fluids is 150°F (66°C)

KEY FEATURES



Non-conductive



Twin-Line Hose



4:1 Safety Factor

BRANDING



BR7-08

SAE 100R7 (Non-Conductive)
1/2" (DN12)

2250 PSI (15.5 MPa)

Part Number	SAP Number	Hose Size ID	in.	in.	mm	psi	MPa	in.	mm	lbs./ft.	Fitting
BR7-04	20243684	1/4	0.49	12.3	2750	19.1	1.3	33	0.12	T7	
BR7-05	20243685	5/16	0.58	14.7	2500	17.2	1.8	46	0.15	T7	
BR7-06	20243686	3/8	0.64	16.1	2250	15.5	2.0	51	0.19	T7	
BR7-08	20243687	1/2	0.82	20.7	2250	15.5	3.0	76	0.29	T7	

BR7

Thermoplastic

Compatible Fittings

All fittings compatible with BR7 are listed in Section 7 (starting on page 286).

HOSE



SR18

SR18 is a highly flexible thermoplastic hose, even in cold temperatures. It has a compact size with a small OD and a lightweight, yet rugged, construction. Applications for this hose include forklifts, construction equipment, general hydraulic applications, chemical and gas transfer, agricultural equipment, material handling, freezer applications, machine tools and robotics, lubrication equipment and portable hydraulic tools.



PERFORMANCE + SPECS

Meets or exceeds the performance requirements of:

SAE 100R18

Inner Tube

Polyester

Reinforcement

Synthetic fiber

Cover

Black Polyester

Temperature Range

-65°F to 201°F (-54°C to 94°C)

Note: Maximum temperature for water-based and fire-resistant fluids is 150°F (66°C)

KEY FEATURES



Handles low temperature



Flexible at low temperature



4:1 Safety Factor

BRANDING



SR18-08

SAE 100R18
1/2" (12.7 MM)

3000 PSI (20.7 MPa)

#	SAP	Hose Size ID	Hose OD	Max. Working Pressure	Min. Bend Radius	Weight	Fitting			
Part Number	SAP Number	in.	in.	psi	MPa	in.	mm	lbs./ft.		
SR18-04	20243680	1/4	0.49	12.3	3000	20.7	1.3	32	0.06	T7
SR18-05	20243681	5/16	0.61	15.5	3000	20.7	1.5	38	0.08	T7
SR18-06	20243682	3/8	0.66	16.8	3000	20.7	2.0	51	0.12	T7
SR18-08	20243683	1/2	0.85	21.6	3000	20.7	3.5	89	0.15	T7

HOSE



SR18

Thermoplastic

Compatible Fittings

All fittings compatible with SR18 are listed in Section 7 (starting on page 286).

SUCTION / RETURN HOSE

	Page	Construction	Inner Tube	Working Pressure (psi)	Temperature Range	Fitting Series	Approvals	Packaging
HR4	104	Spiral	Nitrile	100-350	-40°F to 275°F	UC, BT	MSHA, SAE 100R4, USCG	100' Coil

SUCTION / RETURN HOSE

HR4

HR4 is a low-pressure, high-temperature return line or suction line for petroleum- and water-based hydraulic fluids. It has a vacuum rating of 25 in Hg. HR4 has half the bend radius of the typical SAE 100R4.



PERFORMANCE + SPECS

Meets or exceeds the performance requirements of:

SAE 100R4

Meets flame resistance
USMSHA Designation

Inner Tube
NBR (Nitrile)

Reinforcement

Spiral-plied synthetic fabric with wire helix

Cover

Black CR (Polychloroprene)

Temperature Range

-40°F to 275°F (-40°C to 135°C)

KEY FEATURES



Handles high temperature



SAE J1942/
U.S. Coast Guard



1/2 Bend



4:1 Safety Factor

BRANDING



HR4-12

SAE 100R4
3/4" (19 MM)

350 PSI (2.41 MPa)

MSHA IC-233/O 2Q18

MADE IN
CANADA

#	SAP	Hose Size ID	Hose OD		Max. Working Pressure		Min. Bend Radius		Weight	Fitting
Part Number	SAP Number	in.	in.	mm	psi	MPa	in.	mm	lbs./ft.	
HR4-12	20325410	3/4	1.162	29.5	350	2.41	2.5	64	0.41	UC, BT
HR4-16	20325411	1	1.460	37.1	325	2.2	3.0	76	0.59	UC, BT
HR4-20	20325412	1 ¼	1.712	43.5	250	1.72	4.0	102	0.72	UC, BT
HR4-24	20325413	1 ½	1.963	49.9	225	1.55	5.0	127	0.85	UC, BT
HR4-32	20325414	2	2.464	62.6	225	1.55	6.0	152	1.12	UC, BT
HR4-40	20325415	2 ½	2.971	75.5	140	0.97	7.0	178	1.45	UC, BT
HR4-48	20325416	3	3.533	89.8	135	0.93	9.0	229	1.90	UC, BT
HR4-64	20325418	4	4.542	115.4	100	0.69	12	305	2.68	UC, BT

HOSE



HR4

Low Pressure

Compatible Fittings

UC fittings are listed in Section 5 (starting on page 242).
BT fittings are listed in Section 4 (starting on page 236).

READY 2 GO ASSEMBLIES

R2G TIME IS MONEY. AND WE ARE SAVING YOU BOTH.

We know your time is valuable. That is why we want to help you get back to doing what you do best, faster. The **Ready 2 Go (R2G)** system has pre-coupled Continental hose assemblies ready for delivery, so you can do less waiting.

And since the R2G System is available in thirty-seven different hose families, you can rely on us to have the hose you need, when you need it. It is convenience on a whole new level.



Neptune™ 1500

For pressure washer equipment, agricultural sprayers and high-pressure air lines with working pressures up to 1500 psi. Rated to temperatures of -20°F to 200°F (-29°C to 93°C).

Tube
Nitrile synthetic rubber

Cover
Blue, Gray, Yellow or Black oil-resistant synthetic rubber, RMA Class B (Medium Oil Resistance)

Reinforcement
Braided (1) synthetic yarn up through 1/2"
Braided (2) synthetic yarn for 3/4"

Part Number	Hose Color	Hose Size ID	Packaging	Length
		in.		ft.
20023123	Black	3/8	MXMS with Kink Guards	50
20023125	Black	3/8	MXMS with Kink Guards	100
20070397	Grey	3/8	MXMS with Kink Guards	75



Ready 2 Go Assemblies

HOSE
Continental



Neptune™ 3000

For use on pressure washer machines with working pressures up to 3000 psi. Rated to temperatures of -20°F to 250°F (-29°C to 121°C).

Tube

Nitrile synthetic rubber

Cover

Black, Blue, Yellow or Gray oil-resistant synthetic rubber, RMA Class B (Medium Oil Resistance)

Reinforcement

Braided (1) steel wire

Part Number	Hose Color	Hose Size ID		Packaging	Length
			in.		
20023553	Black	3/8		MXMS w/ Kink Guards	25
20023570	Black	3/8		MXMS w/ Kink Guards	50
20023573	Black	3/8		MXMS w/ Kink Guards	75
20023581	Black	3/8		MXMS w/ Kink Guards	100
20023611	Black	1/2		MXMS w/ Kink Guards	50
20023613	Black	1/2		MXMS w/ Kink Guards	100
20023694	Blue	3/8		MXMS w/ Kink Guards	25
20023695	Blue	3/8		MXMS w/ Kink Guards	30
20023696	Blue	3/8		MXMS w/ Kink Guards	40
20023699	Blue	3/8		MXMS w/ Kink Guards	50
20023703	Blue	3/8		MXMS w/ Kink Guards	75
20023705	Blue	3/8		MXMS w/ Kink Guards	100
20023717	Blue	1/2		MXMS w/ Kink Guards	50
20031720	Blue	1/2		MXMS w/ Kink Guards	100
20140094	Gray	3/8		MXMS w/ Kink Guards	40
20023740	Gray	3/8		MXMS w/ Kink Guards	50
20116289	Gray	3/8		MXMS w/ Kink Guards	75
20112264	Gray	3/8		MXMS w/ Kink Guards	100



Neptune™ 4001-R

For high-pressure washer equipment with working pressures up to 4000 psi. Rated to temperatures of -20°F to 250°F (-29°C to 121°C).

Tube

Nitrile synthetic rubber

Cover

Blue, Gray, Yellow or Black oil-resistant synthetic rubber, RMA Class B (Medium Oil Resistance)

Reinforcement

Braided (1) steel wire

Part Number	Hose Color	Hose Size ID		Packaging	Length
			in.		
20141700	Black	3/8		MXMS w/ Kink Guards	25
20119464	Black	3/8		MXMS w/ Kink Guards	50
20141702	Black	3/8		MXMS w/ Kink Guards	75
20129270	Black	3/8		MXMS w/ Kink Guards	100
20119465	Blue	3/8		MXMS w/ Kink Guards	50
20135601	Yellow	3/8		MXMS w/ Kink Guards	50



Neptune™ 4500

For use on pressure washer machines with working pressures up to 4500 psi. Rated to temperatures of -20°F to 250°F (-29°C to 121°C).

Tube
Nitrile synthetic rubber

Cover
Blue, Gray, Yellow or Black oil-resistant synthetic rubber, RMA Class B (Medium Oil Resistance)

Reinforcement
Braided (1) steel wire

Part Number	Hose Color	Hose Size ID	Packaging	Length
		in.		ft.
20023775	Black	3/8	MXMS w/ Kink Guards	50
20023778	Black	3/8	MXMS w/ Kink Guards	75
20023785	Black	3/8	MXMS w/ Kink Guards	100
20023796	Black	1/2	MXMS w/ Kink Guards	50
20023799	Black	1/2	MXMS w/ Kink Guards	100
20024007	Blue	3/8	MXMS w/ Kink Guards	50
20142226	Blue	3/8	MXMS w/ Kink Guards	75
20046210	Blue	3/8	MXMS w/ Kink Guards	100



Neptune™ 6000

For use on pressure washer machines with working pressures up to 6000 psi. Rated to temperatures of -20°F to 250°F (-29°C to 121°C).

Tube
Nitrile synthetic rubber

Cover
Black oil resistant synthetic rubber
RMA Class B (Medium Oil Resistance)

Reinforcement
Braided (2) steel wires

Part Number	Hose Color	Hose Size ID	Packaging	Length
		in.		ft.
20130010	Black	3/8	MXMS with Kink Guards	50
20133521	Black	3/8	MXMS with Kink Guards	100



Ready 2 Go Assemblies

HOSE





F5™ Air Hose

A hybrid thermoplastic hose that provides durability and flexibility, is lightweight and has a low drag resistance. F5™ is non-marking, oil resistant and performs well under cold temperatures to -40°F (-40°C) and temperatures as high as 158°F (70°C). This 300 psi hose is designed for a variety of pneumatic applications in industries such as construction and manufacturing.

Tube

Blue Flexible TPE, RMA Class B
(Medium Oil Resistance)

Cover

Matte Blue Flexible TPE, RMA Class B
(Medium Oil Resistance)

Reinforcement

Polyester yarn

Part Number	Hose Color	Hose Size ID	Packaging	Length
		in.		ft.
20465479	Blue	3/8	MXM 3/8 NPT	25
20465480	Blue	3/8	MXM 3/8 NPT	100
20465473	Blue	1/2	MXM 1/2 NPT	25
20465474	Blue	1/2	MXM 1/2 NPT	50
20465485	Blue	1/4	MXM 1/4 NPT	25
20463349	Blue	1/4	MXM 1/4 NPT	10
20465487	Blue	1/4	MXM 1/4 NPT	100
20470808	Blue	3/8	MXM 1/4 NPT	50
20479683	Blue	3/8	MXM 3/8 NPT	50



Frontier®

An economical air and water hose, Frontier® is for a wide range of industrial, construction and agricultural applications. Available in 200, 250 and 300 psi working pressures with a temperature rating of -40°F to 190°F (-40°C to 88°C).

Cover

Black, Red, Yellow, Green or
Blue EPDM synthetic rubber

Reinforcement

Spiral synthetic yarn, 2" is braided

Tube

EPDM synthetic rubber, RMA Class C (Limited
Oil Resistance)

Product Name	Part Number	Hose Color	Hose Size ID	Packaging	Length
			in.		ft.
Frontier 200	20129541	Red	1/4	MXM 1/4 NPT	25
Frontier 200	20132830	Red	1/4	MXM 1/4 NPT	50
Frontier 200	20129680	Red	3/8	MXM 1/4 NPT	25
Frontier 200	20132831	Red	3/8	MXM 1/4 NPT	50
Frontier 200	20129682	Red	3/8	MXM 1/4 NPT	100
Frontier 200	20132832	Red	1/2	MXM 1/2 NPT	50
Frontier 250	20147652	Red	3/4	MXM 3/4 NPT	100
Frontier 300	20147625	Red	1/4	MXM 1/4 NPT	50
Frontier 300	20147626	Red	1/4	MXM 1/4 NPT	100
Frontier 300	20147627	Red	3/8	MXM 1/4 NPT	50
Frontier 300	20147628	Red	3/8	MXM 1/4 NPT	100
Frontier 200	20147629	Red	1/2	MXM 1/2 NPT	50
Frontier 200	20147650	Red	1/2	MXM 1/2 NPT	100

HOSE

Continental



Ready 2 Go Assemblies



Gorilla®

A premium-quality, multipurpose industrial hose with a wide range of applications in factories, construction, agriculture, quarries, mines, railroads, the oil and gas industry and shipbuilding. All sizes are rated at 500 psi (3.4 MPa) maximum working pressure and have temperature ratings of -20°F to 190°F (-29°C to 88°C). Non-conductive, minimum electrical resistance greater than one (1) megohm per inch of hose length at 1000 Volts DC.

Tube

Nitrile synthetic rubber, RMA Class A (High Oil Resistance)

Cover

Yellow Carbryn™ synthetic rubber, RMA Class A (High Oil Resistance), MSHA approved

Reinforcement

Spiral aramid yarn, 2" is braided synthetic yarn

Part Number	Hose Color	Hose Size ID	Packaging	Length
		in.		ft.
20129563	Yellow	1/4	MXM 1/4 NPT	25
20132763	Yellow	1/4	MXM 1/4 NPT	50
20129566	Yellow	3/8	MXM 3/8 NPT	25
20132764	Yellow	3/8	MXM 3/8 NPT	50
20129569	Yellow	1/2	MXM 1/2 NPT	25
20132766	Yellow	1/2	MXM 1/2 NPT	50
20129582	Yellow	3/4	MXM 3/4 NPT	50
20129683	Yellow	3/4	Universal	50



Contractor's Water Hose

Designed for commercial water transfer and washdown applications requiring heavy duty service. Rated to temperatures of -40°F to 190°F (-40°C to 88°C).

Tube EPDM

Cover Black EPDM

Reinforcement

Spiral synthetic yarn

Part Number	Hose Color	Hose Size ID	Packaging	Length
		in.		ft.
20243769	Black	5/8	MF GHT	50
20243770	Black	3/4	MF GHT	50



Pathfinder™ Garden Hose

For in-home, lawn and garden, apartment, smaller plant and commercial property applications. Rated to temperatures of -40°F to 190°F (-40°C to 88°C).

Cover

Green EPDM synthetic rubber

Reinforcement

Spiral synthetic yarn

Tube
EPDM synthetic rubber

Part Number	Hose Color	Hose Size ID	Packaging	Length
		in.		ft.
20026217	Green	5/8	MF Brass 5/8" GHT	50



Ready 2 Go Assemblies

HOSE
Continental

Yardmaster™ Garden Hose



Experience the next generation of garden hose. Rated to temperatures of -40°F to 158°F (-40°C to 70°C).

Features

- › Thermoplastic Elastomer hybrid materials
- › 20% lighter than rubber garden hose
- › Improved flexibility at low temperatures

Part Number	Hose Color	Hose Size ID	Packaging	Length
		in.		ft.
20583057	Green	5/8	MF Brass 5/8" GHT	50
20530170	Green	1/2	MF Brass 1/2" GHT	50

Heavy Duty & Cold Water Premium Rubber Hose



A commercial premium rubber hose. Rated to temperatures of -40°F to 160°F (-40°C to 71°C).

Features

- › Reinforced for high burst strength
- › Abrasion- and weather-resistant
- › Crush-resistant brass fittings

Part Number	Hose Color	Hose Size ID	Packaging	Length
		in.		ft.
20582671	Black	5/8	MF Brass 5/8" GHT	50

Heavy Duty & Hot Water Premium Rubber Hose



A commercial premium hot-water hose. Rated to temperatures of -40°F to 190°F (-40°C to 88°C).

Features

- › Abrasion-resistant
- › Flexible in cold temperatures
- › Internal spring coil prevents kinking at faucet
- › Crush-resistant brass fittings

Part Number	Hose Color	Hose Size ID	Packaging	Length
		in.		ft.
20582672	Red	5/8	MF Brass 5/8" GHT	50



Twin-Line Welding (Grade R Type VD)

For welding service. Meets RMA IP-7 standard for Grade R welding hose. Rated to temperatures of -40°F to 120°F (-40°C to 49°C).

Tube

EPDM synthetic rubber compatible with oxygen and acetylene gases

Cover

EPDM synthetic rubber smooth surface

Reinforcement

Spiral synthetic yarn

Part Number	Hose Color	Hose Size ID	Packaging	Length
		in.		ft.
20027151	Red/Green	1/4	1/4" Grade R Type BB Fit	25
20027152	Red/Green	1/4	1/4" Grade R Type BB Fit	50
20027153	Red/Green	1/4	1/4" Grade R Type BB Fit	100



Twin-Line Welding (Grade T Type VD)

For welding service. Meets RMA IP-7 and CGA E-1 standards for Grade T welding hose. Non-conductive. Rated to temperatures of -40°F to 120°F (-40°C to 49°C).

Tube

Synthetic rubber compatible with all common welding fuel gases

Cover

Chemivac synthetic rubber smooth cover

Reinforcement

Spiral synthetic yarn

Part Number	Hose Color	Hose Size ID	Packaging	Length
		in.		ft.
20027453	Red/Green	1/4	1/4" Grade T Type BB Fit.	50
20027454	Red/Green	1/4	1/4" Grade T Type BB Fit.	100
20027493	Red/Green	3/8	3/8" Grade T Type BB Fit.	25
20027495	Red/Green	3/8	3/8" Grade T Type BB Fit.	50
20027497	Red/Green	3/8	3/8" Grade T Type BB Fit.	100

Welding Hose Compatibility Chart

	Oxygen	Acetylene	Fuel Gases*	Flame & Oil Resistant Tube	Flame & Oil Resistant Tube
Twin-Line, Grade R	Yes	Yes	No	No	No
Twin-Line, Grade RM	Yes	Yes	No	No	Yes
Twin-Line, Grade T	Yes	Yes	Yes	Yes	Yes
Single-Line, Grade R	Yes	Yes	No	No	No
Single-Line, Grade RM	Yes	Yes	No	No	Yes
Single-Line, Grade T	Yes	Yes	Yes	Yes	Yes

*Fuel gases are defined in RMA IP-7 welding hose standard. Flammable compressed gases commonly used in the welding and cutting industry including, but not limited to, acetylene, hydrogen, methane/natural gas, LP gas, propylene and methylacetylene propadiene stabilized. RMA IP-7 and CGA E-1.



Ready 2 Go Assemblies

HOSE



Hose Working Pressure Selection Guide

Hose Dash Size and Recommended Working Pressures

This table is to be used as a guide in the selection of hose by maximum working pressure. The recommended maximum working pressure should not be the only factor in hose selection. Final selection of the hose is further dependent on fluid and ambient temperatures, the concentration of the fluid and intermittent or continuous exposure.

Pressure Range	Family Part #	Hose Description	Dash Size							
			02	03	04	05	06	08	10	12
			Hose ID							
			1/8"	3/16"	1/4" R5, UT: 3/16"	5/16" R5, UT: 1/4"	3/8" R5: 5/16"	1/2" R5, UT, AC: 13/32"	5/8" R5, UT, AC: 1/2"	3/4" R5, UT, AC: 5/8"
Low Pressure	SR6	SAE 100R6 / EN 854 R6		500	400	400	400	400	350	300
	HR6	SAE 100R6 / EN 854 R6 (High Temperature)			400	400	400	400	350	300
	HR4	SAE 100R4								350
	SR3	SAE 100R3 / EN 854 R3			1250	1200	1125	1000		750
Low Pressure Push-On	IG	Insta-Grip™ 300 (Non-Conductive)			300	300	300	300	300	300
	IGHT	Insta-Grip™ HT 300 (High Temperature)			300		300	300	300	300
	IGTC	Insta-Grip™ TC			300	300	300	300	300	300
	FXG	FLEXAGrip™		400	400		400	400	400	400
Medium Pressure	SR1SN	SAE 100R1AT / 1SN		3625	3260	3120	2615	2320	1890	1530
	Desert® DR1SN	SAE 100R1AT / 1SN (High Temperature)			3270		2615	2320	1890	1530
	SFS	SAE 100R1AT (Fire Suppression)			2750		2250	2000		1250
High Pressure	SR2SN	SAE 100R2AT / 2SN		6000	5800		4800	4000	3630	3120
	Desert® DR2SN	SAE 100R2AT / 2SN (High Temperature)			5800		4800	4000	3630	3120
	XR16SC	SAE 100R16 / EN 857 2SC			5800		5000	5000	4000	3500
	Arctic® LR2SN	SAE 100R2AT / 2SN (Low Temperature)			5000		4800	4000	3630	3120
	Arctic® LR16SC	SAE 100R16 / EN 857 2SC			5800		5000	4500	4000	3500
	DR16SC	SAE 100R16 / EN 857 2SC			5075		5000	4500	4000	3500
	SR16SC	SAE 100R16 / EN 857 2SC			5800		5000	5000	4000	3500
	Armorcoat™ ARC16SC	SAE 100R16 / EN 857 2SC (Abrasion Cover)			5800		5000	5000	4350	3500
	XCP3	SAE 100R17 (Constant Pressure)			3250		3250	3250	3250	3250
	SCP3	SAE 100R17 (Constant Pressure)			3045		3045	3045	3045	3045
	Armorcoat™ ACP3	SAE 100R17 (Abrasion Cover)			3250		3250	3250	3250	

HOSE

General Information

Working Pressure Selection Guide

Hose Working Pressure Selection Guide

Pressure Range	Family Part #	Hose Description	Dash Size									
			14	16	20	24	32	40	48	56	64	
			Hose ID									
			7/8" UT, AC: 3/4"	1" R5, UT: 7/8"	1 1/4" R5, UT: 1 1/8"	1 1/2" R5: 1 3/8"	2" R5: 1 13/16"	2 1/2"	3"	3 1/2"	4"	
Low Pressure	SR6	SAE 100R6 / EN 854 R6										
	HR6	SAE 100R6 / EN 854 R6 (High Temperature)										
	HR4	SAE 100R4		325	250	225	225	140	135			100
	SR3	SAE 100R3 / EN 854 R3		565	377				58			
Low Pressure Push-On	IG	Insta-Grip™ 300 (Non-Conductive)		300								
	IGHT	Insta-Grip™ HT 300 (High Temperature)										
	IGTC	Insta-Grip™ TC										
	FXG	FLEXAGrip™		400								
Medium Pressure	SR1SN	SAE 100R1AT / 1SN		1280	920	730	580					
	Desert® DR1SN	SAE 100R1AT / 1SN (High Temperature)		1280	920	730	580					
	SFS	SAE 100R1AT (Fire Suppression)		1000								
High Pressure	SR2SN	SAE 100R2AT / 2SN		2400	1820	1310	1160					
	Desert® DR2SN	SAE 100R2AT / 2SN (High Temperature)		2400								
	XR16SC	SAE 100R16 / EN 857 2SC		3000	2250							
	Arctic® LR2SN	SAE 100R2AT / 2SN (Low Temperature)		2400	1820		1160					
	Arctic® LR16SC	SAE 100R16 / EN 857 2SC		3000								
	DR16SC	SAE 100R16 / EN 857 2SC		3000								
	SR16SC	SAE 100R16 / EN 857 2SC		3000	1813							
	Armorcoat™ ARC16SC	SAE 100R16 / EN 857 2SC (Abrasion Cover)		3000								
	XCP3	SAE 100R17 (Constant Pressure)		3250								
	SCP3	SAE 100R17 (Constant Pressure)		3045								
	Armorcoat™ ACP3	SAE 100R17 (Abrasion Cover)										

Hose Working Pressure Selection Guide

Pressure Range	Family Part #	Hose Description	Dash Size								
			02	03	04	05	06	08	10	12	
			Hose ID								
			1/8"	3/16"	1/4" R5, UT: 3/16"	5/16" R5, UT: 1/4"	3/8" R5: 5/16"	1/2" R5, UT, AC: 13/32"	5/8" R5, UT, AC: 1/2"	3/4" R5, UT, AC: 5/8"	
Very High Pressure	XCP4	SAE 100R19 / ISO 11237			4060		4060	4060	4060	4060	
	XCP3S	SAE 100R12									
	XCP4S	SAE 100R12 / EN 856 4SH					4100	4100	4100	4100	
	XCP5S	SAE 100R13					5100	5100	5100	5100	
	XCP6S	SAE 100R15 / EN 856 4SP					6100	6100	6100	6100	
	SR12	SAE 100R12 / EN 856 R12					4100	4100	4100	4100	
	Armorcoat™ ARC12	SAE 100R12 / EN 856 R12 (Abrasion Cover)					4100	4100	4100	4100	
	SR13	SAE 100R13 / EN 856 R13								5100	
	ARC13	SAE 100R13 / EN 856 R13 (Abrasion Cover)						6100		6100	
	SR15	SAE 100R15						6100		6100	
	Armorcoat™ ARC15	SAE 100R15 (Abrasion Cover)						6100		6100	
	S4SP	EN 856 4SP						6455	6020	5075	5510
	S4SH	EN 856 4SH									6090
Thermo-plastic	SR7	SAE 100R7 / EN 855 R7	2500	3000	3000	2500	2250	2000		1250	
	TR7	SAE 100R7 (Twin-Line)		3000	3000	2500	2250	2000			
	NR7	SAE 100R7 (Non-Conductive)	2500	3000	2750	2500	2250	2250		1250	
	BR7	SAE 100R7 (Twin-Line, Non-Conductive)			2750	2500	2250	2250			
	SR8	SAE 100R8 / EN 855 R8		5000	5000		4000	3500			
	TR8	SAE 100R8 (Twin-Line)					4000	3500			
	NR8	SAE 100R8 (Non-Conductive)			5000		4000	3500			
	SR18	SAE 100R18			3000	3000	3000	3000			

Hose Working Pressure Selection Guide

Pressure Range	Family Part #	Hose Description	Dash Size								
			14	16	20	24	32	40	48	56	64
			Hose ID								
			7/8" UT, AC: 3/4"	1" R5, UT: 7/8"	1 1/4" R5, UT: 1 1/8"	1 1/2" R5: 1 3/8"	2" R5: 1 9/16"	2 1/2"	3"	3 1/2"	4"
Very High Pressure	XCP4	SAE 100R19 / ISO 11237									
	XCP3S	SAE 100R12			3100	3100	3100				
	XCP4S	SAE 100R12 / EN 856 4SH		4100	4100	4100	4100				
	XCP5S	SAE 100R13		5100	5100	5100	5100				
	XCP6S	SAE 100R15 / EN 856 4SP		6100	6100	6100	6100				
	SR12	SAE 100R12 / EN 856 R12		4100	3050	2550	2550				
	Armorcoat™ ARC12	SAE 100R12 / EN 856 R12 (Abrasion Cover)		4100	3050	2550	2550				
	SR13	SAE 100R13 / EN 856 R13		5100	5100	5100	5100				
	Armorcoat™ ARC13	SAE 100R13 / EN 856 R13 (Abrasion Cover)		5100	5100	5100	5100				
	SR15	SAE 100R15		6100	6100	6100					
	Armorcoat™ ARC15	SAE 100R15 (Abrasion Cover)		6100							
	S4SP	EN 856 4SP		4640							
	S4SH	EN 856 4SH		5510	5080	4025	3650				
Thermo-plastic	SR7	SAE 100R7 / EN 855 R7		1000							
	TR7	SAE 100R7 (Twin-Line)									
	NR7	SAE 100R7 (Non-Conductive)		1000							
	BR7	SAE 100R7 (Twin-Line, Non-Conductive)									
	SR8	SAE 100R8 / EN 855 R8									
	TR8	SAE 100R8 (Twin-Line)									
	NR8	SAE 100R8 (Non-Conductive)									
	SR18	SAE 100R18									

Hose Working Pressure Selection Guide

Pressure Range	Family Part #	Hose Description	Dash Size							
			02	03	04	05	06	08	10	12
			Hose ID							
			1/8"	3/16"	1/4" R5, UT: 3/16"	5/16" R5, UT: 1/4"	3/8" R5: 5/16"	1/2" R5, UT, AC: 13/32"	5/8" R5, UT, AC: 1/2"	3/4" R5, UT, AC: 5/8"
Special Application	NSFX	Saflex® (Non-Conductive)			2750		2250	2000		
	BOP	Prospector™ BOP (Blowout Preventor)					3000 / 5000	3000 / 5000		3000 / 5000
	SGUN	Grease Gun Hose		3000						
	SHJ	Jack Hose			10000		10000			
	Hot Oiler	Prospector™ Hot Oiler								
Fleet Application	SR14A	SAE 100R14A		3000	3000	2500	2250	1500	1200	1100
	SR5	SAE 100R5			3000	3000	2250	2000	1750	1500
	Desert® DR5	SAE 100R5 (High Temperature)			3000	3000	2250	2000	1750	1500
	Desert® DUT	Universal Truck			2000	1500	1500	1250	1000	750
Air Conditioning	G4826	SAE J2064 Type C Class II					500	500	500	350
	G4867	SAE J2064 Type C Class II								
	G4890	SAE J2064 Type C Class I					500	500	500	350
Military Application	MIL-DTL-13444H-I	MIL-DTL-13444 Type I		425	300	275	250	200	175	125
	MIL-DTL-13444H-III	MIL-DTL-13444 Type III			1500	1500	1000	1000	875	750
	MIL-DTL-13531	MIL-DTL-13531 Type II Class A		5000	5000	4250	4000	3500	2750	2250
	MIL-DTL-39921	MIL-DTL-39921 Type I Class I					200		200	
	MIL-DTL-8788	MIL-DTL-8788			3000	3000	3000	3000	3000	3000

HOSE



General Information

Working Pressure Selection Guide

Hose Working Pressure Selection Guide

Pressure Range	Family Part #	Hose Description	Dash Size								
			14	16	20	24	32	40	48	56	64
			Hose ID								
			7/8"	1"	1 1/4"	1 1/2"	2"	2 1/2"	3"	3 1/2"	4"
			UT, AC: 3/4"	R5, UT: 7/8"	R5, UT: 1 1/8"	R5: 1 3/8"	R5: 1 13/16"				
Special Application	NSFX	Saflex® (Non-Conductive)									
	BOP	Prospector™ BOP (Blowout Preventor)		3000 / 5000	5000	5000	5000				
	SGUN	Grease Gun Hose									
	SHJ	Jack Hose									
	Hot Oiler	Prospector™ Hot Oiler				2500					
Fleet Application	SR14A	SAE 100R14A		900							
	SR5	SAE 100R5		800	625	500	350				
	Desert® DR5	SAE 100R5 (High Temperature)		800	625	500	350				
	Desert® DUT	Universal Truck		400	300						
Air Conditioning	G4826	SAE J2064 Type C Class II									
	G4867	SAE J2064 Type C Class II	350								
	G4890	SAE J2064 Type C Class I									
Military Application	MIL-DTL-13444H-I	MIL-DTL-13444 Type I									
	MIL-DTL-13444H-III	MIL-DTL-13444 Type III			375	300					
	MIL-DTL-13531	MIL-DTL-13531 Type II Class A		2000	2000						
	MIL-DTL-39921	MIL-DTL-39921 Type I Class I									
	MIL-DTL-8788	MIL-DTL-8788			3000						

Hydraulic Hose Special Attributes

Family Part #	Hose Description	Meets Flame Resistance USMSHA	Meets Higher DIN / EN Pressure	USCG Approved	ABS Approved	High Temp Hose	Low Temp Hose	Abrasion Cover Hose	Twin-Line Hose	Non-Conductive Hose	Fire Tested	SAE J1402 / DOT
SR1SN	SAE 100R1AT / 1SN											
Desert® DR1SN	SAE 100R1AT / 1SN			≤ 1	Pending							
SFS	SAE 100R1AT / 1SN (Fire Suppression)											
SR2SN	SAE 100R2AT / 2SN				-4 to -16							
Arctic® LR2SN	SAE 100R2AT / 2SN											
Arctic® LR16SC	SAE 100R16 / EN 857 2SC											
Desert® DR16SC	SAE 100R16 / EN 857 2SC											
Desert® DR2SN	SAE 100R2AT / 2SN				Pending							
SR3	SAE 100R3 / EN 854 R3											
HR4	SAE 100R4											
SR5	SAE 100R5											
Desert® DR5	SAE 100R5											
Desert® DUT	SAE J1402 A1 (Universal Truck)											
SR6	SAE 100R6 / EN 854 R6											
HR6	SAE 100R6 / EN 854 R6											
SR7	SAE 100R7 / EN 855 R7											
NR7	SAE 100R7 (Non-Conductive)											
NSFX	Saflex® (Non-Conductive)											
TR7	SAE 100R7 (Twin-Line)											
BR7	SAE 100R7 (Twin-Line, Non-Conductive)											
SR8	SAE 100R8 / EN 855 R8											

Hydraulic Hose Special Attributes

Family Part #	Hose Description	Meets Flame Resistance USMSHA	Meets Higher DIN / EN Pressure	USCG Approved	ABS Approved	High Temp Hose	Low Temp Hose	Abrasion Cover Hose	Twin-Line Hose	Non-Conductive Hose	Fire Tested	SAE J1402 / DOT
NR8	SAE 100R8 (Non-Conductive)											
TR8	SAE 100R8 (Twin-Line)											
S4SH	EN 856 4SH / DIN 20023 4SH				Pending							
S4SP	EN 856 4SP / DIN 20023 4SP				Pending							
XCP4	SAE 100R19 / ISO 11237 R19											
SR12	SAE 100R12 / EN 856 R12				Pending							
Armorcoat™ ARC12	SAE 100R12 / EN 856 R12											
SR13	SAE 100R13 / EN 856 R13				Pending							
Armorcoat™ ARC13	SAE 100R13 / EN 856 R13											
SR14A	SAE 100R14A											
SR15	SAE 100R15			Pending	Pending							
Armorcoat™ ARC15	SAE 100R15											
SR16SC	SAE 100R16 / EN 857 2SC											
XR16SC	SAE 100R16 / EN 857 2SC											
Armorcoat™ ARC16SC	SAE 100R16 / EN 857 2SC											
SCP3	SAE 100R17											
Armorcoat™ ACP3	SAE 100R17											
XCP3	SAE 100R17											
XCP3S	SAE 100R12											
XCP4S	SAE 100R12 / EN 856 4SH											
XCP5S	SAE 100R13											
XCP6S	SAE 100R15 / EN 856 4SP											

Hydraulic Hose Special Attributes

Family Part #	Hose Description	Meets Flame Resistance USMSHA	Meets Higher DIN / EN Pressure	USCG Approved	ABS Approved	High Temp Hose	Low Temp Hose	Abrasion Cover Hose	Twin-Line Hose	Non-Conductive Hose	Fire Tested	SAE J1402 / DOT
SR18	SAE 100R18											
BOP	Prospector™ BOP (Blowout Preventor)											
SGUN	Grease Gun Hose											
SHJ	Jack Hose											
IG	Insta-Grip™ 300 (Push-On)											
IGHT	Insta-Grip™ HT 300 (Push-On, High Temp)											
IGTC	Insta-Grip™ TC (Push-On, Textile Cover)											
FXG	FLEXAGrip™ (Push-On)											
MIL-DTL-13444H-I	MIL-DTL-13444H Type I (Military)											
MIL-DTL-13444H-III	MIL-DTL-13444H Type III (Military)											
MIL-DTL-13531-BA	MIL-DTL-13531 Type II Class A (Military)											
MIL-DTL-39921	MIL-DTL-39921 Type I Class I (Military)											
MIL-DTL-8788	MIL-DTL-8788 (Military)											

Hydraulic Hose Temperature Limits

A	SR14A	SAE 100R14A*
B	Desert® DR5	SAE 100R5 / DOT FMVSS 106 All**
	Desert® DUT	Universal Truck
	IGHT	Insta-Grip™ HT 300
	Desert® DR1SN	SAE 100R1AT/1SN
C	HR4	SAE 100R4
	HR6	SAE 100R6 / EN 854 R6
	SR12	SAE 100R12 / EN 856 R12
D	ARC12	Armorcoat™ SAE 100R12 / EN 856 R12
	SR13	SAE 100R13 / EN 854 R13
	ARC13	Armorcoat™ SAE 100R13 / EN 856 R13
	SR15	SAE 100R15
	ARC15	Armorcoat™ SAE 100R15
	BOP 5000	Prospector™ BOP 5000
E	Arctic® LR2SN	SAE 100R2AT/2SN
F	SFS	SAE 100R1AT Fire Suppression
	SR1SN	SAE 100R1AT/1SN
	SR2SN	SAE 100R2AT/2SN
	SR3	SAE 100R3 / EN 854 R3
	SR5	SAE 100R5 / DOT FMVSS 106 All
	SR6	SAE 100R6 / EN 854 R6
	NSFX	Saflex® Non-Conductive
	S4SH	EN 856 4SH / DIN 20023 4SH
	S4SP	EN 856 4SP / DIN 20023 4SP
	SR16SC	SAE 100R16 / EN 857 2SC
	XR16SC	SAE / EN 857 2SC
	ARC16SC	Armorcoat™ SAE 100R16 / EN 857 2SC
	SCP3	SAE 100R17
	XCP3	SAE 100R17 Constant Pressure
ACP3	Armorcoat™ SAE 100R17	
XCP4	SAE 100R19 / ISO 11237	
SGUN	Grease Gun Hose	
SHJ	Jack Hose	
BOP 3000	Prospector™ BOP 3000	
G	SR7	SAE 100R7 / EN 855 R7
	TR7	SAE 100R7 Twin-Line
	SR8	SAE 100R8 / EN 858 R8
	TR8	SAE 100R8 Twin-Line
	NR8	SAE 100R8 Non-Conductive
H	IGTC	Insta-Grip™ TC
	FXG	FLEXAGrip™
	NR7	SAE 100R7 Non-Conductive
I	BR7	SAE 100R7 Twin-Line, Non-Conductive
	SR18	SAE 100R18
J	MIL-8788	
K	MIL-13531	
L	MIL-3992	
M	MIL-13444-I	
N	MIL-13444-III	

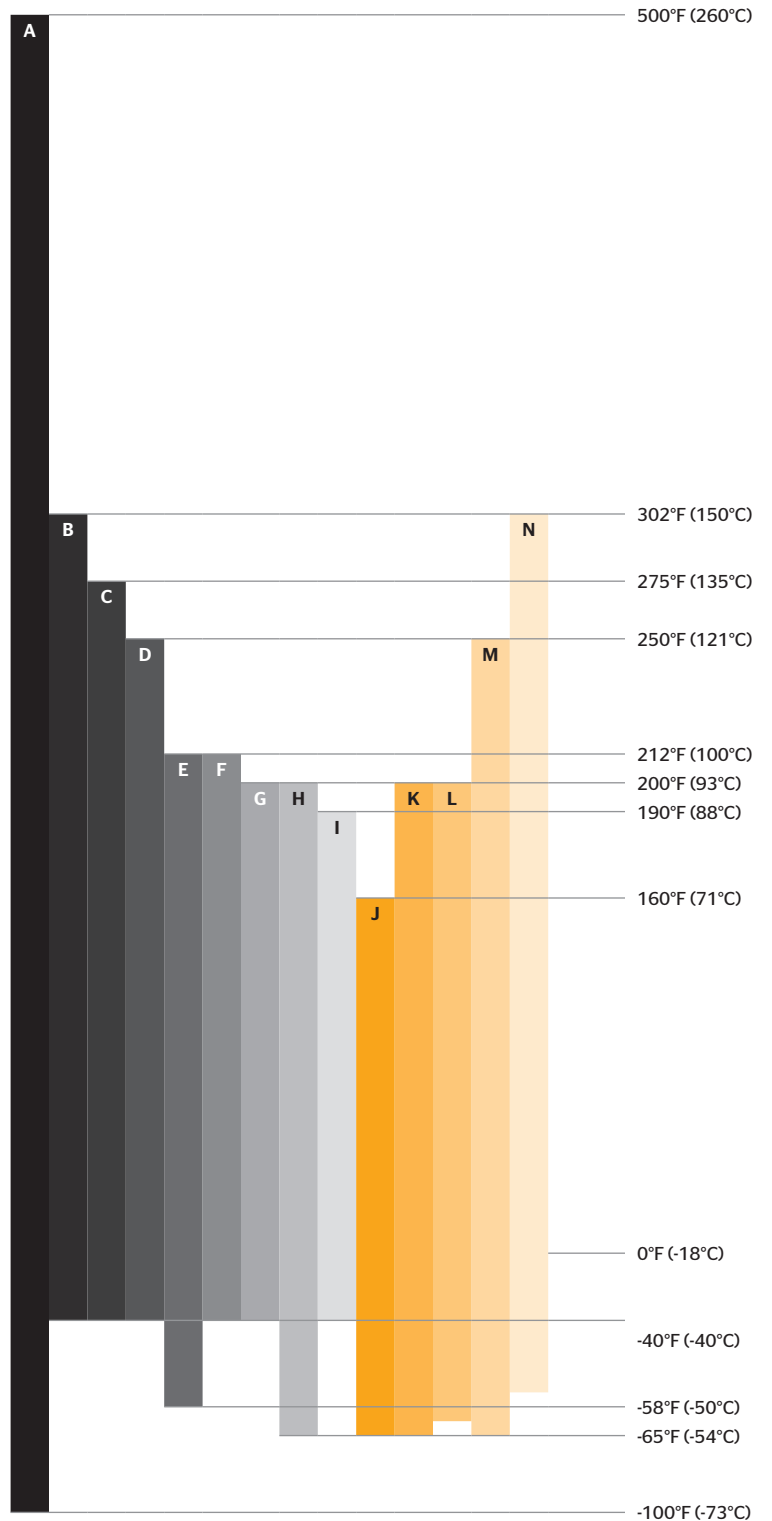

*Intermittent Service

**Hot Oil/Hydraulic Application

General Information
Temperature Limits



Hose Accessories

Protective Sleeving

Protective sleeves extend hose life by protecting hose covers from abrasion typically found in industries such as agricultural, logging, construction and mining. Protective sleeving can also be useful in bundling hose assemblies, making it easier to handle multiple hose.



FEATURES + SPECS

Abrasion-resistant

MSHA Approved

Good resistance to sun, atmospheric agents and aging

Temperature Range

-40°F to 340°F (-40°C to 171.1°C)

Material

Polyamide 6 (nylon)

Color

Black

Available Lengths

Continuous 100' rolls

Descriptive Number	Product Number	SAP Number	ID	Flat Width	Weight
			in.	in.	lbs./ft.
GTEXS20	60200-0020	20243598	0.79	1.34	.02
GTEXS25	60200-0025	20243599	0.98	1.65	.03
GTEXS27	60200-0027	20243600	1.06	1.77	.03
GTEXS31	60200-0031	20243601	1.22	2.05	.04
GTEXS36	60200-0036	20243602	1.42	2.24	.04
GTEXS40	60200-0040	20243603	1.57	2.60	.05
GTEXS44	60200-0044	20243604	1.73	2.83	.06
GTEXS55	60200-0055	20243605	2.17	3.50	.07

Protective Wrap

Protective wrap extends hose life by offering resistance to kinking and cover abrasion. A protective wrap may also be used for the bundling of hose lines for easier handling.



FEATURES + SPECS

Can be installed without disconnecting hose

Can be overlapped for greater protection

Lightweight

Temperature Range

-30°F to 185°F (-34°C to 85°C)

Material

Cellulose acetate (thermoplastic)

Color

Black

Available Lengths

Continuous 66' rolls

Descriptive Number	Product Number	SAP Number	ID	Flat Width	Weight
			in.	in.	lbs./ft.
HWRAP-12	60210-0012	20243592	0.50	.07	.05
HWRAP-16	60210-0016	20243593	0.63	.07	.06
HWRAP-19	60210-0019	20243594	0.75	.09	.08
HWRAP-25	60210-0025	20243595	1.00	.09	.12
HWRAP-35	60210-0035	20243596	1.38	.09	.17
HWRAP-47	60210-0047	20243597	1.85	.15	.28

Extruded spiral will have +/- 4% variation in thickness and weight.

HOSE

Continental

Hose Accessories

Protective Sleeving / Protective Wrap

Hose Accessories

Hose Routing Clamps

Routing clamps can be used for support for long hose lengths. They also aid proper hose routing where abrasion or heat exists.



FEATURES + SPECS

Material

Steel with 1/32" thick black vinyl cushion

Descriptive Number	Product Number	SAP Number	Clamping Diameter	Bolt Hole
			in.	in.
HRC-0413	60300-0413	20539632	3/16	1/4
HRC-0509	60300-0509	20539633	1/4	9/32
HRC-0709	60300-0709	20431807	3/8	9/32
HRC-0809	60300-0809	20431808	7/16	9/32
HRC-0913	60300-0913	20431809	1/2	13/32
HRC-1013	60300-1013	20431810	9/16	13/32
HRC-1113	60300-1113	20431811	5/8	13/32
HRC-1213	60300-1213	20431812	11/16	13/32
HRC-1313	60300-1313	20431813	3/4	13/32
HRC-1413	60300-1413	20431814	13/16	13/32
HRC-1513	60300-1513	20431815	7/8	13/32
HRC-1613	60300-1613	20431816	15/16	13/32
HRC-1713	60300-1713	20431817	1	13/32
HRC-1813	60300-1813	20431818	1 1/16	13/32
HRC-1913	60300-1913	20431819	1 1/8	13/32
HRC-2017	60300-2017	20431820	1 3/16	17/32
HRC-2117	60300-2117	20431821	1 1/4	17/32
HRC-2317	60300-2317	20431822	1 3/8	17/32
HRC-2517	60300-2517	20431823	1 1/2	17/32
HRC-2617	60300-2617	20431824	1 5/16	17/32
HRC-2917	60300-2917	20431825	1 3/4	17/32
HRC-3117	60300-3117	20431826	1 7/8	17/32
HRC-3217	60300-3217	20431827	1 15/16	17/32
HRC-3317	60300-3317	20431828	2	17/32
HRC-3417	60300-3417	20431829	2 1/32	17/32
HRC-3817	60300-3817	20431830	2 1/2	17/32

FITTINGS



Hydraulic Fitting Families

The Continental fitting product line is broken into sections based on the fitting type:

1	2	3	4	5	6	7	8	9	10	11
B2	SG	S6, DG	BT	UC	FG	TP	AC	UT	Specialty	Ferrules
SR1SN	SR12	SR13	HR4	SR1SN	SR5	SR7	G4826	DUT	NSFX	SR1SN
DR1SN	ARC12	ARC13		SR2SN	DR5	TR7	G4867		Hot Oiler	SR2SN
SFS	SR13	SR15		SR3		NR7	G4890		SGUN	SR3
SR2SN	ARC13	ARC15		SR5		BR7			SHJ	SR5
DR2SN	SR15	S4SP		DR5		SR8			IG	DR5
LR2SN	ARC15	S4SH		SR6		TR8			IGHT	SR6
LR16SC	S4SP			HR6		NR8			IGTC	HR6
SR16SC	S4SH			HR4		SR18			FXG	HR4
ARC16SC	XCP3S			SR14A						SR14A
DR16SC	XCP4S			SFS						SFS
XR16SC	XCP5S			SCP3						SCP3
SCP3	XCP6S			ACP3						ACP3
ACP3				BOP						BOP
XCP3										SR13
XCP4										ARC13
SR12										SR15
ARC12										S4SP
Hot Oiler										S4SH
										XCP6S

Quick-Find™ Fittings

Continental Brand Quick-Find™ Hydraulic Hose and Fitting catalog makes fitting selection very easy with a 5-step process.

Step 1 - Choose the Hose Type

The first step in choosing the correct fitting is selecting the hose type from one of the 10 sections (excluding ferrules).

Note: Some hose may appear in more than one section, depending on the hose dash size and/or whether the desired fitting solution is a one-piece (B2, BT, SG, S6), two-piece (UC, DG) or re-attachable (FG).

Step 2 - Choose the Fitting Description

Once the hose type has been identified, go to the correct section and view the available fittings for that particular hose. Within the content of each section there is a table for each fitting.

The Fitting Description at the top of each table describes the following elements:

JIC 37° Flare (SAE J514)	Female	45° Elbow	Swivel
Thread Description	Gender	Elbow	Swivel or Non-Swivel

Step 3 - Choose Hose ID and Thread Size

Choose the correct fitting selected in Step 2 based on the Hose ID and Thread Size. In some cases, a fitting may be available in several thread sizes. As an example, a JIC 37° Flare (SAE J514) Female Swivel is available for a Hose ID of 3/8" and thread sizes 9/16 -18 and 3/4 -16.

Step 4 - Determine Availability for Hose Type

With the desired fitting identified by hose ID and thread size in Step 3, confirm the fitting is compatible for a particular hose type by referencing the hose listed in the footer shown on the bottom of the page.

Step 5 - Note the Part Number

The fitting part number can now be noted. The part number is found on the left side of the chart. For UC and DG two-piece fittings, see Section 11 - Ferrules to find the appropriate ferrule.



Download the **MyCrimp App** for more information.

General Information

Fitting Selection

FITTINGS



Hydraulic Fittings Nomenclature

EXAMPLE: **B2 - JCFX45 - 0608**

FITTING FAMILY	THREAD DESCRIPTION	HOSE DASH SIZE	THREAD DASH SIZE
First 2 Characters	Next 2-7 Characters	Next 2 Characters	Last 2 Characters
B2 BT Ultra-Crimp™ S6 (1-piece fitting) SG	Refer to the next page for detailed information. For AC and GC fittings, see Section 8 (starting on page 303).	All hose except SAE 100R5, DUT and Galaxy Hose: 02 1/8" (32 mm) 03 3/16" (4.8 mm) 04 1/4" (6.4 mm) 05 5/16" (7.9 mm) 06 3/8" (9.5 mm) 08 1/2" (12.7 mm) 10 5/8" (15.9 mm) 12 3/4" (19 mm) 16 1" (25.4 mm) 20 1 1/4" (31.8 mm) 24 1 1/2" (38.1 mm) 32 2" (50.8 mm) 40 2 1/2" (63.5 mm)	See the Thread Reference Chart for converting dash size to thread sizes (starting on page 390). 02 03 04 05 06 08 10 12 14 15 16 18 20 22 24 26 28 30 32 33 36 40 42 45 52
T7 Thermoplastic T8 (1-piece fitting)			
FG Field-Grip™ (1-piece reattachable fitting)			
UT DUT Hose (1-piece reattachable fitting)			
UC Uni-Crimp™ Stem (2-piece fitting)			
DG Dual-Grip Stem (2-piece internal and external skive fitting)			
PB Push-On Brass (1-piece fitting)		SAE 100R5, DUT and Galaxy Hose:	
SF Saflex® (1-piece fitting)		04 3/16" (4.8 mm) 05 1/4" (6.4 mm) 06 5/16" (7.9 mm) 08 13/32" (10.3 mm) 10 1/2" (12.7 mm) 12 5/8" (15.9 mm) 14 3/4" (19.1 mm) 16 7/8" (22.2 mm) 20 1 1/8" (28.6 mm) 24 1 3/8" (35 mm) 32 1 13/16" (46 mm)	
GG Grease Gun (1-piece fitting)			
AC Air Conditioning (1-piece crimp fitting)			
GC Cool Clip® (air conditioning clip fitting)			

Warning - Selection of Fitting

Selection of the proper fittings for the application is essential to the proper operation and safe use of the hose and related equipment. Inadequate attention to the selection of the hose fitting for the application can result in hose leakage, bursting or other failures, which can cause serious bodily injury or property damage from spraying fluids or flying projectiles. Some of the factors involved in the selection of the proper hose ends are:

› **Fluid Compatibility** › **Pressure** › **Temperature** › **Installation Design** › **Hose Size** › **Corrosion Requirements**

If there are any questions as to what fitting should be used, Continental recommends that you consult the Continental Hydraulics Application Group for assistance.

Proper Assembly of Continental Hose and Fittings

Continental hose, fittings and crimping equipment work together to provide an efficient and reliable hose connection. Continental hose and fittings are part of an engineered system and are to be assembled in accordance with Continental specifications. Using non-Continental components may produce an assembly that does not meet rated performance. Continental DOES NOT WARRANT, EXPRESSLY OR BY IMPLICATION, HOSE ASSEMBLIES THAT DO NOT INCORPORATE Continental HOSE AND FITTINGS, OR ARE NOT CRIMPED IN ACCORDANCE WITH Continental's PROCESS SPECIFICATIONS.

Buyers may elect to attach additional or non-standard parts or equipment, or to use different manufacturing specifications, as necessary to meet the requirements of the buyer or customer's application. In such cases, the buyer has sole responsibility to qualify the hose for these applications as necessary to ensure performance capability.

For guidance in the assembly of Continental hose and couplings, please refer to the Continental Crimp Specifications Manual. Information in this catalog is believed to be accurate, but is not warranted, and is subject to change without prior notice.

For the most current available product information, check www.contitech.us.

Hydraulic Fittings Nomenclature

Thread	Thread Description	Gender	Swivel	Elbow	Thread	Thread Description	Gender	Swivel	Elbow
JC FX		Female	Swivel		OF FX		Female	Swivel	
JC FX45		Female	Swivel	45° Elbow	OF FX45		Female	Swivel	45° Elbow
JC FX90		Female	Swivel	90° Elbow	OF FX90		Female	Swivel	90° Elbow
JC FX90L	JIC 37° Flare (SAE J514)	Female	Swivel	90° Elbow (Long Drop-Tube)	OF FX90L	O-Ring Face Seal (SAE J1453 ORS/ORFS)	Female	Swivel	90° Elbow (Long Drop-Tube)
JC FX90S		Female	Swivel	90° Elbow (Short Drop-Tube)	OF FX90S		Female	Swivel	90° Elbow (Short Drop-Tube)
JC M		Male			OF M		Male		
SF FX		Female	Swivel		OB M		Male		
SF FX45		Female	Swivel	45° Elbow	OB MX	O-Ring Boss Straight Thread (SAE J514)	Male	Swivel	
SF FX90		Female	Swivel	90° Elbow	OB MX90B		Male	Swivel	90° Block Elbow
SF FX90L	SAE 45° J512 Flare	Female	Swivel	90° Elbow (Long Drop-Tube)	FL				
SF FX90S		Female	Swivel	90° Elbow (Short Drop-Tube)	FL 22				22.5° Elbow
SF M		Male			FL 30				30° Elbow
SI F		Female			FL 45				45° Elbow
SI M		Male			FL 60	Code 61 Flange (SAE J518)			60° Elbow
SI MX	SAE 45° Inverted Flare	Male	Swivel		FL 67				67° Elbow
SI MX45		Male	Swivel	45° Elbow	FL 90				90° Elbow
SI MX90		Male	Swivel	90° Elbow	FL 110				110° Elbow
NP F		Female			FL 135				135° Elbow
NP FX		Female	Swivel		FL 90EOC	Engine Oil Connection			90° Elbow
NP M		Male			FH				
NP M90	NPTF	Male		90° Elbow	FH 22				22.5° Elbow
NP MX		Male	Swivel		FH 30				30° Elbow
NP MX90B		Male	Swivel	90° Block Elbow	FH 45	Code 62 Flange (SAE J518)			45° Elbow
NP MAPI	NPTF Oil Field Connection	Male			FH 60				60° Elbow
HM	Hose Mender				FH 67				67° Elbow
NS FX	NPSM	Female	Swivel		FH 90				90° Elbow
FT M	SAE J514 Flareless Tube Fittings	Male			CF				
GT F	Grease Trap	Female			CF 22				22.5° Elbow
SP	Standpipe				CF 30				30° Elbow
SP 45				45° Elbow	CF 45	Caterpillar® Flange			45° Elbow
					CF 60				60° Elbow
					CF 67				67° Elbow
					CF 90				90° Elbow

Continued on the next page.



Download the **MyCrimp App** for more information.

General Information
Hydraulic Fittings Nomenclature

FITTINGS



Hydraulic Fittings Nomenclature Continued

Thread	Thread Description	Gender	Swivel	Elbow
KF				
KF 45	Komatsu Flange			45° Elbow
KF 90				90° Elbow
BP	BSPP (British Standard Pipe Parallel)	Female	Swivel	
BP		Female	Swivel	45° Elbow
BP		Female	Swivel	90° Elbow
BP		Male	Swivel	
BT M	BSPT (British Standard Pipe Tapered)	Male		
BF FX	BSP Flat Seat (British Standard Pipe)	Female	Swivel	
DL FX	DIN 24° Light	Female	Swivel	
DL FX45		Female	Swivel	45° Elbow
DL FX90		Female	Swivel	90° Elbow
DL M		Male		

Thread	Thread Description	Gender	Swivel	Elbow
DH FX	DIN 24° Heavy	Female	Swivel	
DH FX45		Female	Swivel	45° Elbow
DH FX90		Female	Swivel	90° Elbow
DH M		Male		
DN FX45	DIN 60	Female	Swivel	45° Elbow
DN FX90		Female	Swivel	90° Elbow
KM	Komatsu 30° Flare (Metric Threads)	Female	Swivel	
KM		Female	Swivel	45° Elbow
KM		Female	Swivel	90° Elbow
JS FX	JIS 30° (Parallel Pipe Thread)	Female	Swivel	
PTT FX	PTT 30° (for DUT hose)	Female	Swivel	

Hydraulic Ferrule Nomenclature

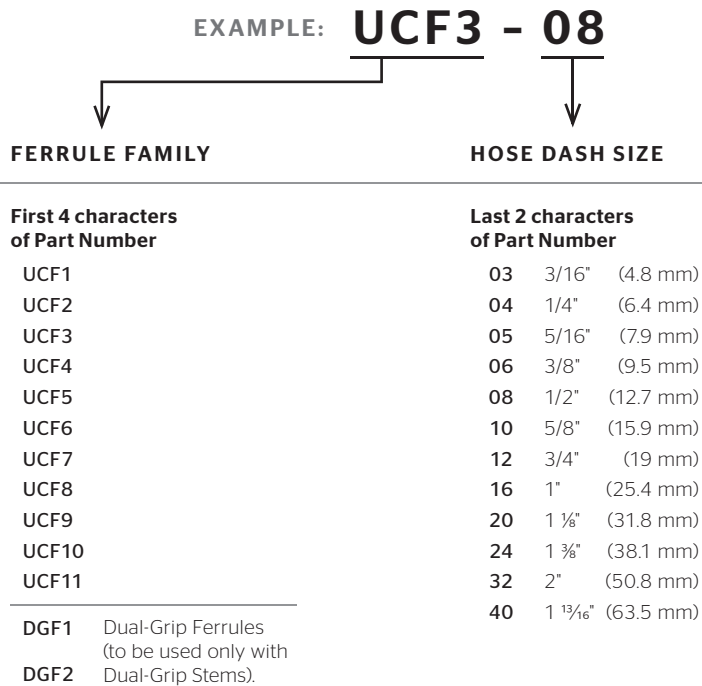

SECTION 1 - B2 FITTINGS

This section lists all fittings compatible with the following hose:

Hose	Description	Compatible Dash Size	Hose	Description	Compatible Dash Size
SR1SN	SAE 100R1AT / EN 853 1SN	All hose dash sizes	DR16SC	SAE 100R16 / EN 857 2SC	All hose dash sizes
DR1SN	SAE 100R1AT / EN 853 1SN	All hose dash sizes	XR16SC	SAE 100R16 / EN 857 2SC	All hose dash sizes
SFS	Fire Suppression	All hose dash sizes	SCP3	SAE 100R17	All hose dash sizes
SR2SN	SAE 100R2AT / EN 856 2SN	All hose dash sizes	ACP3	SAE 100R17	All hose dash sizes
DR2SN	SAE 100R2AT / EN 853 2SN	All hose dash sizes	XCP3	SAE 100R17	All hose dash sizes
LR2SN	SAE 100R2AT / EN 856 2SN	All hose dash sizes	XCP4	SAE 100R19 / ISO 11237	All hose dash sizes
LR16SC	SAE 100R16 / EN 857 2SC	All hose dash sizes	ACP4	SAE 100R19	All hose dash sizes
SR16SC	SAE 100R16 / EN 857 2SC	All hose dash sizes	SR12	SAE 100R12 / EN 856 R12	Hose dash sizes below -24
ARC16SC	SAE 100R16 / EN 857 2SC	All hose dash sizes	ARC12	SAE 100R12 / EN 856 R12	Hose dash sizes below -24

How to Use the Fittings Table





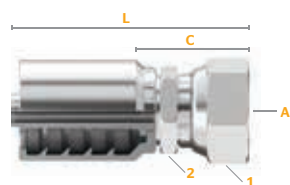

The fittings in this section will follow a similar table structure to the one seen on this page.

Fitting dimensions and attributes are explained below.



Fitting Name

Fitting Description

Part Number	Product Number	SAP Number						
			Hose ID	Thread Size (A)	Hex 1 Wrench Size	Hex 2 Wrench Size	Cut-Off (C)	Length (L)
B2-JCFX-0404	14400-0404	20242031	in.	7/16-20	in.	mm	in.	mm
B2-JCFX-0606	14400-0606	20242041	3/8	9/16-18	3/4	19	11/16	17
B2-JCFX-0808	14400-0808	20242008	1/2	3/4-16	1	25	3/4	19

Fitting Dimensions and Attributes

Part Number See Hydraulic Fittings Nomenclature on page 128 for a breakdown of part number attributes

Hose ID The compatible Hose ID

Tube ID The compatible Tube ID

Thread Size The thread size or sizes available for a particular fitting dash size (indicated by **A** in the fitting image)

Flange Size The flange size or sizes available for a particular fitting dash size (indicated by **A** in the fitting image)

Hex Size The wrench size for one or both nuts on the fitting (indicated by **1** or **2** in the fitting image)

Drop The length of the elbow (indicated by **D** in the fitting image)

Cut-Off The amount of hose to be cut for a correct assembly length (indicated by **C** in the fitting image)

Length The overall length of the fitting

Skive Type For applicable fittings, a skive type will be indicated as Skive, Non-Skive or Dual-Grip

Choose fittings carefully, considering the working pressure of both the hose and fitting. The maximum working pressure of the hose assembly is the lesser of the rated working pressure of the hose and the fitting. See page 389 for the Fittings Working Pressure Guide.



Download the **MyCrimp App** for more information.

Section 1
B2 Fittings

FITTINGS



B2 Fittings Overview

A complete overview of all B2 fittings found in this section.

<p>JIC 37° Flare (SAE J514) Female Swivel</p>  <p>B2-JCFX P. 135</p>	<p>JIC 37° Flare (SAE J514) Female 45° Elbow Swivel</p>  <p>B2-JCFX45 P. 136</p>	<p>JIC 37° Flare (SAE J514) Female 90° Elbow Swivel</p>  <p>B2-JCFX90 P. 137</p>	<p>JIC 37° Flare (SAE J514) Female 90° Block Elbow Swivel</p>  <p>B2-JCFX90B P. 139</p>
<p>JIC 37° Flare (SAE J514) Male</p>  <p>B2-JCM P. 139</p>	<p>SAE 45° J512 Flare Female Swivel</p>  <p>B2-SFFX P. 140</p>	<p>SAE 45° J512 Flare Female 45° Elbow Swivel</p>  <p>B2-SFFX45 P. 141</p>	<p>SAE 45° J512 Flare Female 90° Elbow Swivel</p>  <p>B2-SFFX90 P. 141</p>
<p>SAE 45° J512 Flare Male</p>  <p>B2-SFM P. 142</p>	<p>SAE 45° Inverted Flare Male Swivel</p>  <p>B2-SIMX P. 142</p>	<p>SAE 45° Inverted Flare Male 45° Elbow Swivel</p>  <p>B2-SIMX45 P. 143</p>	<p>SAE 45° Inverted Flare Male 90° Elbow Swivel</p>  <p>B2-SIMX90 P. 143</p>
<p>NPTF Female</p>  <p>B2-NPF P. 144</p>	<p>NPTF Female Swivel</p>  <p>B2-NPFX P. 144</p>	<p>NPTF Male</p>  <p>B2-NPM P. 145</p>	<p>NPTF Male Swivel</p>  <p>B2-NPMX P. 146</p>
<p>NPTF Male 90° Block Elbow Swivel</p>  <p>B2-NPMX90B P. 147</p>	<p>NPSM Female Swivel</p>  <p>B2-NSFX P. 147</p>	<p>GTF Female</p>  <p>B2-GTF P. 148</p>	<p>SAE J514 Flareless Tube Fitting</p>  <p>B2-FTM P. 148</p>
<p>Standpipe</p>  <p>B2-SP P. 149</p>	<p>Standpipe 45° Elbow</p>  <p>B2-SP45 P. 149</p>	<p>O-Ring Face Seal (SAE J1453 ORS/ORFS) Female Swivel</p>  <p>B2-OFFX P. 150</p>	<p>O-Ring Face Seal (SAE J1453 ORS/ORFS) Female 45° Elbow Swivel</p>  <p>B2-OFFX45 P. 151</p>
<p>O-Ring Face Seal (SAE J1453 ORS/ORFS) Female 90° Elbow Swivel</p>  <p>B2-OFFX90 P. 152</p>	<p>O-Ring Face Seal (SAE J1453 ORS/ORFS) Male</p>  <p>B2-OFM P. 153</p>	<p>O-Ring Boss Straight Thread (SAE J514) Male</p>  <p>B2-OBM P. 154</p>	<p>O-Ring Boss Straight Thread (SAE J514) Male Swivel</p>  <p>B2-OBMX P. 155</p>





























COMPATIBLE HOSE:

SR1SN	SR2SN	LR16SC	DR16SC	ACP3	SR12
DR1SN	DR2SN	SR16SC	XR16SC	XCP3	ARC12
SFS	LR2SN	ARC16SC	SCP3	XCP4	Hot Oilier

For a detailed list, please refer to your Crimp Specifications Manual.

B2 Fittings Overview

A complete overview of all B2 fittings found in this section.

<p>O-Ring Boss Straight Thread (SAE J514) Male 90° Block Elbow Swivel</p>  <p>B2-OBMX90B P. 155</p>	<p>Code 61 Flange (SAE J518)</p>  <p>B2-FL P. 156</p>	<p>Code 61 Flange (SAE J518) 22.5° Elbow</p>  <p>B2-FL22 P. 156</p>	<p>Code 61 Flange (SAE J518) 30° Elbow</p>  <p>B2-FL30 P. 157</p>
<p>Code 61 Flange (SAE J518) 45° Elbow</p>  <p>B2-FL45 P. 157</p>	<p>Code 61 Flange (SAE J518) 60° Elbow</p>  <p>B2-FL60 P. 158</p>	<p>Code 61 Flange (SAE J518) 67° Elbow</p>  <p>B2-FL67 P. 158</p>	<p>Code 61 Flange (SAE J518) 90° Elbow</p>  <p>B2-FL90 P. 159</p>
<p>Code 61 Flange (SAE J518) 110° Elbow</p>  <p>B2-FL110 P. 159</p>	<p>Code 62 Flange (SAE J518)</p>  <p>B2-FH P. 160</p>	<p>Code 62 Flange (SAE J518) 22.5° Elbow</p>  <p>B2-FH22 P. 160</p>	<p>Code 62 Flange (SAE J518) 30° Elbow</p>  <p>B2-FH30 P. 161</p>
<p>Code 62 Flange (SAE J518) 45° Elbow</p>  <p>B2-FH45 P. 161</p>	<p>Code 62 Flange (SAE J518) 60° Elbow</p>  <p>B2-FH60 P. 162</p>	<p>Code 62 Flange (SAE J518) 90° Elbow</p>  <p>B2-FH90 P. 162</p>	<p>Caterpillar® Flange</p>  <p>B2-CF P. 163</p>
<p>Caterpillar® Flange 22.5° Elbow</p>  <p>B2-CF22 P. 163</p>	<p>Caterpillar® Flange 45° Elbow</p>  <p>B2-CF45 P. 163</p>	<p>Caterpillar® Flange 60° Elbow</p>  <p>B2-CF60 P. 164</p>	<p>Caterpillar® Flange 67° Elbow</p>  <p>B2-CF67 P. 164</p>
<p>Caterpillar® Flange 90° Elbow</p>  <p>B2-CF90 P. 164</p>	<p>IHUF Hammer Union</p>  <p>B2-IHUF P. 165</p>	<p>IHUM Hammer Union</p>  <p>B2-IHUM P. 165</p>	<p>Komatsu® Flange</p>  <p>B2-KF P. 165</p>
<p>Komatsu® Flange 45° Elbow</p>  <p>B2-KF45 P. 165</p>	<p>Komatsu® Flange 90° Elbow</p>  <p>B2-KF90 P. 166</p>	<p>BSPP (British Standard Pipe Parallel) Female Swivel</p>  <p>B2-BPFX P. 166</p>	<p>BSPP (British Standard Pipe Parallel) Female 45° Elbow Swivel</p>  <p>B2-BPFX45 P. 167</p>



Download the **MyCrimp App** for more information.



















Section 1
B2 Fittings

FITTINGS



B2 Fittings Overview

A complete overview of all B2 fittings found in this section.

<p>BSPP (British Standard Pipe Parallel)</p> <p>Female 90° Elbow Swivel</p>  <p>B2-BPFX90 P. 167</p>	<p>BSPP (British Standard Pipe Parallel)</p> <p>Male</p>  <p>B2-BPM P. 168</p>	<p>BSPT (British Standard Pipe Tapered)</p> <p>Male</p>  <p>B2-BTM P. 168</p>	<p>BSP Flat Seat (British Standard Pipe)</p> <p>Female Swivel</p>  <p>B2-BFFX P. 169</p>
<p>DIN 24° Light</p> <p>Female Swivel</p>  <p>B2-DLFX P. 169</p>	<p>DIN 24° Light</p> <p>Female 45° Elbow Swivel</p>  <p>B2-DLFX45 P. 170</p>	<p>DIN 24° Light</p> <p>Female 90° Elbow Swivel</p>  <p>B2-DLFX90 P. 170</p>	<p>DIN 24° Light</p> <p>Male</p>  <p>B2-DLM P. 171</p>
<p>DIN 24° Heavy</p> <p>Female Swivel</p>  <p>B2-DHFX P. 172</p>	<p>DIN 24° Heavy</p> <p>Female 45° Elbow Swivel</p>  <p>B2-DHFX45 P. 173</p>	<p>DIN 24° Heavy</p> <p>Female 90° Elbow Swivel</p>  <p>B2-DHFX90 P. 174</p>	<p>DIN 24° Heavy</p> <p>Male</p>  <p>B2-DHM P. 175</p>
<p>DIN 60°</p> <p>Female 45° Elbow Swivel</p>  <p>B2-DNFX45 P. 175</p>	<p>DIN 60°</p> <p>Female 90° Elbow Swivel</p>  <p>B2-DNFX90 P. 176</p>	<p>Komatsu® 30° Flare with Metric Threads</p> <p>Female Swivel</p>  <p>B2-KMFX P. 176</p>	<p>Komatsu® 30° Flare with Metric Threads</p> <p>Female 45° Elbow Swivel</p>  <p>B2-KMFX45 P. 177</p>
<p>Komatsu® 30° Flare with Metric Threads</p> <p>Female 90° Elbow Swivel</p>  <p>B2-KMFX90 P. 177</p>	<p>JIS 30° (Parallel Pipe Threads)</p> <p>Female Swivel</p>  <p>B2-JSFX P. 178</p>	<p>Hose Joiner</p> <p>Female</p>  <p>B2-HJ P. 178</p>	

COMPATIBLE HOSE:





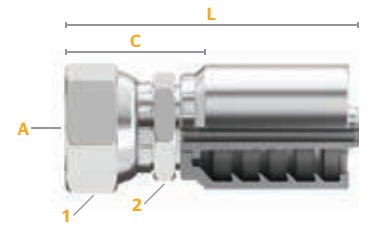

SR1SN	SR2SN	LR16SC	DR16SC	ACP3	SR12
DR1SN	DR2SN	SR16SC	XR16SC	XCP3	ARC12
SFS	LR2SN	ARC16SC	SCP3	XCP4	Hot Oilier

For a detailed list, please refer to your Crimp Specifications Manual.

JIC 37° Flare (SAE J514)

Female / Swivel



Part Number	Product Number	SAP Number										
			Hose ID	Thread Size (A)	Hex 1 Wrench Size	Hex 2 Wrench Size	Cut-Off (C)	Length (L)				
			in.		in.	mm	in.	mm	in.	mm	in.	mm
B2-JCFX-0403	14400-0403	20293242	1/4	3/8-24	9/16	14	1/2	12	1.11	28.1	2.09	53.0
B2-JCFX-0404	14400-0404	20242031	1/4	7/16-20	5/8	16	9/16	14	1.17	29.6	2.15	54.5
B2-JCFX-0404S	14400-0404S	20286835	1/4	7/16-20	5/8	16	9/16	14	1.17	29.6	2.15	54.5
B2-JCFX-0405	14400-0405	20242032	1/4	1/2-20	11/16	17	9/16	14	1.24	31.4	2.22	56.3
B2-JCFX-0406	14400-0406	20242029	1/4	9/16-18	3/4	19	9/16	14	1.23	31.2	2.21	56.1
B2-JCFX-0406S	14400-0406S	20286836	1/4	9/16-18	3/4	19	9/16	14	1.23	31.2	2.21	56.1
B2-JCFX-0505	14400-0505	20242038	5/16	1/2-20	11/16	17	9/16	14	1.24	31.4	2.22	56.3
B2-JCFX-0506	14400-0506	20242037	5/16	9/16-18	3/4	19	9/16	14	1.23	31.2	2.21	56.1
B2-JCFX-0604	14400-0604	20265707	3/8	7/16-20	5/8	16	11/16	17	1.16	29.4	2.21	56.0
B2-JCFX-0604S	14400-0604S	20873071	3/8	7/16-20	5/8	16	11/16	17	1.16	29.4	2.21	56.0
B2-JCFX-0606	14400-0606	20242041	3/8	9/16-18	3/4	19	11/16	17	1.22	31.1	2.27	57.7
B2-JCFX-0606S	14400-0606S	20286837	3/8	9/16-18	3/4	19	11/16	17	1.22	31.1	2.27	57.7
B2-JCFX-0608	14400-0608	20242050	3/8	3/4-16	1	25	3/4	19	1.37	34.9	2.42	61.5
B2-JCFX-0608S	14400-0608S	20286838	3/8	3/4-16	1	25	3/4	19	1.37	34.9	2.42	61.5
B2-JCFX-0610	14400-0610	20242043	3/8	7/8-14	1 1/16	27	7/8	22	1.53	38.8	2.58	65.5
B2-JCFX-0612	14400-0612	20293243	3/8	1 1/16-12	1 1/4	32	1	25	1.64	41.6	2.69	68.3
B2-JCFX-0806	14400-0806	20242034	1/2	9/16-18	3/4	19	3/4	19	1.29	32.8	2.54	64.5
B2-JCFX-0806S	14400-0806S	20424925	1/2	9/16-18	3/4	19	3/4	19	1.29	32.8	2.54	64.5
B2-JCFX-0808	14400-0808	20242008	1/2	3/4-16	1	25	3/4	19	1.44	36.7	2.69	68.4
B2-JCFX-0808S	14400-0808S	20286839	1/2	3/4-16	1	25	3/4	19	1.44	36.7	2.69	68.4
B2-JCFX-0810	14400-0810	20242036	1/2	7/8-14	1 1/16	27	7/8	22	1.56	39.6	2.81	71.3
B2-JCFX-0810S	14400-0810S	20286840	1/2	7/8-14	1 1/16	27	7/8	22	1.56	39.6	2.81	71.3
B2-JCFX-0812	14400-0812	20241925	1/2	1 1/16-12	1 1/4	32	1	25	1.68	42.6	2.93	74.3
B2-JCFX-0816	14400-0816	20293244	1/2	1 1/16-12	1 1/2	38	1 1/4	32	1.83	46.5	3.08	78.2
B2-JCFX-1008	14400-1008	20242005	5/8	3/4-16	1	25	15/16	24	1.52	38.7	2.88	73.2
B2-JCFX-1010	14400-1010	20242004	5/8	7/8-14	1 1/16	27	15/16	24	1.67	42.4	3.03	76.9
B2-JCFX-1010S	14400-1010S	20286841	5/8	7/8-14	1 1/16	27	15/16	24	1.67	42.4	3.03	76.9
B2-JCFX-1012	14400-1012	20242026	5/8	1 1/16-12	1 1/4	32	1	25	1.68	42.6	3.04	77.1
B2-JCFX-1210	14400-1210	20242047	3/4	7/8-14	1 1/4	32	1 1/16	27	1.63	41.4	3.18	80.8
B2-JCFX-1212	14400-1212	20242025	3/4	1 1/16-12	1 1/4	32	1 1/16	27	1.74	44.2	3.29	83.6
B2-JCFX-1212S	14400-1212S	20286842	3/4	1 1/16-12	1 1/4	32	1 1/16	27	1.74	44.2	3.29	83.6
B2-JCFX-1214	14400-1214	20242049	3/4	1 3/16-12	1 1/16	36	1 1/4	32	1.76	44.6	3.31	84.0
B2-JCFX-1216	14400-1216	20242046	3/4	1 1/16-12	1 1/2	38	1 1/4	32	1.89	48.1	3.45	87.5

Continued on the next page.



Download the **MyCrimp App** for more information.

Section 1 B2 Fittings

FITTINGS



JIC 37° Flare (Female) Continued

Part Number	Product Number	SAP Number	Hose ID	Thread Size (A)	Hex 1		Hex 2		Cut-Off (C)		Length (L)	
					Wrench Size	mm	Wrench Size	mm	in.	mm	in.	mm
B2-JCFX-1612	14400-1612	20241921	1	1 1/16-12	1 1/4	32	1 1/4	32	1.88	47.7	3.65	92.8
B2-JCFX-1616	14400-1616	20241916	1	1 3/16-12	1 1/2	38	1 1/4	32	1.96	49.8	3.74	94.9
B2-JCFX-1616S	14400-1616S	20286843	1	1 3/16-12	1 1/2	38	1 1/4	32	1.96	49.8	3.74	94.9
B2-JCFX-1620 ^T	14400-1620	20241919	1	1 1/8-12	2	50	1 3/8	41	2.07	52.5	3.84	97.6
B2-JCFX-2020S ^T	28400-2020S	20289599	1 1/4	1 1/8-12	2	50	1 3/8	41	2.15	54.6	4.20	106.6
B2-JCFX-2020 ^T	28400-2020	20241915	1 1/4	1 1/8-12	2	50	1 3/8	41	2.15	54.6	4.20	106.6
B2-JCFX-2024 ^T	28400-2024	20293262	1 1/4	1 1/8-12	2 3/16	55	2	50	2.45	62.1	4.49	114.1
B2-JCFX-2424S ^T	28400-2424S	20289598	1 1/2	1 1/8-12	2 3/16	55	2	50	2.42	61.4	4.75	120.6
B2-JCFX-2424 ^T	28400-2424	20241928	1 1/2	1 1/8-12	2 3/16	55	2	50	2.42	61.4	4.75	120.6
B2-JCFX-3232 ^T	28400-3232	20242028	2	2 1/2-12	70 mm	70	2 3/16	65	2.88	73.1	5.71	145.1
B2-JCFX-3232S ^T	28400-3232S	20739385	2	2 1/2-12	2 3/4	70	2 3/16	65	2.88	73.1	5.71	145.1

S=Stainless Steel T=Thrust-Wire Nut (See Fitting Identification in Appendix for more information.)

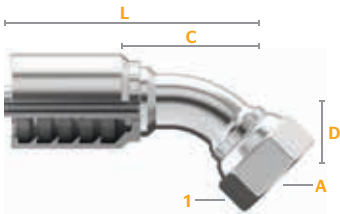

JIC 37° Flare (SAE J514)

Female / 45° Elbow / Swivel



Part Number	Product Number	SAP Number	Hose ID	Thread Size (A)	Hex 1		Drop (D)		Cut-Off (C)		Length (L)	
					Wrench Size	mm	in.	mm	in.	mm	in.	mm
B2-JCFX45-0404	14420-0404	20241948	1/4	7/16-20	5/8	16	0.39	10	1.457	37.0	2.437	61.9
B2-JCFX45-0405	14420-0405	20241962	1/4	1/2-20	11/16	17	0.47	12	1.46	37.0	2.44	61.9
B2-JCFX45-0406	14420-0406	20241949	1/4	9/16-18	3/4	19	0.43	11	1.54	39.0	2.52	63.9
B2-JCFX45-0604	14420-0604	20873201	3/8	7/16-20	5/8	16	0.41	10	1.457	37.1	2.506	63.8
B2-JCFX45-0606	14420-0606	20241950	3/8	9/16-18	3/4	19	0.43	11	1.81	46.0	2.86	72.6
B2-JCFX45-0608	14420-0608	20241954	3/8	3/4-16	1	25	0.59	15	1.85	47.0	2.90	73.6
B2-JCFX45-0806	14420-0806	20873202	1/2	9/16-18	3/4	19	0.59	15	2.047	52.0	3.294	83.7
B2-JCFX45-0808	14420-0808	20241963	1/2	3/4-16	1	25	0.59	15	2.05	52.0	3.29	83.7
B2-JCFX45-0810	14420-0810	20241965	1/2	7/8-14	1 1/16	27	0.63	16	2.01	51.0	3.26	82.7
B2-JCFX45-1010	14420-1010	20241980	5/8	7/8-14	1 1/16	27	0.87	22	2.56	65.0	3.92	99.5
B2-JCFX45-1012	14420-1012	20241967	5/8	1 1/8-12	1 1/4	32	0.83	21	2.72	69.0	4.07	103.5
B2-JCFX45-1212	14420-1212	20241951	3/4	1 1/8-12	1 1/4	32	0.83	21	2.64	67.0	4.19	106.5
B2-JCFX45-1216	14420-1216	20241953	3/4	1 1/8-12	1 1/2	38	1.02	26	2.80	71.0	4.35	110.4
B2-JCFX45-1612	14420-1612	20293221	1	1 1/8-12	1 1/4	32	1.18	30	2.76	70.0	4.53	115.1
B2-JCFX45-1616	14420-1616	20241957	1	1 3/16-12	1 1/2	38	0.95	24	3.11	79.0	4.89	124.1
B2-JCFX45-2020 ^T	28420-2020	20241961	1 1/4	1 1/8-12	2	50	1.46	37	3.82	97.0	6.18	157.0
B2-JCFX45-2424 ^T	28420-2424	20241960	1 1/2	1 1/8-12	2 3/16	55	1.69	43	4.45	113.0	7.15	181.5

T=Thrust-Wire Nut (See Fitting Identification in Appendix for more information.)

FITTINGS



Section 1 B2 Fittings

COMPATIBLE HOSE:

SR1SN	SR2SN	LR16SC	DR16SC	ACP3	SR12
DR1SN	DR2SN	SR16SC	XR16SC	XCP3	ARC12
SFS	LR2SN	ARC16SC	SCP3	XCP4	Hot Oilier

For a detailed list, please refer to your Crimp Specifications Manual.

JIC 37° Flare (SAE J514)

Female / 90° Elbow / Swivel

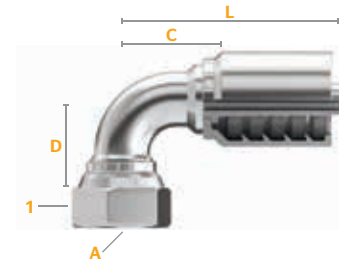

Part Number	Product Number	SAP Number	Hose ID		Thread Size (A)		Hex 1 Wrench Size		Elbow Type*	Drop (D)		Cut-Off (C)		Length (L)	
			in.	mm	in.	mm	in.	mm		in.	mm	in.	mm		
B2-JCFX90-0404	14425-0404	20241909	1/4	7/16-20	5/8	16				1.26	32.0	1.34	34.0	2.32	58.9
B2-JCFX90-0404S	14425-0404S	20873072	1/4	7/16-20	5/8	16				1.26	32.0	1.34	34.0	2.32	58.9
B2-JCFX90L-0404	14440-0404	20241985	1/4	7/16-20	5/8	16		LT		1.81	46.0	1.25	31.8	2.23	56.7
B2-JCFX90S-0404	14445-0404	20241929	1/4	7/16-20	5/8	16		ST		0.83	21.0	1.06	27.0	2.04	51.9
B2-JCFX90S-0404S	14445-0404S	20797255	1/4	7/16-20	5/8	16		ST		0.83	21.0	1.06	27.0	2.04	51.9
B2-JCFX90-0405	14425-0405	20241913	1/4	1/2-20	11/16	17				1.18	30.0	1.02	26.0	2.00	50.9
B2-JCFX90L-0405	14440-0405	20241988	1/4	1/2-20	11/16	17		LT		1.77	45.0	1.02	26.0	2.00	50.9
B2-JCFX90S-0405	14445-0405	20241938	1/4	1/2-20	11/16	17		ST		0.93	23.5	1.02	26.0	2.00	50.9
B2-JCFX90-0406	14425-0406	20241896	1/4	9/16-18	3/4	19				1.50	38.0	1.10	28.0	2.08	52.9
B2-JCFX90-0406S	14425-0406S	20873073	1/4	9/16-18	3/4	19				1.50	38.0	1.10	28.0	2.08	52.9
B2-JCFX90L-0406	14440-0406	20241970	1/4	9/16-18	3/4	19		LT		2.13	54.0	1.34	34.0	2.32	58.9
B2-JCFX90S-0406	14445-0406	20241939	1/4	9/16-18	3/4	19		ST		0.91	23.0	1.22	31.0	2.20	55.9
B2-JCFX90-0505	14425-0505	20873172	5/16	1/2-20	11/16	17				1.38	35.0	1.34	34.0	2.32	58.9
B2-JCFX90-0506	14425-0506	20873173	5/16	9/16-18	3/4	19				1.38	35.0	1.30	33.0	2.28	57.9
B2-JCFX90-0604	14425-0604	20293223	3/8	7/16-20	5/8	16				1.26	32.0	1.38	35.0	2.43	61.6
B2-JCFX90-0604S	14425-0604S	20873074	3/8	7/16-20	5/8	16				1.26	32.0	1.38	35.0	2.43	61.6
B2-JCFX90L-0604	14440-0604	20293222	3/8	7/16-20	5/8	16		LT		1.81	46.0	1.22	31.0	2.27	57.6
B2-JCFX90S-0604	14445-0604	20265709	3/8	7/16-20	5/8	16		ST		0.83	21.0	1.10	28.0	2.15	54.6
B2-JCFX90-0606	14425-0606	20241902	3/8	9/16-18	3/4	19				1.38	35.0	1.22	31.0	2.27	57.6
B2-JCFX90-0606S	14425-0606S	20873075	3/8	9/16-18	3/4	19				1.38	35.0	1.22	31.0	2.27	57.6
B2-JCFX90L-0606	14440-0606	20241974	3/8	9/16-18	3/4	19		LT		2.13	54.0	1.69	43.0	2.74	69.6
B2-JCFX90S-0606	14445-0606	20241944	3/8	9/16-18	3/4	19		ST		0.91	23.0	1.65	42.0	2.70	68.7
B2-JCFX90-0608	14425-0608	20241895	3/8	3/4-16	1	25				1.61	41.0	1.54	39.0	2.58	65.6
B2-JCFX90-0608S	14425-0608S	20873076	3/8	3/4-16	1	25				1.61	41.0	1.54	39.0	2.58	65.6
B2-JCFX90L-0608	14440-0608	20241973	3/8	3/4-16	1	25		LT		2.52	64.0	1.85	47.0	2.90	73.6
B2-JCFX90S-0608	14445-0608	20241943	3/8	3/4-16	1	25		ST		1.14	29.0	1.93	49.0	2.98	75.6
B2-JCFX90-0806	14425-0806	20873203	1/2	9/16-18	3/4	19				1.50	38.1	1.50	38.1	2.51	63.8
B2-JCFX90-0808	14425-0808	20241914	1/2	3/4-16	1	25				1.58	40.0	1.46	37.0	2.70	68.7
B2-JCFX90L-0808	14440-0808	20241978	1/2	3/4-16	1	25		LT		2.52	64.0	1.97	50.0	3.22	81.7
B2-JCFX90S-0808	14445-0808	20241936	1/2	3/4-16	1	25		ST		1.14	29.0	1.81	46.0	3.06	77.7
B2-JCFX90-0808S	14425-0808S	20424924	1/2	3/4-16	1	25				1.58	40.0	1.46	37.0	2.70	68.7
B2-JCFX90-0810	14425-0810	20241911	1/2	7/8-14	1 1/16	27				1.85	47.0	1.69	43.0	2.94	74.7
B2-JCFX90L-0810	14440-0810	20241987	1/2	7/8-14	1 1/16	27		LT		2.56	65.0	1.46	37.0	2.70	68.7
B2-JCFX90S-0810	14445-0810	20241946	1/2	7/8-14	1 1/16	27		ST		1.26	32.0	1.81	46.0	3.06	77.7
B2-JCFX90-0812	14425-0812	20241908	1/2	1 1/16-12	1 1/4	32				1.81	46.0	1.46	37.0	2.70	68.7

Continued on the next page.



Download the **MyCrimp App** for more information.

Section 1
B2 Fittings

FITTINGS



JIC 37° Flare (Female 90° Elbow) Continued

Part Number	Product Number	SAP Number	Hose ID	Thread Size (A)	Hex 1		Elbow Type*	Drop (D)		Cut-Off (C)		Length (L)	
					Wrench Size	mm		in.	mm	in.	mm	in.	mm
B2-JCFX90-1010	14425-1010	20241932	5/8	7/8-14	1 1/16	27		1.89	48.0	1.93	49.0	3.29	83.5
B2-JCFX90-1010S	14425-1010S	20873077	5/8	7/8-14	1 1/16	27		1.89	48.0	1.93	49.0	3.29	83.5
B2-JCFX90L-1010	14440-1010	20241976	5/8	7/8-14	1 1/16	27	LT	2.56	65.0	1.97	50.0	3.32	84.4
B2-JCFX90S-1010	14445-1010	20241923	5/8	7/8-14	1 1/16	27	ST	1.26	32.0	1.93	49.0	3.29	83.5
B2-JCFX90-1012	14425-1012	20241930	5/8	1 1/16-12	1 1/4	32		2.28	58.0	1.89	48.0	3.25	82.5
B2-JCFX90S-1012	14445-1012	20241945	5/8	1 1/16-12	1 1/4	32	ST	1.89	48.0	1.89	48.0	3.25	82.5
B2-JCFX90S-1208	14445-1208	20265741	3/4	3/4-16	1	25	ST	1.14	29.0	1.65	42.0	3.21	81.5
B2-JCFX90-1210	14425-1210	20293224	3/4	7/8-14	1 1/16	27		1.89	48.0	1.97	50.0	3.52	89.5
B2-JCFX90-1212	14425-1212	20241897	3/4	1 1/16-12	1 1/4	32		2.13	54.0	2.05	52.0	3.60	91.4
B2-JCFX90-1212S	14425-1212S	20873078	3/4	1 1/16-12	1 1/4	32		2.13	54.0	2.05	52.0	3.60	91.4
B2-JCFX90L-1212	14440-1212	20241971	3/4	1 1/16-12	1 1/4	32	LT	3.74	95.0	2.13	54.0	3.68	93.4
B2-JCFX90S-1212	14445-1212	20241940	3/4	1 1/16-12	1 1/4	32	ST	1.81	46.0	2.28	58.0	3.84	97.4
B2-JCFX90S-1212S	14445-1212S	20797257	3/4	1 1/16-12	1 1/4	32	ST	1.81	46.0	2.28	58.0	3.84	97.4
B2-JCFX90S-1214	14445-1214	20241942	3/4	1 3/16-12	1 7/16	36	ST	2.07	52.6	1.93	49.0	3.48	88.5
B2-JCFX90-1216	14425-1216	20241900	3/4	1 1/16-12	1 1/2	38		2.84	72.0	2.09	53.0	3.64	92.5
B2-JCFX90S-1216	14445-1216	20662000	3/4	1 1/16-12	1 1/2	38	ST	2.28	57.8	1.99	50.5	3.54	90.0
B2-JCFX90-1616	14425-1616	20241977	1	1 1/16-12	1 1/2	38		2.81	71.4	2.89	73.4	4.67	118.5
B2-JCFX90-1616S	14425-1616S	20873132	1	1 1/16-12	1 1/2	38		2.81	71.4	2.89	73.4	4.67	118.5
B2-JCFX90L-1616	14440-1616	20241983	1	1 1/16-12	1 1/2	38	LT	4.49	114.0	3.11	79.0	4.89	124.1
B2-JCFX90L-1616S	14440-1616S	20873133	1	1 1/16-12	1 1/2	38	LT	4.49	114.0	3.11	79.0	4.89	124.1
B2-JCFX90S-1616	14445-1616	20241934	1	1 1/16-12	1 1/2	38	ST	2.21	56.0	2.91	74.0	4.69	119.1
B2-JCFX90S-1616S	14445-1616S	20797550	1	1 1/16-12	1 1/2	38	ST	2.21	56.0	2.91	74.0	4.69	119.1
B2-JCFX90-2020S ^T	28425-2020S	20873135	1 1/4	1 1/16-12	2	50		3.07	78.0	3.23	82.0	5.28	134.0
B2-JCFX90-2020 ^T	28425-2020	20241906	1 1/4	1 1/16-12	2	50		3.07	78.0	3.23	82.0	5.28	134.0
B2-JCFX90-2024 ^T	28425-2024	20432492	1 1/4	1 1/16-12	2 3/16	55		3.386	86.1	3.937	100.0	5.938	150.9
B2-JCFX90-2424S ^T	28425-2424S	20933821	1 1/2	1 1/16-12	2 3/16	55		3.62	91.9	3.94	100.0	6.27	159.1
B2-JCFX90-2424 ^T	28425-2424	20241904	1 1/2	1 1/16-12	2 3/16	55		3.62	91.9	3.94	100.0	6.27	159.1
B2-JCFX90-3232S ^T	28425-3232S	20933822	2	2 1/16-12	2 3/4	70		5.51	140.0	5.08	129.0	7.914	200.9
B2-JCFX90-3232 ^T	28425-3232	20657096	2	2 1/16-12	2 3/4	70		5.51	140.0	5.08	129.0	7.91	200.9

S=Stainless Steel T=Thrust-Wire Nut (See Fitting Identification in Appendix for more information) *Elbow Type: LT=Long Tube ST=Short Tube

FITTINGS



Section 1

B2 Fittings

COMPATIBLE HOSE:

SR1SN	SR2SN	LR16SC	DR16SC	ACP3	SR12
DR1SN	DR2SN	SR16SC	XR16SC	XCP3	ARC12
SFS	LR2SN	ARC16SC	SCP3	XCP4	Hot Oilier

For a detailed list, please refer to your Crimp Specifications Manual.

JIC 37° Flare (SAE J514)

Female / 90° Block Elbow / Swivel

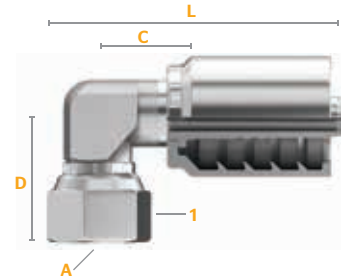

Part Number	Product Number	SAP Number	Hose ID	Thread Size (A)	Hex 1 Wrench Size		Drop (D)		Cut-Off (C)		Length (L)	
					in.	mm	in.	mm	in.	mm	in.	mm
B2-JCFX90B-0404	14447-0404	20840617	1/4	7/16 - 20	5/8	19	1.14	29.0	0.71	18.0	1.69	42.9
B2-JCFX90B-0606	14447-0606	20840880	3/8	9/16 - 18	3/4	25	1.13	28.7	0.87	22.1	1.92	48.8
B2-JCFX90B-0808	14447-0808	20840881	1/2	3/4 - 16	1	16	1.66	42.2	1.1	27.9	2.41	61.2

JIC 37° Flare (SAE J514)

Male

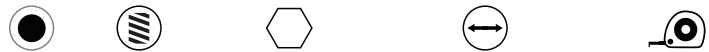
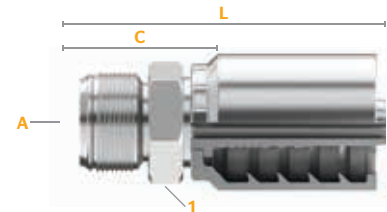

Part Number	Product Number	SAP Number	Hose ID	Thread Size (A)	Hex 1 Wrench Size		Cut-Off (C)		Length (L)	
					in.	mm	in.	mm	in.	mm
B2-JCM-0404	14450-0404	20241990	1/4	7/16-20	1/2	12	0.99	25.2	1.97	50.1
B2-JCM-0405	14450-0405	20241991	1/4	1/2-20	9/16	14	1.03	26.2	2.01	51.1
B2-JCM-0406	14450-0406	20241995	1/4	9/16-18	11/16	17	1.04	26.4	2.02	51.3
B2-JCM-0506	14450-0506	20242012	5/16	9/16-18	11/16	17	1.04	26.5	2.02	51.4
B2-JCM-0606	14450-0606	20242014	3/8	9/16-18	11/16	17	1.05	26.6	2.10	53.2
B2-JCM-0608	14450-0608	20242007	3/8	3/4-16	3/4	19	1.14	28.9	2.19	55.5
B2-JCM-0610	14450-0610	20242024	3/8	7/8-14	15/16	24	1.33	33.8	2.38	60.5
B2-JCM-0808	14450-0808	20241994	1/2	3/4-16	3/4	19	1.17	29.8	2.42	61.4
B2-JCM-0808S	14450-0808S	20424921	1/2	3/4-16	3/4	19	1.17	29.8	2.42	61.4
B2-JCM-0810	14450-0810	20241993	1/2	7/8-14	15/16	24	1.35	34.4	2.60	66.0
B2-JCM-0812	14450-0812	20241997	1/2	1 1/16 - 12	1 1/16	27	1.46	37.1	2.71	68.7
B2-JCM-1008	14450-1008	20441227	5/8	3/4-16	15/16	24	1.21	30.8	2.57	65.3
B2-JCM-1010	14450-1010	20242010	5/8	7/8-14	15/16	24	1.38	35.0	2.73	69.4
B2-JCM-1012	14450-1012	20242011	5/8	1 1/16 - 12	1 1/16	27	1.46	37.1	2.82	71.5
B2-JCM-1210	14450-1210	20293165	3/4	7/8-14	1 1/16	27	1.38	35.0	2.93	74.4
B2-JCM-1212	14450-1212	20242022	3/4	1 1/16 - 12	1 1/16	27	1.48	37.7	3.04	77.1
B2-JCM-1214	14450-1214	20242020	3/4	1 3/16 - 12	1 1/4	32	1.62	41.0	3.17	80.5
B2-JCM-1216	14450-1216	20242018	3/4	1 3/16 - 12	1 3/16	36	1.66	42.2	3.21	81.6

Continued on the next page.



Download the **MyCrimp App** for more information.

Section 1
B2 Fittings

FITTINGS



JIC 37° Flare (Male) Continued

Part Number	Product Number	SAP Number	Hose ID	Thread Size (A)	Hex 1		Cut-Off (C)		Length (L)	
					Wrench Size	mm	in.	mm	in.	mm
B2-JCM-1616	14450-1616	20242002	1	1 1/16-12	1 1/16	36	1.67	42.4	3.45	87.5
B2-JCM-1620	14450-1620	20242016	1	1 3/8-12	1 1/16	46	1.84	46.8	3.62	91.9
B2-JCM-2020	28450-2020	20241999	1 1/4	1 3/8-12	1 1/16	46	1.91	48.5	3.96	100.5
B2-JCM-2020S	28450-2020S	20933823	1 1/4	1 3/8-12	1 1/16	46	1.91	48.6	3.96	100.5
B2-JCM-2024	28450-2024	20241998	1 1/4	1 7/8-12	2	50	2.08	52.8	4.12	104.7
B2-JCM-2424	28450-2424	20242027	1 1/2	1 7/8-12	2	50	2.08	52.7	4.40	111.8
B2-JCM-2424S	28450-2424S	20933824	1 1/2	1 7/8-12	2	50	2.08	52.7	4.40	111.8
B2-JCM-3232	28450-3232	20242023	2	2 1/2-12	2 3/16	65	2.45	62.1	5.28	134.1
B2-JCM-3232S	28450-3232S	20933825	2	2 1/2-12	2 3/16	65	2.45	62.1	5.28	134.1

S=Stainless Steel (See Fitting Identification in Appendix for more information.)

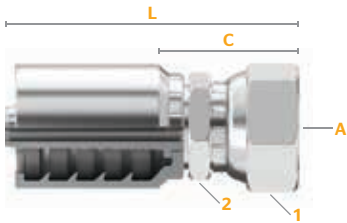

SAE 45° J512 Flare

Female / Swivel

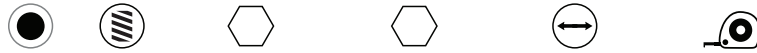

Part Number	Product Number	SAP Number	Hose ID	Thread Size (A)	Hex 1		Hex 2		Cut-Off (C)		Length (L)	
					Wrench Size	mm	in.	mm	in.	mm	in.	mm
B2-SFFX-0606	14775-0606	20241706	3/8	5/8-18	7/8	22	3/4	19	1.32	33.6	2.371	60.2
B2-SFFX-0608	14775-0608	20293245	3/8	3/4-16	1	25	3/4	19	1.37	34.9	2.423	61.5
B2-SFFX-0808	14775-0808	20662003	1/2	3/4-16	1 1/16	27	3/4	19	1.3	33.6	2.4	60.2
B2-SFFX-0810	14775-0810	20293246	1/2	7/8-14	1 1/16	27	7/8	22	1.60	40.6	2.846	72.3
B2-SFFX-1212	14775-1212	20241707	3/4	1 1/16-14	1 1/4	32	1 1/16	27	1.74	44.2	3.29	83.6

FITTINGS



Section 1

B2 Fittings

COMPATIBLE HOSE:

SR1SN	SR2SN	LR16SC	DR16SC	ACP3	SR12
DR1SN	DR2SN	SR16SC	XR16SC	XCP3	ARC12
SFS	LR2SN	ARC16SC	SCP3	XCP4	Hot Oilier

For a detailed list, please refer to your Crimp Specifications Manual.

SAE 45° J512 Flare

Female / 45° Elbow / Swivel

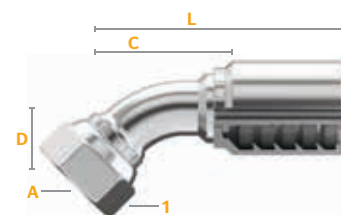

Part Number	Product Number	SAP Number	Hose ID	Thread Size (A)	Hex 1 Wrench Size		Drop (D)		Cut-Off (C)		Length (L)	
			in.		in.	mm	in.	mm	in.	mm	in.	mm
B2-SFFX45-0606	14777-0606	20293247	3/8	5/8-18	7/8	22	0.47	12.0	1.81	45.99	2.86	72.64
B2-SFFX45-0808	14777-0808	20293248	1/2	3/4-16	1	25	0.59	15.0	2.05	51.99	3.294	83.67
B2-SFFX45-1212	14777-1212	20441271	3/4	1 1/8-14	1 1/4	32	0.83	21.0	2.64	67.0	4.191	106.5

SAE 45° J512 Flare

Female / 90° Elbow / Swivel

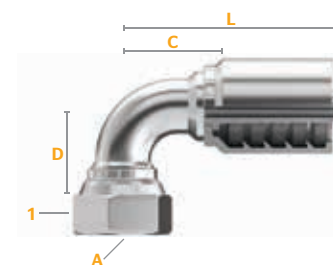

Part Number	Product Number	SAP Number	Hose ID	Thread Size (A)	Hex 1 Wrench Size		Drop (D)		Cut-Off (C)		Length (L)	
			in.		in.	mm	in.	mm	in.	mm	in.	mm
B2-SFFX90-0606	14780-0606	20293249	3/8	5/8-18	7/8	22	0.95	24.0	1.654	42.0	2.70	68.7
B2-SFFX90L-0606	14781-0606	20293250	3/8	5/8-18	7/8	22	2.19	55.5	1.693	43.0	2.74	69.6
B2-SFFX90S-0808	14783-0808	20293251	1/2	3/4-16	1	25	1.14	29.0	1.811	46.0	3.06	77.7
B2-SFFX90-1212	14780-1212	20441304	3/4	1 1/8-14	1 1/4	32	1.85	47.0	1.69	43.0	2.94	74.7



Download the **MyCrimp App** for more information.

Section 1
B2 Fittings

FITTINGS



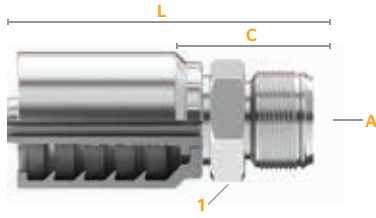

SAE 45° J512 Flare

Male



Part Number	Product Number	SAP Number	Hose ID	Thread Size (A)	Hex 1 Wrench Size		Cut-Off (C)		Length (L)	
			in.		in.	mm	in.	mm	in.	mm
B2-SFM-0606	14785-0606	20293213	3/8	5/8-18	5/8	16	1.12	28.5	2.17	55.2
B2-SFM-0608	14785-0608	20293214	3/8	3/4-16	3/4	19	1.23	31.2	2.28	57.9
B2-SFM-0808	14785-0808	20293215	1/2	3/4-16	3/4	19	1.27	32.1	2.51	63.8
B2-SFM-1212	14785-1212	20293216	3/4	1 1/8-14	1 1/8	27	1.62	41.1	3.17	80.6

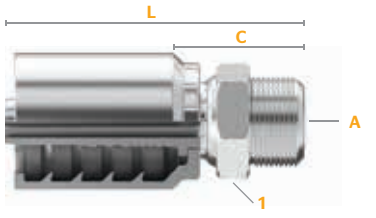

SAE 45° Inverted Flare

Male / Swivel



Part Number	Product Number	SAP Number	Hose ID	Thread Size (A)	Hex 1 Wrench Size		Cut-Off (C)		Length (L)	
			in.		in.	mm	in.	mm	in.	mm
B2-SIMX-0403	14800-0403	20293166	1/4	3/8-24	1/2	12	1.68	42.7	2.663	67.6
B2-SIMX-0404	14800-0404	20293167	1/4	7/16-24	1/2	12	1.70	43.1	2.675	67.9
B2-SIMX-0405	14800-0405	20293168	1/4	1/2-20	9/16	14	1.83	46.6	2.814	71.5
B2-SIMX-0605	14800-0605	20293169	3/8	1/2-20	9/16	14	1.84	46.8	2.89	73.4
B2-SIMX-0606	14800-0606	20293170	3/8	5/8-18	11/16	17	1.89	48.0	2.94	74.7
B2-SIMX-0607	14800-0607	20293171	3/8	11/16-18	3/4	19	1.92	48.7	2.965	75.3
B2-SIMX-0808	14800-0808	20293172	1/2	3/4-18	3/4	19	2.00	50.8	3.248	82.5
B2-SIMX-0810	14800-0810	20293173	1/2	7/8-18	15/16	24	2.07	52.7	3.321	84.4

FITTINGS



Section 1

B2 Fittings

COMPATIBLE HOSE:

SR1SN	SR2SN	LR16SC	DR16SC	ACP3	SR12
DR1SN	DR2SN	SR16SC	XR16SC	XCP3	ARC12
SFS	LR2SN	ARC16SC	SCP3	XCP4	Hot Oilier

For a detailed list, please refer to your Crimp Specifications Manual.

SAE 45° Inverted Flare

Male / 45° Elbow / Swivel

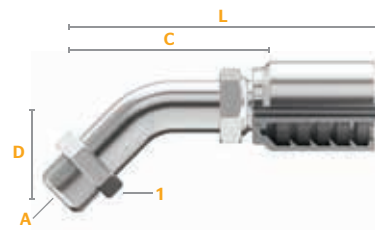

Part Number	Product Number	SAP Number	Hose ID		Thread Size (A)		Hex 1 Wrench Size		Drop (D)		Cut-Off (C)		Length (L)	
			in.	mm	in.	mm	in.	mm	in.	mm	in.	mm		
B2-SIMX45-0403	14810-0403	20293174	1/4		3/8-24		1/2	12	1.24	31.49	2.68	68.1	3.66	93.0
B2-SIMX45-0404	14810-0404	20293175	1/4		7/16-24		1/2	12	1.24	31.49	2.68	68.1	3.66	93.0
B2-SIMX45-0604	14810-0604	20293382	3/8		7/16-24		1/2	12	1.57	39.87	2.95	74.9	4.00	101.6
B2-SIMX45-0605	14810-0605	20293177	3/8		1/2-20		9/16	14	1.50	38.10	2.99	75.9	4.04	102.6
B2-SIMX45-0606	14810-0606	20293178	3/8		5/8-18		11/16	17	1.50	38.10	2.99	75.9	4.04	102.6
B2-SIMX45-0607	14810-0607	20293179	3/8		11/16-18		3/4	19	1.50	38.10	2.99	75.9	4.04	102.6

SAE 45° Inverted Flare

Male / 90° Elbow / Swivel

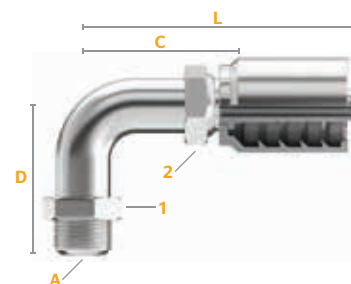

Part Number	Product Number	SAP Number	Hose ID		Thread Size (A)		Hex 1 Wrench Size		Drop (D)		Cut-Off (C)		Length (L)	
			in.	mm	in.	mm	in.	mm	in.	mm	in.	mm		
B2-SIMX90-0403	14815-0403	20293180	1/4		3/8-24		1/2	12	1.97	50.0	1.38	35.1	2.36	59.9
B2-SIMX90-0404	14815-0404	20293181	1/4		7/16-24		1/2	12	2.05	52.1	1.30	33.0	2.28	57.9
B2-SIMX90-0405	14815-0405	20293182	1/4		1/2-20		9/16	14	1.96	49.8	1.52	38.6	2.50	63.5
B2-SIMX90-0604	14815-0604	20293183	3/8		7/16-24		1/2	12	2.44	62.0	1.34	34.0	2.39	60.7
B2-SIMX90-0605	14815-0605	20293184	3/8		1/2-20		9/16	14	2.44	62.0	1.38	35.1	2.43	61.7
B2-SIMX90-0606	14815-0606	20293185	3/8		5/8-18		11/16	17	2.44	62.0	1.38	35.1	2.43	61.7
B2-SIMX90-0607	14815-0607	20293186	3/8		11/16-18		3/4	19	2.44	62.0	1.38	35.1	2.43	61.7
B2-SIMX90-0808	14815-0808	20293187	1/2		3/4-18		3/4	19	2.32	58.9	2.13	54.1	3.38	85.8



Download the **MyCrimp App** for more information.

Section 1
B2 Fittings

FITTINGS



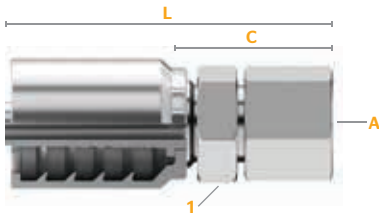

NPTF

Female



Part Number	Product Number	SAP Number	Hose ID	Thread Size (A)	Hex 1 Wrench Size		Cut-Off (C)		Length (L)	
			in.		in.	mm	in.	mm	in.	mm
B2-NPF-0402	14600-0402	20293225	1/4	1/8-27	9/16	14	0.88	22.4	1.86	47.3
B2-NPF-0404	14600-0404	20242105	1/4	1/4-18	3/4	19	1.09	27.6	2.07	52.5
B2-NPF-0604	14600-0604	20293226	3/8	1/4-18	3/4	19	1.09	27.8	2.14	54.4
B2-NPF-0606	14600-0606	20242103	3/8	3/8-18	7/8	22	1.15	29.2	2.19	55.8
B2-NPF-0608	14600-0608	20662001	3/8	1/2-14	1	25	1.38	35.0	2.43	61.7
B2-NPF-0806	14600-0806	20662002	1/2	3/8-18	7/8	22	1.18	30.0	2.42	61.5
B2-NPF-0808	14600-0808	20242106	1/2	1/2-14	1	25	1.40	35.6	2.65	67.2
B2-NPF-1212	14600-1212	20242104	3/4	3/4-14	1 1/4	32	1.51	38.4	3.06	77.8

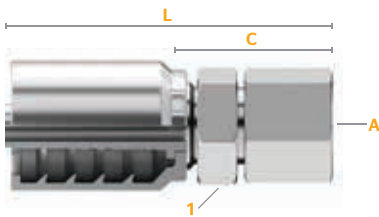

NPTF

Female / Swivel



Part Number	Product Number	SAP Number	Hose ID	Thread Size (A)	Hex 1 Wrench Size		Cut-Off (C)		Length (L)	
			in.		in.	mm	in.	mm	in.	mm
B2-NPFX-0606	14605-0606	20293227	3/8	3/8-18	7/8	22	2.06	52.4	3.11	79.0
B2-NPFX-1616	14605-1616	20293228	1	1-11 1/2	1 1/2	38	2.83	71.8	4.60	116.9

FITTINGS



Section 1

B2 Fittings

COMPATIBLE HOSE:

SR1SN	SR2SN	LR16SC	DR16SC	ACP3	SR12
DR1SN	DR2SN	SR16SC	XR16SC	XCP3	ARC12
SFS	LR2SN	ARC16SC	SCP3	XCP4	Hot Oilier

For a detailed list, please refer to your Crimp Specifications Manual.

NPTF

Male

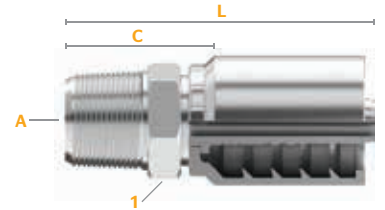

Part Number	Product Number	SAP Number	Hose ID	Thread Size (A)	Hex 1 Wrench Size		Cut-Off (C)		Length (L)	
			in.		in.	mm	in.	mm	in.	mm
B2-NPM-0402	14615-0402	20242110	1/4	1/8-27	9/16	14	0.84	21.2	1.82	46.1
B2-NPM-0404	14615-0404	20242111	1/4	1/4-18	11/16	17	1.06	27.0	2.04	51.9
B2-NPM-0404S	14615-0404S	20286649	1/4	1/4-18	11/16	17	1.06	27.0	2.04	51.9
B2-NPM-0406	14615-0406	20242109	1/4	3/8-18	3/4	19	1.09	27.7	2.07	52.6
B2-NPM-0406S	14615-0406S	20873079	1/4	3/8-18	3/4	19	1.09	27.7	2.07	52.6
B2-NPM-0408	14615-0408	20242115	1/4	1/2-14	7/8	22	1.27	32.2	2.25	57.1
B2-NPM-0604	14615-0604	20242067	3/8	1/4-18	11/16	17	1.07	27.2	2.12	53.8
B2-NPM-0604S	14615-0604S	20873130	3/8	1/4-18	11/16	17	1.07	27.2	2.12	53.8
B2-NPM-0606	14615-0606	20242069	3/8	3/8-18	3/4	19	1.10	27.9	2.15	54.6
B2-NPM-0606S	14615-0606S	20286830	3/8	3/8-18	3/4	19	1.10	27.9	2.15	54.6
B2-NPM-0608	14615-0608	20242079	3/8	1/2-14	7/8	22	1.27	32.4	2.32	59.0
B2-NPM-0608S	14615-0608S	20873131	3/8	1/2-14	7/8	22	1.27	32.4	2.32	59.0
B2-NPM-0806	14615-0806	20242113	1/2	3/8-18	3/4	19	1.12	28.4	2.37	60.1
B2-NPM-0806S	14615-0806S	20424922	1/2	3/8-18	3/4		1.12	28.4	2.37	60.1
B2-NPM-0808	14615-0808	20242093	1/2	1/2-14	7/8	22	1.30	33.0	2.55	64.7
B2-NPM-0808S	14615-0808S	20286831	1/2	1/2-14	7/8	22	1.30	33.0	2.55	64.7
B2-NPM-0812	14615-0812	20242116	1/2	3/4-14	1 1/8	27	1.34	34.1	2.59	65.8
B2-NPM-1008	14615-1008	20242071	5/8	1/2-14	15/16	24	1.31	33.3	2.67	67.7
B2-NPM-1008S	14615-1008S	20286832	5/8	1/2-14	15/16	24	1.31	33.3	2.67	67.7
B2-NPM-1012	14615-1012	20242066	5/8	3/4-14	1 1/8	27	1.35	34.4	2.71	68.9
B2-NPM-1208	14615-1208	20242078	3/4	1/2-14	1 1/8	27	1.32	33.5	2.87	73.0
B2-NPM-1212	14615-1212	20242076	3/4	3/4-14	1 1/8	27	1.36	34.6	2.92	74.1
B2-NPM-1212S	14615-1212S	20286833	3/4	3/4-14	1 1/8	27	1.36	34.6	2.92	74.1
B2-NPM-1216	14615-1216	20242077	3/4	1-11 1/2	1 1/8	36	1.72	43.7	3.27	83.1
B2-NPM-1612	14615-1612	20242107	1	3/4-14	1 1/8	36	1.56	39.5	3.33	84.6
B2-NPM-1616	14615-1616	20242099	1	1-11 1/2	1 1/8	36	1.73	43.9	3.51	89.0
B2-NPM-1616S	14615-1616S	20286834	1	1-11 1/2	1 1/8	36	1.73	43.9	3.51	89.0
B2-NPM-1620	14615-1620	20242092	1	1 1/4-11 1/2	1 1/8	46	1.88	47.8	3.66	92.8
B2-NPM-2020	28615-2020	20242094	1 1/4	1 1/4-11 1/2	1 1/8	46	1.95	49.5	4.00	101.5
B2-NPM-2020S	28615-2020S	20424930	1 1/4	1 1/4-11 1/2	1 1/8	46	1.95	49.5	4.00	101.5
B2-NPM-2024	28615-2024	20242095	1 1/4	1 1/2-11 1/2	2	50	2.01	51.0	4.06	103.0
B2-NPM-2424	28615-2424	20242102	1 1/2	1 1/2-11 1/2	2	50	2.01	51.0	4.34	110.1
B2-NPM-2424S	28615-2424S	20424931	1 1/2	1 1/2-11 1/2	2	50	2.01	51.0	4.34	110.1
B2-NPM-3232	28615-3232	20242108	2	2-11 1/2	2 1/8	65	2.14	54.5	4.98	126.4
B2-NPM-3232S	28615-3232S	20933826	2	2-11 1/2	2 1/8	65	2.14	54.5	4.98	126.4

S=Stainless Steel (See Fitting Identification in Appendix for more information.)



Download the **MyCrimp App** for more information.

Section 1
B2 Fittings

FITTINGS



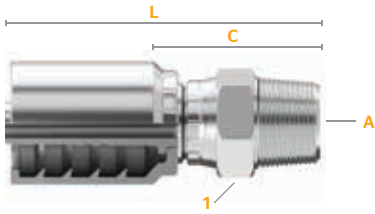

NPTF

Male / Swivel



Part Number	Product Number	SAP Number	Hose ID	Thread Size (A)	Hex 1 Wrench Size		Cut-Off (C)		Length (L)	
			in.		in.	mm	in.	mm	in.	mm
B2-NPMX-0402	14645-0402	20435592	1/4	1/8-27	5/8	16	1.51	38.4	2.49	63.1
B2-NPMX-0404	14645-0404	20242087	1/4	1/4-18	11/16	17	1.49	37.8	2.47	62.7
B2-NPMX-0404S	14645-0404S	20838415	1/4	1/4-18	11/16	17	1.49	37.8	2.47	62.7
B2-NPMX-0406	14645-0406	20242086	1/4	3/8-18	7/8	22	1.57	39.9	2.55	64.8
B2-NPMX-0604	14645-0604	20242082	3/8	1/4-18	11/16	17	1.58	40.1	2.63	66.8
B2-NPMX-0606	14645-0606	20242081	3/8	3/8-18	7/8	22	1.49	37.8	2.54	64.4
B2-NPMX-0606S	14645-0606S	20838416	3/8	3/8-18	7/8	22	1.49	37.8	2.54	64.4
B2-NPMX-0608	14645-0608	20242083	3/8	1/2-14	1	25	1.71	43.5	2.76	70.2
B2-NPMX-0804	14645-0804	20293188	1/2	1/4-18	11/16	17	1.60	40.6	2.85	72.3
B2-NPMX-0806	14645-0806	20242088	1/2	3/8-18	7/8	22	1.51	38.5	2.76	70.1
B2-NPMX-0808	14645-0808	20242074	1/2	1/2-14	1	25	1.66	42.3	2.91	73.9
B2-NPMX-0808S	14645-0808S	20838417	1/2	1/2-14	1	25	1.66	42.3	2.91	73.9
B2-NPMX-1208	14645-1208	20923064	3/4	1/2-14	1	25	1.73	43.9	3.283	83.3
B2-NPMX-1212	14645-1212	20242091	3/4	3/4-14	1 1/4	32	1.97	50.1	3.53	89.6
B2-NPMX-1212S	14645-1212S	20838418	3/4	3/4-14	1 1/4	32	1.97	50.1	3.53	89.6
B2-NPMX-1616	14645-1616	20242085	1	1-11 1/2	1 3/8	41	2.30	58.4	4.07	103.5
B2-NPMX-1616S	14645-1616S	20838419	1	1-11 1/2	1 3/8	41	2.30	58.4	4.07	103.5

FITTINGS



Section 1

B2 Fittings

COMPATIBLE HOSE:





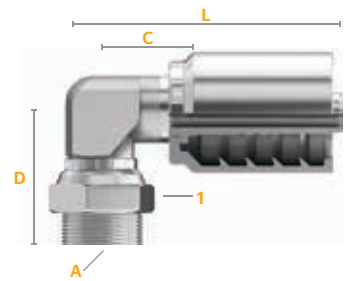

SR1SN	SR2SN	LR16SC	DR16SC	ACP3	SR12
DR1SN	DR2SN	SR16SC	XR16SC	XCP3	ARC12
SFS	LR2SN	ARC16SC	SCP3	XCP4	Hot Oiler

For a detailed list, please refer to your Crimp Specifications Manual.

NPTF

Male / 90° Block Elbow / Swivel







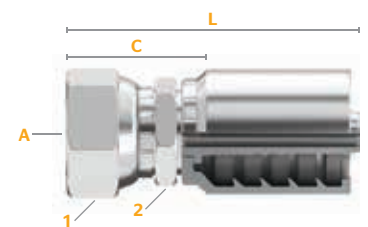

Part Number	Product Number	SAP Number										
			Hose ID	Thread Size (A)	Hex 1 Wrench Size		Drop (D)		Cut-Off (C)		Length (L)	
			in.		in.	mm	in.	mm	in.	mm	in.	mm
B2-NPMX90B-0404	14650-0404	20293189	1/4	1/4-18	11/16	17	1.69	42.9	0.71	18.1	1.69	43.0
B2-NPMX90B-0604	14650-0604	20293190	3/8	1/4-18	11/16	17	1.63	41.5	0.92	23.3	1.97	50.0
B2-NPMX90B-0606	14650-0606	20293191	3/8	3/8-18	7/8	22	1.62	41.2	0.92	23.3	1.97	50.0
B2-NPMX90B-0806	14650-0806	20441228	1/2	3/8-18	7/8	22	2.00	50.7	1.16	29.4	2.41	61.1
B2-NPMX90B-0808	14650-0808	20293192	1/2	1/2-14	1	25	2.15	54.6	1.16	29.4	2.41	61.1
B2-NPMX90B-1212	14650-1212	20293193	3/4	3/4-14	1 1/4	32	2.58	65.6	1.24	31.5	2.80	71.0

NPSM

Female / Swivel



Part Number	Product Number	SAP Number										
			Hose ID	Thread Size (A)	Hex 1 Wrench Size		Hex 2 Wrench Size		Cut-Off (C)		Length (L)	
			in.		in.	mm	in.	mm	in.	mm	in.	mm
B2-NSFX-0404	14655-0404	20242064	1/4	1/4-18	3/4	19	11/16	17	1.19	30.2	2.17	55.1
B2-NSFX-0606	14655-0606	20242065	3/8	3/8-18	7/8	22	3/4	19	1.24	31.4	2.29	58.0
B2-NSFX-0806	14655-0806	20873204	1/2	3/8-18	7/8	22	7/8	22	1.271	32.3	2.518	64.0
B2-NSFX-0808	14655-0808	20242063	1/2	1/2-14	1 1/16	27	7/8	22	1.35	34.3	2.60	66.0
B2-NSFX-0808S	14655-0808S	20424926	1/2	1/2-14	1 1/16	27	7/8	22	1.35	34.3	2.60	66.0
B2-NSFX-1212	14655-1212	20293252	3/4	3/4-14	1 1/4	32	1 3/16	30	1.46	37.0	3.01	76.4
B2-NSFX-1212S	14655-1212S	20955328	3/4	3/4-14	1 1/4	32	1 3/16	30	1.46	37.0	3.01	76.4
B2-NSFX-1616	14655-1616	20293253	1	1-11 1/2	1 1/2	38	1 1/16	36	1.76	44.7	3.54	89.8
B2-NSFX-1616S	14655-1616S	20955329	1	1-11 1/2	1 1/2	38	1 1/16	36	1.76	44.7	3.54	89.8
B2-NSFX-2020	28655-2020	20293263	1 1/4	1 1/4-11 1/2	2	50	1 3/8	41	2.04	51.7	4.08	103.7

S=Stainless Steel (See Fitting Identification in Appendix for more information.)



Download the **MyCrimp App** for more information.

Section 1
B2 Fittings

FITTINGS



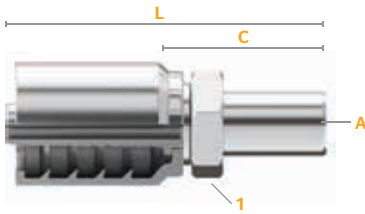

GTF

Female



Part Number	Product Number	SAP Number	Hose ID	Thread Size (A)	Hex 1 Wrench Size	Cut-Off (C)		Length (L)		
			in.		in.	mm	in.	mm	in.	mm
B2-GTF-0404	14370-0404	20293254	1/4	0.511-27	3/4	19	0.92	23.3	1.89	48.2

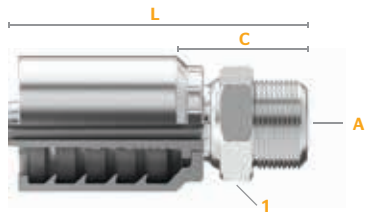

SAE J514 Flareless Tube Fittings

Male



Part Number	Product Number	SAP Number	Hose ID	Thread Size (A)	Hex 1 Wrench Size	Cut-Off (C)		Length (L)		
			in.		in.	mm	in.	mm	in.	mm
B2-FTM-0404	14360-0404	20286101	1/4	7/16-20	1/2	12	0.88	22.2	1.86	47.1
B2-FTM-0405	14360-0405	20294798	1/4	1/2-20	9/16	14	0.90	22.9	1.88	47.8
B2-FTM-0605	14360-0605	20294799	3/8	1/2-20	5/8	16	0.96	24.3	2.01	51.0
B2-FTM-0606	14360-0606	20286102	3/8	9/16-18	5/8	16	0.97	24.7	2.02	51.4
B2-FTM-0608	14360-0608	20661908	3/8	3/4-16	7/8	22	0.97	24.7	2.02	51.4
B2-FTM-0808	14360-0808	20286103	1/2	3/4-16	7/8	22	1.11	28.2	2.36	59.9
B2-FTM-0810	14360-0810	20294860	1/2	7/8-14	15/16	24	1.21	30.7	2.46	62.4
B2-FTM-1212	14360-1212	20294861	3/4	1 1/6-12	1 3/8	30	1.30	33.1	2.85	72.5
B2-FTM-1616	14360-1616	20294862	1	1 3/8-12	1 7/8	36	1.48	37.7	3.26	82.8

All fittings come with nut and sleeve.

FITTINGS



Section 1

B2 Fittings





COMPATIBLE HOSE:

SR1SN	SR2SN	LR16SC	DR16SC	ACP3	SR12
DR1SN	DR2SN	SR16SC	XR16SC	XCP3	ARC12
SFS	LR2SN	ARC16SC	SCP3	XCP4	Hot Oilier

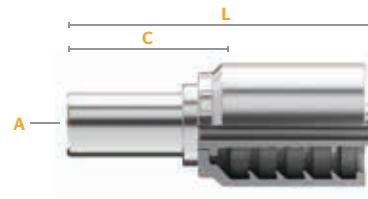
For a detailed list, please refer to your Crimp Specifications Manual.

Standpipe







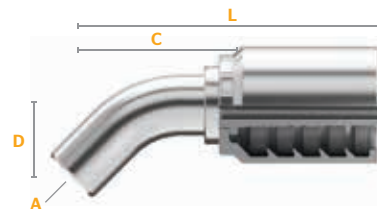

Part Number	Product Number	SAP Number						
			Hose ID	Tube OD (A)	Cut-Off (C)		Length (L)	
			in.	mm	in.	mm	in.	mm
B2-SP-0406	14825-0406	20441305	1/4	6	1.11	28.3	2.09	53.2
B2-SP-0408	14825-0408	20241714	1/4	8	1.19	30.3	2.17	55.2
B2-SP-0410	14825-0410	20241710	1/4	10	1.27	32.3	2.25	57.2
B2-SP-0610	14825-0610	20241712	3/8	10	1.19	30.2	2.24	56.9
B2-SP-0612	14825-0612	20241711	3/8	12	1.15	29.2	2.20	55.9
B2-SP-0815	14825-0815	20241717	1/2	15	1.26	32.0	2.51	63.7
B2-SP-0816	14825-0816	20241716	1/2	16	1.46	37.1	2.71	68.8
B2-SP-1018	14825-1018	20241715	5/8	18	1.35	34.2	2.71	68.7
B2-SP-1020	14825-1020	20241720	5/8	20	1.73	44.0	3.09	78.5
B2-SP-1222	14825-1222	20241713	3/4	22	1.44	36.6	2.99	76.0
B2-SP-1628	14825-1628	20241718	1	28	1.59	40.4	3.37	85.5

All fittings come with nut and sleeve.

Standpipe

45° Elbow



Part Number	Product Number	SAP Number								
			Hose ID	Tube OD (A)	Drop (D)		Cut-Off (C)		Length (L)	
			in.	mm	in.	mm	in.	mm	in.	mm
B2-SP45-0408	14830-0408	20241719	1/4	8	0.91	23.1	1.69	42.9	2.67	67.8



Download the **MyCrimp App** for more information.

Section 1
B2 Fittings





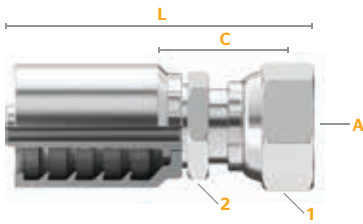

FITTINGS





O-Ring Face Seal (SAE J1453 ORS/ORFS)

Female / Swivel

Part Number	Product Number	SAP Number										
			Hose ID	Thread Size (A)	Hex 1 Wrench Size		Hex 2 Wrench Size		Cut-Off (C)		Length (L)	
			in.		in.	mm	in.	mm	in.	mm	in.	mm
B2-OFFX-0404	14700-0404	20242188	1/4	9/16-18	11/16	17	9/16	14	1.07	27.3	2.05	52.2
B2-OFFX-0406	14700-0406	20242141	1/4	11/16-16	7/8	22	11/16	17	1.19	30.1	2.17	55.0
B2-OFFX-0408	14700-0408	20242148	1/4	13/16-16	15/16	24	7/8	22	1.39	35.4	2.37	60.3
B2-OFFX-0506	14700-0506	20959266	5/16	11/16-16	7/8	22	11/16	17	1.189	30.1	2.169	55.0
B2-OFFX-0604	14700-0604	20293218	3/8	9/16-18	11/16	17	11/16	17	1.12	28.4	2.17	55.1
B2-OFFX-0606	14700-0606	20242196	3/8	11/16-16	7/8	22	11/16	17	1.19	30.3	2.24	56.9
B2-OFFX-0608	14700-0608	20242198	3/8	13/16-16	15/16	24	7/8	22	1.40	35.6	2.45	62.2
B2-OFFX-0806	14700-0806	20242143	1/2	11/16-16	7/8	22	3/4	19	1.26	32.0	2.51	63.7
B2-OFFX-0808	14700-0808	20242149	1/2	13/16-16	15/16	24	7/8	22	1.42	36.1	2.67	67.8
B2-OFFX-0810	14700-0810	20242144	1/2	1-14	1 3/8	30	15/16	24	1.56	39.5	2.80	71.2
B2-OFFX-0812	14700-0812	20242136	1/2	1 3/8-12	1 3/8	36	1 3/8	30	1.66	42.1	2.90	73.8
B2-OFFX-1010	14700-1010	20242178	5/8	1-14	1 3/8	30	15/16	24	1.56	39.6	2.92	74.1
B2-OFFX-1012	14700-1012	20242199	5/8	1 3/8-12	1 3/8	36	1 3/8	30	1.66	42.1	3.01	76.6
B2-OFFX-1210	14700-1210	20242201	3/4	1-14	1 3/8	30	1 3/8	27	1.58	40.1	3.13	79.5
B2-OFFX-1212	14700-1212	20242189	3/4	1 3/8-12	1 3/8	36	1 3/8	30	1.67	42.3	3.22	81.8
B2-OFFX-1216	14700-1216	20242169	3/4	1 7/8-12	1 7/8	41	1 3/8	36	1.92	48.6	3.47	88.1
B2-OFFX-1612	14700-1612	20242159	1	1 3/8-12	1 3/8	36	1 1/4	32	1.79	45.3	3.56	90.4
B2-OFFX-1616	14700-1616	20242142	1	1 7/8-12	1 7/8	41	1 3/8	36	1.95	49.4	3.72	94.5
B2-OFFX-1620	14700-1620	20242164	1	1 7/8-12	2	50	1 3/8	41	1.98	50.3	3.76	95.4
B2-OFFX-2020	28700-2020	20242137	1 1/4	1 7/8-12	2	50	1 3/8	41	2.08	52.9	4.13	104.9
B2-OFFX-2424	28700-2424	20242138	1 1/2	2-12	2 3/8	60	2	50	2.23	56.7	4.56	115.8

FITTINGS



Section 1

B2 Fittings

COMPATIBLE HOSE:

SR1SN	SR2SN	LR16SC	DR16SC	ACP3	SR12
DR1SN	DR2SN	SR16SC	XR16SC	XCP3	ARC12
SFS	LR2SN	ARC16SC	SCP3	XCP4	Hot Oilier

For a detailed list, please refer to your Crimp Specifications Manual.

O-Ring Face Seal (SAE J1453 ORS/ORFS)

Female / 45° Elbow / Swivel

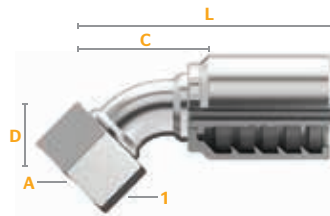

Part Number	Product Number	SAP Number	Hose ID	Thread Size (A)	Hex 1 Wrench Size		Drop (D)		Cut-Off (C)		Length (L)	
			in.		in.	mm	in.	mm	in.	mm	in.	mm
B2-OFFX45-0404	14710-0404	20242231	1/4	9/16-18	11/16	17	0.43	10.9	1.61	41.0	2.59	65.9
B2-OFFX45-0406	14710-0406	20242230	1/4	11/16-16	7/8	22	0.43	10.9	1.81	46.0	2.79	70.9
B2-OFFX45-0606	14710-0606	20242204	3/8	11/16-16	7/8	22	0.47	11.9	1.85	47.0	2.90	73.6
B2-OFFX45-0608	14710-0608	20242206	3/8	13/16-16	15/16	24	0.59	15.0	2.01	51.0	3.06	77.6
B2-OFFX45-0808 ^C	14710-0808	20242228	1/2	13/16-16	15/16	24	0.63	16.0	1.85	47.0	3.10	78.7
B2-OFFX45-0810	14710-0810	20242225	1/2	1-14	1 3/16	30	0.65	16.5	1.97	50.0	3.22	81.7
B2-OFFX45-1010	14710-1010	20242217	5/8	1-14	1 3/16	30	0.67	17.0	2.28	58.0	3.64	92.5
B2-OFFX45-1012	14710-1012	20242207	5/8	1 3/16-12	1 1/16	36	0.83	21.1	2.48	63.0	3.84	97.5
B2-OFFX45-1210	14710-1210	20293219	3/4	1-14	1 3/16	30	0.79	20.1	2.09	53.1	3.64	92.5
B2-OFFX45-1212	14710-1212	20242232	3/4	1 3/16-12	1 1/16	36	0.83	21.0	2.48	63.0	4.03	102.4
B2-OFFX45-1216	14710-1216	20242208	3/4	1 3/16-12	1 5/16	41	0.94	23.9	2.80	71.1	4.35	110.6
B2-OFFX45-1616	14710-1616	20242219	1	1 1/16-12	1 1/2	41	1.02	26.0	3.23	81.9	5.00	127.1
B2-OFFX45-2020	28710-2020	20242223	1 1/4	1 1/16-12	2	50	1.02	25.9	3.82	97.0	5.87	149.0
B2-OFFX45-2024	28710-2024	20242224	1 1/4	2-12	2 3/16	60	1.10	27.9	3.98	101.1	6.03	153.1
B2-OFFX45-2424	28710-2424	20242222	1 1/2	2-12	2 3/16	60	1.10	27.9	4.13	104.9	6.46	164.0

C=Crimp Nut (See Fitting Identification in Appendix for more information.)



Download the **MyCrimp App** for more information.

Section 1
B2 Fittings

FITTINGS



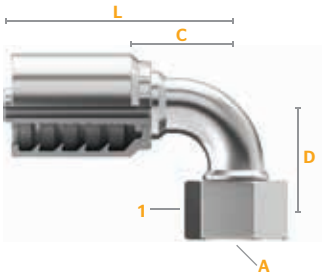

O-Ring Face Seal (SAE J1453 ORS/ORFS)

Female / 90° Elbow / Swivel



Part Number	Product Number	SAP Number	Hose ID	Thread Size (A)	Hex 1 Wrench Size	Elbow Type*	Drop (D)		Cut-Off (C)		Length (L)		
			in.	in.	in.		mm	in.	mm	in.	mm	in.	mm
B2-OFFX90-0404	14715-0404	20242236	1/4	9/16-18	11/16	17		1.26	32.0	1.18	30.0	2.16	54.9
B2-OFFX90L-0404	14720-0404	20242254	1/4	9/16-18	11/16	17	LT	1.81	46.0	1.30	33.0	2.28	57.9
B2-OFFX90S-0404	14725-0404	20242152	1/4	9/16-18	11/16	17	ST	0.83	21.0	1.10	28.0	2.08	52.9
B2-OFFX90-0406	14715-0406	20242243	1/4	11/16-16	7/8	22		1.50	38.0	1.46	37.0	2.44	61.9
B2-OFFX90L-0406	14720-0406	20242250	1/4	11/16-16	7/8	22	LT	2.13	54.0	1.38	35.0	2.36	59.9
B2-OFFX90S-0406	14725-0406	20242151	1/4	11/16-16	7/8	22	ST	0.91	23.0	1.26	32.0	2.24	56.9
B2-OFFX90S-0408	14725-0408	20923065	1/4	13/16-16	15/16	24	ST	1.142	29.0	1.81	46.0	2.79	70.9
B2-OFFX90S-0604	14725-0604	20591895	3/8	9/16-18	11/16	17	ST	0.83	21.0	1.10	28.0	2.15	54.6
B2-OFFX90-0606	14715-0606	20242239	3/8	11/16-16	7/8	22		1.50	38.0	1.65	42.0	2.70	68.6
B2-OFFX90L-0606	14720-0606	20241694	3/8	11/16-16	7/8	22	LT	2.13	54.0	1.65	42.0	2.70	68.6
B2-OFFX90S-0606	14725-0606	20242158	3/8	11/16-16	7/8	22	ST	0.98	25.0	1.65	42.0	2.70	68.6
B2-OFFX90-0608	14715-0608	20242252	3/8	13/16-16	15/16	24		1.61	41.0	1.73	44.0	2.78	70.6
B2-OFFX90L-0608	14720-0608	20241705	3/8	13/16-16	15/16	24	LT	2.52	64.0	1.85	47.0	2.90	73.6
B2-OFFX90S-0608	14725-0608	20242160	3/8	13/16-16	15/16	24	ST	1.14	29.0	1.65	42.0	2.70	68.6
B2-OFFX90S-0806	14725-0806	20441217	1/2	11/16-16	7/8	22	ST	0.98	25.0	1.65	42.0	2.90	73.7
B2-OFFX90-0808 ^c	14715-0808	20241704	1/2	13/16-16	15/16	24		1.65	42.0	1.38	35.0	2.63	66.7
B2-OFFX90L-0808 ^c	14720-0808	20242216	1/2	13/16-16	15/16	24	LT	2.52	64.0	1.50	38.0	2.74	69.7
B2-OFFX90S-0808 ^c	14725-0808	20242226	1/2	13/16-16	15/16	24	ST	1.14	29.0	1.58	40.0	2.82	71.7
B2-OFFX90-0810	14715-0810	20241703	1/2	1-14	1 3/16	30		1.85	47.0	1.89	48.0	3.14	79.7
B2-OFFX90L-0810	14720-0810	20242214	1/2	1-14	1 3/16	30	LT	2.76	70.1	1.81	46.0	3.06	77.6
B2-OFFX90S-0810	14725-0810	20242249	1/2	1-14	1 3/16	30	ST	1.28	32.5	1.81	46.0	3.06	77.6
B2-OFFX90S-0812	14725-0812	20293220	1/2	1 3/16-12	1 3/16	36	ST	2.01	51.1	2.19	55.6	3.44	87.3
B2-OFFX90-1010	14715-1010	20242242	5/8	1-14	1 3/16	30		1.73	44.0	2.17	55.0	3.52	89.5
B2-OFFX90L-1010	14720-1010	20241696	5/8	1-14	1 3/16	30	LT	2.77	70.2	2.17	55.0	3.52	89.5
B2-OFFX90S-1010	14725-1010	20242162	5/8	1-14	1 3/16	30	ST	1.28	32.5	2.05	52.0	3.40	86.5
B2-OFFX90S-1012	14725-1012	20242161	5/8	1 3/16-12	1 3/16	36	ST	1.93	49.0	2.17	55.1	3.53	89.6
B2-OFFX90S-1210	14725-1210	20242167	3/4	1-14	1 3/16	30	ST	1.54	39.1	1.75	44.5	3.30	83.9
B2-OFFX90-1212	14715-1212	20242237	3/4	1 3/16-12	1 3/16	36		2.28	58.0	2.44	62.0	3.99	101.4
B2-OFFX90L-1212	14720-1212	20242255	3/4	1 3/16-12	1 3/16	36	LT	3.78	96.0	2.44	62.0	3.99	101.4
B2-OFFX90S-1212	14725-1212	20242153	3/4	1 3/16-12	1 3/16	36	ST	2.01	51.0	2.40	61.0	3.96	100.5
B2-OFFX90S-1216	14725-1216	20242155	3/4	1 3/16-12	1 3/8	41	ST	2.80	71.1	2.60	66.0	4.15	105.5
B2-OFFX90S-1612	14725-1612	20441218	1	1 3/16-12	1 3/16	36	ST	2.01	51.0	2.43	61.7	4.20	106.8
B2-OFFX90-1616	14715-1616	20241698	1	1 3/16-12	1 3/8	41		2.60	66.0	3.27	83.0	5.04	128.1

Continued on the next page.

FITTINGS



Section 1

B2 Fittings

COMPATIBLE HOSE:

SR1SN	SR2SN	LR16SC	DR16SC	ACP3	SR12
DR1SN	DR2SN	SR16SC	XR16SC	XCP3	ARC12
SFS	LR2SN	ARC16SC	SCP3	XCP4	Hot Oilier

For a detailed list, please refer to your Crimp Specifications Manual.

O-Ring Face Seal (Female 90° Elbow) Continued

Part Number	Product Number	SAP Number	Hose ID	Thread Size (A)	Hex 1 Wrench Size		Elbow Type*	Drop (D)		Cut-Off (C)		Length (L)	
				in.	in.	in.		mm	in.	mm	in.	mm	in.
B2-OFFX90L-1616	14720-1616	20242202	1	1 7/16-12	1 5/8	41	LT	4.49	114.0	3.27	83.0	5.04	128.1
B2-OFFX90S-1616	14725-1616	20242244	1	1 7/16-12	1 5/8	41	ST	2.28	58.0	3.27	83.0	5.04	128.1
B2-OFFX90-1620	14715-1620	20242253	1	1 7/16-12	2	50		3.07	78.0	3.27	83.0	5.04	128.1
B2-OFFX90S-1620	14725-1620	20242235	1	1 7/16-12	2	50	ST	2.52	64.0	3.27	83.0	5.04	128.1
B2-OFFX90-2020	28715-2020	20241702	1 1/4	1 7/16-12	2	50		3.07	78.0	3.82	97.0	5.87	149.0
B2-OFFX90L-2020	28720-2020	20242212	1 1/4	1 7/16-12	2	50	LT	5.08	129.0	3.82	97.0	5.87	149.0
B2-OFFX90S-2020	28725-2020	20242247	1 1/4	1 7/16-12	2	50	ST	2.68	68.1	3.74	95.0	5.79	147.0
B2-OFFX90L-2024	28720-2024	20242213	1 1/4	2-12	2 3/8	60	LT	5.55	141.0	4.02	102.1	6.07	154.1
B2-OFFX90S-2024	28725-2024	20242248	1 1/4	2-12	2 3/8	60	ST	2.72	69.1	4.02	102.1	6.07	154.1
B2-OFFX90-2424	28715-2424	20241701	1 1/2	2-12	2 3/8	60		3.43	87.1	4.25	108.0	6.58	167.1
B2-OFFX90L-2424	28720-2424	20441321	1 1/2	2-12	2 3/8	60	LT	5.55	141.0	4.37	111.0	6.70	170.1
B2-OFFX90S-2424	28725-2424	20242246	1 1/2	2-12	2 3/8	60	ST	3.07	78.0	4.02	102.1	6.35	161.2

C=Crimp Nut (See Fitting Identification in Appendix for more information) *Elbow Type: LT=Long Tube ST=Short Tube

O-Ring Face Seal (SAE J1453 ORS/ORFS)

Male

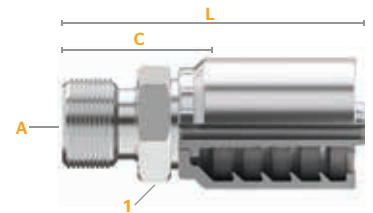

Part Number	Product Number	SAP Number	Hose ID	Thread Size (A)	Hex 1 Wrench Size		Cut-Off (C)		Length (L)	
			in.	in.	in.	mm	in.	mm	in.	mm
B2-OFM-0404	14730-0404	20242187	1/4	9/16-18	11/16	17	1.00	25.4	1.98	50.3
B2-OFM-0406	14730-0406	20441219	1/4	11/16-16	3/4	19	0.96	24.3	1.94	49.1
B2-OFM-0506	14730-0506	20959267	5/16	11/16-16	3/4	19	1.052	26.7	2.03	51.6
B2-OFM-0606	14730-0606	20242181	3/8	11/16-16	3/4	19	1.05	26.7	2.10	53.4
B2-OFM-0608	14730-0608	20242183	3/8	13/16-16	7/8	22	1.05	26.6	2.10	53.2
B2-OFM-0808	14730-0808	20242174	1/2	13/16-16	7/8	22	1.19	30.3	2.44	62.0
B2-OFM-0810	14730-0810	20242173	1/2	1-14	1 1/8	27	1.21	30.7	2.46	62.4
B2-OFM-0812	14730-0812	20242172	1/2	1 3/8-12	1 1/4	32	1.34	34.0	2.59	65.7
B2-OFM-1010	14730-1010	20242186	5/8	1-14	1 1/8	27	1.22	30.9	2.57	65.3
B2-OFM-1012	14730-1012	20242185	5/8	1 3/8-12	1 1/4	32	1.34	34.1	2.70	68.6
B2-OFM-1212	14730-1212	20242177	3/4	1 3/8-12	1 1/4	32	1.36	34.6	2.92	74.1
B2-OFM-1216	14730-1216	20242179	3/4	1 7/8-12	1 5/8	41	1.55	39.3	3.10	78.8
B2-OFM-1616	14730-1616	20242194	1	1 7/8-12	1 1/2	38	1.47	37.4	3.25	82.5
B2-OFM-2020	28730-2020	20242171	1 1/4	1 7/8-12	1 5/8	46	1.64	41.7	3.69	93.7



Download the **MyCrimp App** for more information.

Section 1 B2 Fittings



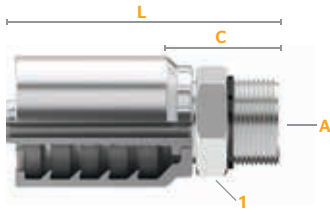

FITTINGS





O-Ring Boss Straight Thread (SAE J514)

Male

Part Number	Product Number	SAP Number								
			Hose ID	Thread Size (A)	Hex 1 Wrench Size	Cut-Off (C)	Length (L)	in.	mm	
B2-OBM-0404	14670-0404	20242133	1/4	7/16-20	9/16	14	0.88	22.3	1.86	47.2
B2-OBM-0405	14670-0405	20242132	1/4	1/2-20	5/8	16	0.88	22.3	1.86	47.2
B2-OBM-0406	14670-0406	20242129	1/4	9/16-18	11/16	17	0.88	22.2	1.86	47.1
B2-OBM-0408	14670-0408	20297678	1/4	3/4-16	7/8	22	0.98	24.9	1.96	49.8
B2-OBM-0606	14670-0606	20242122	3/8	9/16-18	3/4	19	0.94	23.7	1.98	50.4
B2-OBM-0608	14670-0608	20242121	3/8	3/4-16	7/8	22	0.73	18.6	2.04	51.7
B2-OBM-0610	14670-0610	20242117	3/8	7/8-14	1 1/16	27	1.08	27.4	2.13	54.1
B2-OBM-0806	14670-0806	20873205	1/2	9/16-18	13/16	20	0.96	24.4	2.21	56.1
B2-OBM-0808	14670-0808	20242134	1/2	3/4-16	7/8	22	1.01	25.6	2.26	57.3
B2-OBM-0808S	14670-0808S	20424923	1/2	3/4-16	7/8	22	1.01	25.6	2.26	57.3
B2-OBM-0810	14670-0810	20242131	1/2	7/8-14	1 1/8	27	1.10	27.9	2.35	59.6
B2-OBM-0812	14670-0812	20242128	1/2	1 1/8-12	1 1/4	32	1.26	32.1	2.51	63.8
B2-OBM-1008	14670-1008	20293194	5/8	3/4-16	15/16	24	1.04	26.4	2.40	60.8
B2-OBM-1010	14670-1010	20293195	5/8	7/8-14	15/16	24	1.10	27.9	2.46	62.4
B2-OBM-1012	14670-1012	20242123	5/8	1 1/8-12	1 1/4	32	1.27	32.2	2.63	66.7
B2-OBM-1210	14670-1210	20242120	3/4	7/8-14	1 1/8	27	1.13	28.6	2.68	68.0
B2-OBM-1212	14670-1212	20242126	3/4	1 1/8-12	1 1/4	32	1.29	32.7	2.84	72.2
B2-OBM-1216	14670-1216	20242118	3/4	1 3/8-12	1 1/2	38	1.37	34.8	2.92	74.2
B2-OBM-1616	14670-1616	20242127	1	1 5/8-12	1 1/2	38	1.38	35.0	3.15	80.1
B2-OBM-2020	28670-2020	20293258	1 1/4	1 3/8-12	1 3/8	46	1.55	39.3	3.59	91.3
B2-OBM-2424	28670-2424	20307206	1 1/2	1 7/8-12	1 7/8	50	1.60	40.5	3.92	99.7

S=Stainless Steel (See Fitting Identification in Appendix for more information.)

FITTINGS



Section 1

B2 Fittings

COMPATIBLE HOSE:





SR1SN	SR2SN	LR16SC	DR16SC	ACP3	SR12
DR1SN	DR2SN	SR16SC	XR16SC	XCP3	ARC12
SFS	LR2SN	ARC16SC	SCP3	XCP4	Hot Oilier

For a detailed list, please refer to your Crimp Specifications Manual.

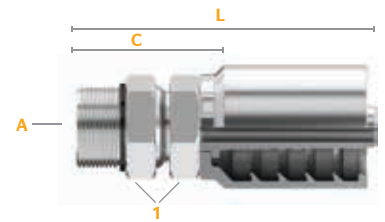
O-Ring Boss Straight Thread (SAE J514)

Male / Swivel







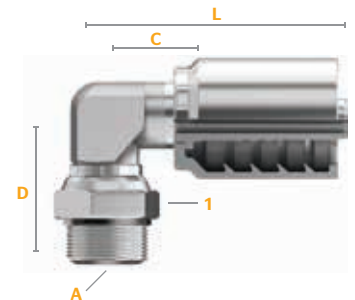

Part Number	Product Number	SAP Number								
			Hose ID	Thread Size (A)	Hex 1 Wrench Size		Cut-Off (C)		Length (L)	
			in.		in.	mm	in.	mm	in.	mm
B2-OBMX-0404	14680-0404	20293196	1/4	7/16-20	11/16	17	1.30	32.9	2.28	57.8
B2-OBMX-0406	14680-0406	20441229	1/4	9/16-18	7/8	22	1.69	43.0	2.67	67.9
B2-OBMX-0606	14680-0606	20293197	3/8	9/16-18	7/8	22	1.61	40.9	2.66	67.5
B2-OBMX-0608	14680-0608	20293198	3/8	3/4-16	1	25	1.73	44.0	2.78	70.6
B2-OBMX-0808	14680-0808	20293199	1/2	3/4-16	1	25	1.68	42.7	2.93	74.4
B2-OBMX-0810	14680-0810	20293200	1/2	7/8-14	1	25	1.69	42.9	2.94	74.6
B2-OBMX-1212	14680-1212	20293201	3/4	1 1/6-12	1 1/4	32	1.97	50.0	3.52	89.4

O-Ring Boss Straight Thread (SAE J514)

Male / 90° Block Elbow / Swivel



Part Number	Product Number	SAP Number										
			Hose ID	Thread Size (A)	Hex 1 Wrench Size		Drop (D)		Cut-Off (C)		Length (L)	
			in.		in.	mm	in.	mm	in.	mm	in.	mm
B2-OBMX90B-0405	14685-0405	20293202	1/4	1/2-20	11/16	17	1.50	38.07	0.71	18.1	1.69	43.0
B2-OBMX90B-0406	14685-0406	20441270	1/4	9/16-18	7/8	22	1.74	44.30	0.80	20.3	1.78	45.2
B2-OBMX90B-0606	14685-0606	20293203	3/8	9/16-18	7/8	22	1.74	44.30	0.92	23.3	1.97	50.0
B2-OBMX90B-0608	14685-0608	20293204	3/8	3/4-16	1	25	2.17	55.02	1.13	28.8	2.18	55.4
B2-OBMX90B-0610	14685-0610	20928905	3/8	7/8-14	1	25	1.91	48.50	1.13	28.8	2.181	55.4
B2-OBMX90B-0808	14685-0808	20293205	1/2	3/4-16	1	25	2.17	55.02	1.16	29.4	2.41	61.1
B2-OBMX90B-0810	14685-0810	20293206	1/2	7/8-14	1	25	2.17	55.19	1.16	29.4	2.41	61.1
B2-OBMX90B-1012	14685-1012	20294829	5/8	1 1/6-12	1 1/4	32	2.58	65.61	1.23	31.3	2.59	65.8
B2-OBMX90B-1212	14685-1212	20293207	3/4	1 1/6-12	1 1/4	32	2.58	65.48	1.24	31.5	2.80	71.0



Download the **MyCrimp App** for more information.

Section 1
B2 Fittings

FITTINGS



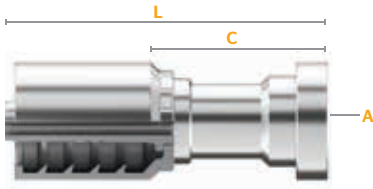

Code 61 Flange (SAE J518)

Part Number	Product Number	SAP Number	Hose ID	Flange Size	Flange Diameter (A)		Cut-Off (C)		Length (L)	
					in.	mm	in.	mm	in.	mm
B2-FL-0808	14320-0808	20242908	1/2	1/2	1.19	30.2	1.61	40.9	2.86	72.6
B2-FL-0812	14320-0812	20242906	1/2	3/4	1.50	38.1	1.65	41.9	2.90	73.6
B2-FL-1012	14320-1012	20242899	5/8	3/4	1.50	38.1	1.60	40.7	3.02	76.6
B2-FL-1212	14320-1212	20242901	3/4	3/4	1.50	38.1	1.67	42.4	3.22	81.9
B2-FL-1216	14320-1216	20242903	3/4	1	1.75	44.5	1.99	50.5	3.54	90.0
B2-FL-1616	14320-1616	20242879	1	1	1.75	44.5	2.02	51.3	3.80	96.4
B2-FL-1620	14320-1620	20242902	1	1 1/4	2.00	50.8	2.12	53.8	3.90	98.9
B2-FL-2020	28320-2020	20242909	1 1/4	1 1/4	2.00	50.8	2.19	55.6	4.24	107.6
B2-FL-2020S	28320-2020S	20933772	1 1/4	1 1/4	2.00	50.8	2.19	55.6	4.24	107.6
B2-FL-2024	28320-2024	20242910	1 1/4	1 1/2	2.37	60.3	2.30	58.5	4.35	110.5
B2-FL-2424	28320-2424	20242886	1 1/2	1 1/2	2.37	60.3	2.31	58.7	4.64	117.8
B2-FL-2424S	28320-2424S	20933773	1 1/2	1 1/2	2.37	60.3	2.31	58.7	4.64	117.8
B2-FL-2432	28320-2432	20242911	1 1/2	2	2.81	71.4	2.76	70.1	5.09	129.2
B2-FL-3232	28320-3232	20242895	2	2	2.81	71.4	2.76	70.0	5.59	142.0
B2-FL-3232S	28320-3232S	20933774	2	2	2.81	71.4	2.76	70.0	5.59	142.0

S=Stainless Steel (See Fitting Identification in Appendix for more information.)

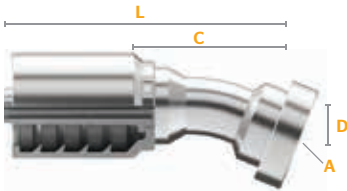

Code 61 Flange (SAE J518)

22.5° Elbow

Part Number	Product Number	SAP Number	Hose ID	Flange Size	Flange Diameter (A)		Drop (D)	Cut-Off (C)		Length (L)		
					in.	mm		in.	mm	in.	mm	
B2-FL22-1616	14330-1616	20242939	1	1	1.75	44.5	0.47	11.9	3.66	93.0	5.44	138.0
B2-FL22-2020	28330-2020	20242928	1 1/4	1 1/4	2.00	50.8	0.63	16.0	4.49	114.0	6.54	166.0
B2-FL22-2024	28330-2024	20293266	1 1/4	1 1/2	2.37	60.3	0.81	20.6	4.53	115.1	6.58	167.0
B2-FL22-2424	28330-2424	20242923	1 1/2	1 1/2	2.37	60.3	0.65	16.5	5.16	131.1	7.49	190.2
B2-FL22-3232	28330-3232	20293267	2	2	2.81	71.4	0.87	22.1	6.02	152.9	8.85	224.9

FITTINGS



Section 1 B2 Fittings

COMPATIBLE HOSE:

SR1SN	SR2SN	LR16SC	DR16SC	ACP3	SR12
DR1SN	DR2SN	SR16SC	XR16SC	XCP3	ARC12
SFS	LR2SN	ARC16SC	SCP3	XCP4	Hot Oilier

For a detailed list, please refer to your Crimp Specifications Manual.

Code 61 Flange (SAE J518)

30° Elbow

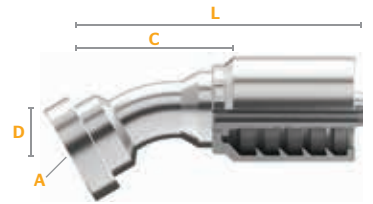

Part Number	Product Number	SAP Number	Hose		Flange		Drop (D)		Cut-Off (C)		Length (L)	
			ID	Size	Diameter (A)		in.	mm	in.	mm	in.	mm
B2-FL30-1616	14335-1616	20242927	1	1	1.75	44.5	0.83	21.1	3.54	89.9	5.32	135.0
B2-FL30-2020	28335-2020	20242922	1 ¼	1 ¼	2.00	50.8	0.98	24.9	4.02	102.1	6.07	154.1
B2-FL30-2024	28335-2024	20242913	1 ¼	1 ½	2.37	60.3	1.06	26.9	4.41	112.0	6.46	164.0
B2-FL30-2424	28335-2424	20242924	1 ½	1 ½	2.37	60.3	0.91	23.1	5.35	135.9	7.68	195.0
B2-FL30-2432	28335-2432	20293269	1 ½	2	2.81	71.4	1.44	36.6	5.91	150.1	8.24	209.2
B2-FL30-3232	28335-3232	20293270	2	2	2.81	71.4	1.18	30.0	5.87	149.1	8.70	221.1

Code 61 Flange (SAE J518)

45° Elbow

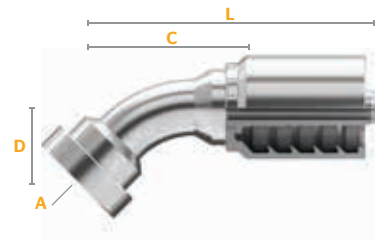

Part Number	Product Number	SAP Number	Hose		Flange		Drop (D)		Cut-Off (C)		Length (L)	
			ID	Size	Diameter (A)		in.	mm	in.	mm	in.	mm
B2-FL45-0808	14340-0808	20242949	1/2	1/2	1.19	30.2	0.87	22.1	2.09	53.1	3.34	84.8
B2-FL45-0812	14340-0812	20242947	1/2	3/4	1.50	38.1	1.02	25.9	2.36	59.9	3.61	91.6
B2-FL45-1212	14340-1212	20242942	3/4	3/4	1.50	38.1	1.26	32.0	2.91	73.9	4.46	113.4
B2-FL45-1216	14340-1216	20242944	3/4	1	1.75	44.5	1.14	29.0	3.07	78.0	4.62	117.4
B2-FL45-1616	14340-1616	20242919	1	1	1.75	44.5	1.32	33.5	3.27	83.1	5.05	128.1
B2-FL45-1620	14340-1620	20242917	1	1 ¼	2.00	50.8	1.42	36.1	3.23	82.0	5.01	127.1
B2-FL45-2020	28340-2020	20242934	1 ¼	1 ¼	2.00	50.8	1.48	37.6	3.74	95.0	5.79	147.0
B2-FL45-2020S	28340-2020S	20933775	1 ¼	1 ¼	2.00	50.8	1.48	37.6	3.74	95.0	5.79	147.0
B2-FL45-2024	28340-2024	20242921	1 ¼	1 ½	2.37	60.3	1.57	39.9	4.09	103.9	6.14	155.9
B2-FL45-2424	28340-2424	20242915	1 ½	1 ½	2.37	60.3	1.89	48.0	4.61	117.1	6.94	176.2
B2-FL45-2424S	28340-2424S	20933776	1 ½	1 ½	2.37	60.3	1.89	48.0	4.61	117.1	6.94	176.2
B2-FL45-2432	28340-2432	20242914	1 ½	2	2.81	71.4	2.19	55.6	5.35	135.9	7.68	195.1
B2-FL45-3232	28340-3232	20242945	2	2	2.81	71.4	1.87	47.5	5.55	141.0	8.38	213.0
B2-FL45-3232S	28340-3232S	20933777	2	2	2.81	71.4	1.87	47.5	5.55	141.0	8.38	213.0

S=Stainless Steel (See Fitting Identification in Appendix for more information.)



Download the **MyCrimp App** for more information.

Section 1 B2 Fittings





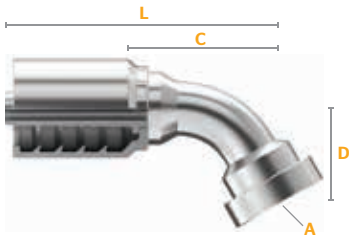

FITTINGS





Code 61 Flange (SAE J518)





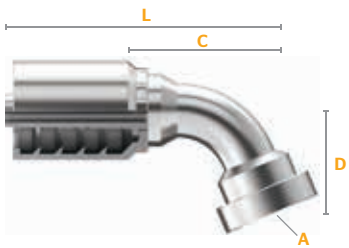

60° Elbow

Part Number	Product Number	SAP Number										
			Hose ID	Flange Size	Flange Diameter (A)		Drop (D)		Cut-Off (C)		Length (L)	
			in.		in.	mm	in.	mm	in.	mm	in.	mm
B2-FL60-1212	14345-1212	20242938	3/4	3/4	1.50	38.1	1.46	37.1	3.39	86.1	4.94	125.6
B2-FL60-1216	14345-1216	20242936	3/4	1	1.75	44.5	1.73	43.9	4.02	102.1	5.66	143.8
B2-FL60-1616	14345-1616	20293255	1	1	1.75	44.5	1.85	47.0	3.98	101.1	5.76	146.2
B2-FL60-2020	28345-2020	20242937	1 ¼	1 ¼	2.00	50.8	2.22	56.4	5.10	129.5	7.15	181.5
B2-FL60-2024	28345-2024	20293271	1 ¼	1 ½	2.37	60.3	2.28	58.0	5.31	134.9	7.36	187.0
B2-FL60-2424	28345-2424	20293272	1 ½	1 ½	2.37	60.3	2.28	57.9	5.31	134.9	7.36	186.8
B2-FL60-2432	28345-2432	20293273	1 ½	2	2.81	71.4	3.05	77.5	6.52	165.6	8.85	224.7
B2-FL60-3232	28345-3232	20293274	2	2	2.81	71.4	3.62	91.9	6.81	173.0	9.64	245.0



Code 61 Flange (SAE J518)

67° Elbow

Part Number	Product Number	SAP Number										
			Hose ID	Flange Size	Flange Diameter (A)		Drop (D)		Cut-Off (C)		Length (L)	
			in.		in.	mm	in.	mm	in.	mm	in.	mm
B2-FL67-1616	14347-1616	20293256	1	1	1.75	44.5	1.95	49.5	3.68	93.5	5.46	138.6
B2-FL67-2020	28347-2020	20293278	1 ¼	1 ¼	2.00	50.8	2.46	62.5	4.72	119.9	6.77	171.9
B2-FL67-2024	28347-2024	20293279	1 ¼	1 ½	2.37	60.3	2.58	65.5	4.78	121.4	6.83	173.5
B2-FL67-2424	28347-2424	20293280	1 ½	1 ½	2.37	60.3	2.58	65.5	5.33	135.4	7.66	194.5
B2-FL67-2432	28347-2432	20293281	1 ½	2	2.81	71.4	3.46	87.9	5.55	141.0	7.88	200.1
B2-FL67-3232	28347-3232	20293282	2	2	2.81	71.4	3.76	95.5	7.05	179.1	9.88	251.1

FITTINGS



Section 1

B2 Fittings

COMPATIBLE HOSE:





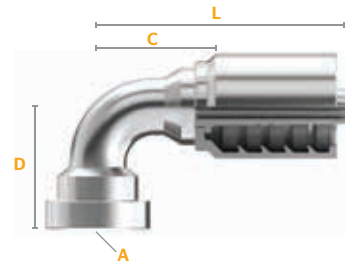

SR1SN	SR2SN	LR16SC	DR16SC	ACP3	SR12
DR1SN	DR2SN	SR16SC	XR16SC	XCP3	ARC12
SFS	LR2SN	ARC16SC	SCP3	XCP4	Hot Oilier

For a detailed list, please refer to your Crimp Specifications Manual.

Code 61 Flange (SAE J518)

90° Elbow







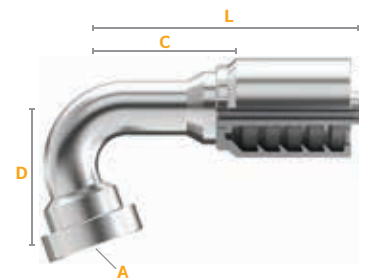

Part Number	Product Number	SAP Number										
			Hose ID	Flange Size	Flange Diameter (A)		Drop (D)		Cut-Off (C)		Length (L)	
			in.		in.	mm	in.	mm	in.	mm	in.	mm
B2-FL90-0808	14350-0808	20242888	1/2	1/2	1.19	30.2	1.65	41.9	1.81	46.0	3.06	77.6
B2-FL90-0812	14350-0812	20242877	1/2	3/4	1.50	38.1	2.01	51.1	1.77	45.0	3.02	76.6
B2-FL90-1212	14350-1212	20242881	3/4	3/4	1.50	38.1	2.36	59.9	2.28	57.9	3.83	97.4
B2-FL90-1216	14350-1216	20242883	3/4	1	1.75	44.5	2.54	64.5	2.60	66.0	4.15	105.5
B2-FL90-1616	14350-1616	20242930	1	1	1.75	44.5	2.64	67.1	2.80	71.1	4.58	116.2
B2-FL90-1620	14350-1620	20242893	1	1 1/4	2.00	50.8	2.80	71.1	2.91	73.9	4.69	119.0
B2-FL90-2016	28350-2016	20242897	1 1/4	1	1.75	44.5	2.56	65.0	3.70	94.0	5.75	146.0
B2-FL90-2020	28350-2020	20242931	1 1/4	1 1/4	2.00	50.8	3.31	84.0	3.46	88.0	5.51	140.0
B2-FL90-2020S	28350-2020S	20933778	1 1/4	1 1/4	2.00	50.8	3.31	84.0	3.46	88.0	5.51	140.0
B2-FL90-2024	28350-2024	20242889	1 1/4	1 1/2	2.37	60.3	3.44	87.4	3.58	90.9	5.63	142.9
B2-FL90-2424	28350-2424	20242891	1 1/2	1 1/2	2.37	60.3	3.58	90.9	4.13	104.9	6.46	164.0
B2-FL90-2424S	28350-2424S	20933779	1 1/2	1 1/2	2.37	60.3	3.58	90.9	4.13	104.9	6.46	164.0
B2-FL90-2432	28350-2432	20242890	1 1/2	2	2.81	71.4	4.53	115.1	4.13	104.9	6.46	164.0
B2-FL90-3232	28350-3232	20242894	2	2	2.81	71.4	5.12	130.0	5.08	129.0	7.91	201.0
B2-FL90-3232S	28350-3232S	20933820	2	2	2.81	71.4	5.12	130.0	5.08	129.0	7.91	201.0

S=Stainless Steel (See Fitting Identification in Appendix for more information.)

Code 61 Flange (SAE J518)

110° Elbow



Part Number	Product Number	SAP Number										
			Hose ID	Flange Size	Flange Diameter (A)		Drop (D)		Cut-Off (C)		Length (L)	
			in.		in.	mm	in.	mm	in.	mm	in.	mm
B2-FL110-2424	28354-2424	20441319	1 1/2	1 1/2	2.37	60.3	4.33	110.0	3.74	95.0	6.06	154.0



Download the **MyCrimp App** for more information.

Section 1
B2 Fittings

FITTINGS



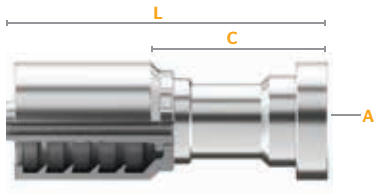

Code 62 Flange (SAE J518)



Part Number	Product Number	SAP Number	Hose ID		Flange Diameter (A)		Cut-Off (C)		Length (L)	
			in.	mm	in.	mm	in.	mm	in.	mm
B2-FH-1212	14300-1212	20241745	3/4	19.0	1.63	41.3	2.07	52.6	3.62	92.0
B2-FH-1616	14300-1616	20242954	1	25.4	1.87	47.6	2.22	56.4	4.00	101.5
B2-FH-1620	14300-1620	20242951	1	25.4	2.13	54.0	2.48	62.9	4.25	108.0
B2-FH-2016	28300-2016	20441292	1 1/4	31.8	1.87	47.6	3.26	82.9	5.31	134.9
B2-FH-2020	28300-2020	20241752	1 1/4	31.8	2.13	54.0	3.27	83.1	5.32	135.0
B2-FH-2024	28300-2024	20241754	1 1/4	31.8	2.50	63.5	2.79	71.0	4.84	122.9
B2-FH-2424	28300-2424	20241751	1 1/2	38.1	2.50	63.5	3.74	95.0	6.07	154.1
B2-FH-2432	28300-2432	20241757	1 1/2	38.1	3.13	79.4	2.99	75.9	5.32	135.1
B2-FH-3232	28300-3232	20241759	2	50.8	3.13	79.4	2.99	75.9	5.82	147.9

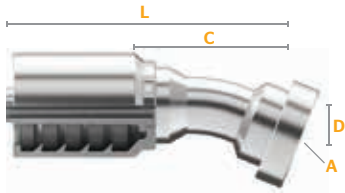

Code 62 Flange (SAE J518)

22.5° Elbow



Part Number	Product Number	SAP Number	Hose ID		Flange Diameter (A)		Drop (D)		Cut-Off (C)		Length (L)	
			in.	mm	in.	mm	in.	mm	in.	mm	in.	mm
B2-FH22-2020	28303-2020	20293291	1 1/4	31.8	2.13	54.0	0.69	17.5	4.72	120.0	6.77	172.0
B2-FH22-2024	28303-2024	20293292	1 1/4	31.8	2.50	63.5	0.81	20.5	5.04	128.0	7.09	180.0

COMPATIBLE HOSE:

SR1SN	SR2SN	LR16SC	DR16SC	ACP3	SR12
DR1SN	DR2SN	SR16SC	XR16SC	XCP3	ARC12
SFS	LR2SN	ARC16SC	SCP3	XCP4	Hot Oiler

For a detailed list, please refer to your Crimp Specifications Manual.

Code 62 Flange (SAE J518)

30° Elbow

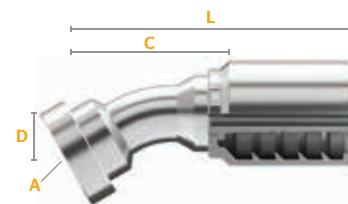

Part Number	Product Number	SAP Number	Hose ID		Flange Size		Flange Diameter (A)		Drop (D)		Cut-Off (C)		Length (L)	
			in.	mm	in.	mm	in.	mm	in.	mm	in.	mm		
B2-FH30-2020	28305-2020	20293295	1 ¼	31.8	1 ¼	31.8	2.13	54.0	0.96	24.4	4.61	117.1	6.66	169.0
B2-FH30-2024	28305-2024	20293296	1 ¼	31.8	1 ½	38.1	2.50	63.5	1.12	28.5	4.90	124.5	6.95	176.5
B2-FH30-2424	28305-2424	20293297	1 ½	38.1	1 ½	38.1	2.50	63.5	1.08	27.4	5.22	132.6	7.55	191.7
B2-FH30-3232	28305-3232	20293298	2	50.8	2	50.8	3.13	79.4	1.44	36.6	6.65	168.9	9.48	240.9

Code 62 Flange (SAE J518)

45° Elbow

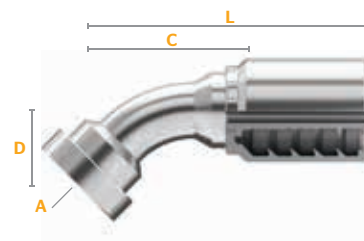

Part Number	Product Number	SAP Number	Hose ID		Flange Size		Flange Diameter (A)		Drop (D)		Cut-Off (C)		Length (L)	
			in.	mm	in.	mm	in.	mm	in.	mm	in.	mm		
B2-FH45-1212	14310-1212	20241791	3/4	19.0	3/4	19.0	1.63	41.3	1.22	31.0	3.31	84.1	4.86	123.5
B2-FH45-1616	14310-1616	20241775	1	25.4	1	25.4	1.87	47.6	1.42	36.1	3.82	97.0	5.60	142.1
B2-FH45-1620	14310-1620	20241772	1	25.4	1 ¼	31.8	2.13	54.0	1.54	39.1	3.78	96.0	5.56	141.1
B2-FH45-2020	28310-2020	20241764	1 ¼	31.8	1 ¼	31.8	2.13	54.0	1.57	40.0	4.29	109.0	6.34	161.0
B2-FH45-2024	28310-2024	20241765	1 ¼	31.8	1 ½	38.1	2.50	63.5	1.79	45.5	4.53	115.1	6.58	167.0
B2-FH45-2424	28310-2424	20241769	1 ½	38.1	1 ½	38.1	2.50	63.5	1.77	45.0	4.84	122.9	7.17	182.1
B2-FH45-2432	28310-2432	20241776	1 ½	38.1	2	50.8	3.13	79.4	2.26	57.4	5.24	133.1	7.57	192.2
B2-FH45-3232	28310-3232	20241767	2	50.8	2	50.8	3.13	79.4	2.36	59.9	6.18	157.0	9.01	229.0



Download the **MyCrimp App** for more information.

Section 1
B2 Fittings





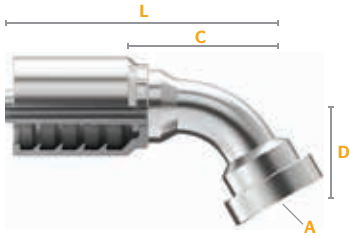

FITTINGS





Code 62 Flange (SAE J518)





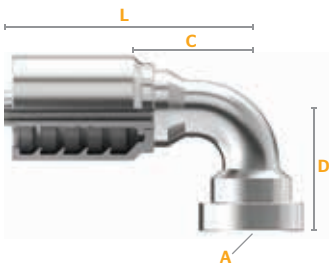

60° Elbow

Part Number	Product Number	SAP Number										
			Hose ID	Flange Size	Flange Diameter (A)		Drop (D)		Cut-Off (C)		Length (L)	
			in.		in.	mm	in.	mm	in.	mm	in.	mm
B2-FH60-2020	28312-2020	20293301	1 ¼	1 ¼	2.13	54.0	2.32	58.9	5.26	133.6	7.30	185.5
B2-FH60-2024	28312-2024	20293302	1 ¼	1 ½	2.50	63.5	2.48	63.0	5.49	139.5	7.54	191.5







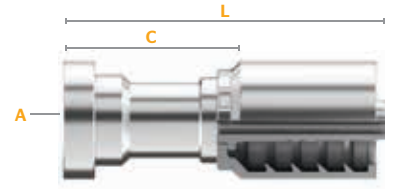

Code 62 Flange (SAE J518)

90° Elbow

Part Number	Product Number	SAP Number										
			Hose ID	Flange Size	Flange Diameter (A)		Drop (D)		Cut-Off (C)		Length (L)	
			in.		in.	mm	in.	mm	in.	mm	in.	mm
B2-FH90-0808	14315-0808	20241744	1/2	1/2	1.25	31.8	1.81	46.0	1.89	48.0	3.32	84.3
B2-FH90-1212	14315-1212	20241732	3/4	3/4	1.63	41.3	2.40	61.0	2.48	63.0	4.03	102.4
B2-FH90-1616	14315-1616	20241788	1	1	1.87	47.6	2.95	74.9	2.91	73.9	4.69	119.0
B2-FH90-1620	14315-1620	20241785	1	1 ¼	2.13	54.0	3.07	78.0	3.07	78.0	4.85	123.1
B2-FH90-2016	28315-2016	20441315	1 ¼	1	1.87	47.6	2.83	71.9	3.35	85.1	5.40	137.0
B2-FH90-2020	28315-2020	20241780	1 ¼	1 ¼	2.13	54.0	3.50	89.0	3.70	94.0	5.75	146.0
B2-FH90-2024	28315-2024	20241781	1 ¼	1 ½	2.50	63.5	3.70	94.0	3.86	98.0	5.91	150.0
B2-FH90-2424	28315-2424	20241771	1 ½	1 ½	2.50	63.5	4.13	104.9	3.94	100.1	6.27	159.2
B2-FH90-2432	28315-2432	20241777	1 ½	2	3.13	79.4	4.84	122.9	4.53	115.1	6.86	174.2
B2-FH90-3232	28315-3232	20241740	2	2	3.13	79.4	5.20	132.1	5.63	143.0	8.46	215.0

Caterpillar® Flange







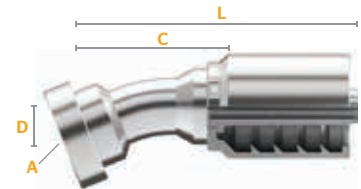

Part Number	Product Number	SAP Number								
			Hose ID	Flange Size	Flange Diameter (A)		Cut-Off (C)		Length (L)	
			in.		in.	mm	in.	mm	in.	mm
B2-CF-2020	28185-2020	20441206	1 ¼	1 ¼	2.13	54.0	3.43	87.0	5.47	139.0
B2-CF-2024	28185-2024	20441279	1 ¼	1 ½	2.50	63.5	3.58	91.0	5.63	143.0
B2-CF-2424	28185-2424	20293307	1 ½	1 ½	2.50	63.5	3.31	84.0	5.63	143.0
B2-CF-2432	28185-2432	20441323	1 ½	2	3.13	79.4	3.86	98.0	6.18	157.0
B2-CF-3232	28185-3232	20293308	2	2	3.13	79.4	4.33	110.0	7.17	182.0

Caterpillar® Flange

22.5° Elbow







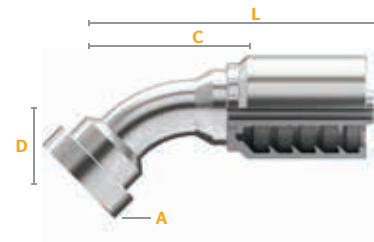

Part Number	Product Number	SAP Number										
			Hose ID	Flange Size	Flange Diameter (A)		Drop (D)		Cut-Off (C)		Length (L)	
			in.		in.	mm	in.	mm	in.	mm	in.	mm
B2-CF22-2020	28187-2020	20441307	1 ¼	1 ¼	2.13	54.0	0.77	19.5	4.80	122.0	6.85	174.0
B2-CF22-2024	28187-2024	20441281	1 ¼	1 ½	2.50	63.5	0.91	23.0	5.12	130.0	7.17	182.0

Caterpillar® Flange

45° Elbow



Part Number	Product Number	SAP Number										
			Hose ID	Flange Size	Flange Diameter (A)		Drop (D)		Cut-Off (C)		Length (L)	
			in.		in.	mm	in.	mm	in.	mm	in.	mm
B2-CF45-2020	28190-2020	20441285	1 ¼	1 ¼	2.13	54.0	1.69	43.0	4.33	110.0	6.38	162.0
B2-CF45-2024	28190-2024	20441286	1 ¼	1 ½	2.50	63.5	1.95	49.5	4.57	116.0	6.61	168.0
B2-CF45-2424	28190-2424	20441325	1 ½	1 ½	2.50	63.5	1.89	48.0	7.01	178.0	9.33	237.0



Download the **MyCrimp App** for more information.

Section 1
B2 Fittings

FITTINGS



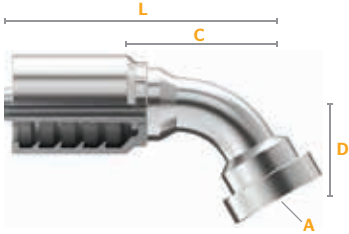

Caterpillar® Flange

60° Elbow



Part Number	Product Number	SAP Number	Hose ID	Flange Size	Flange Diameter (A)		Drop (D)		Cut-Off (C)		Length (L)	
			in.		in.	mm	in.	mm	in.	mm	in.	mm
B2-CF60-2020	28192-2020	20441289	1 ¼	1 ¼	2.13	54.0	2.52	64.0	5.2	132.0	7.24	184.0
B2-CF60-2024	28192-2024	20441290	1 ¼	1 ½	2.50	63.5	2.76	70.0	5.35	136.0	7.40	188.0
B2-CF60-2432	28192-2432	20441326	1 ½	2	3.13	79.4	3.35	85.0	5.47	139.0	7.80	198.0

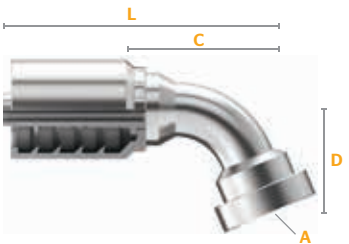

Caterpillar® Flange

67° Elbow



Part Number	Product Number	SAP Number	Hose ID	Flange Size	Flange Diameter (A)		Drop (D)		Cut-Off (C)		Length (L)	
			in.		in.	mm	in.	mm	in.	mm	in.	mm
B2-CF67-2020	28194-2020	20441327	1 ¼	1 ¼	2.13	54.0	2.76	70.0	4.92	125.0	6.97	177.0
B2-CF67-2024	28194-2024	20441328	1 ¼	1 ½	2.50	63.5	3.07	78.0	5.04	128.0	7.09	180.0

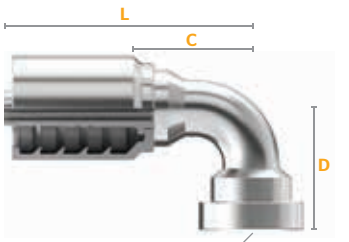

Caterpillar® Flange

90° Elbow



Part Number	Product Number	SAP Number	Hose ID	Flange Size	Flange Diameter (A)		Drop (D)		Cut-Off (C)		Length (L)	
			in.		in.	mm	in.	mm	in.	mm	in.	mm
B2-CF90-2020	28195-2020	20441274	1 ¼	1 ¼	2.13	54.0	3.66	93.0	3.62	92.0	5.67	144.0
B2-CF90-2024	28195-2024	20441275	1 ¼	1 ½	2.50	63.5	3.98	101.0	3.70	94.0	5.75	146.0
B2-CF90-2424	28195-2424	20441332	1 ½	1 ½	2.50	63.5	4.29	109.0	4.41	112.0	6.73	171.0

FITTINGS



Section 1

B2 Fittings





COMPATIBLE HOSE:

SR1SN	SR2SN	LR16SC	DR16SC	ACP3	SR12
DR1SN	DR2SN	SR16SC	XR16SC	XCP3	ARC12
SFS	LR2SN	ARC16SC	SCP3	XCP4	Hot Oilier

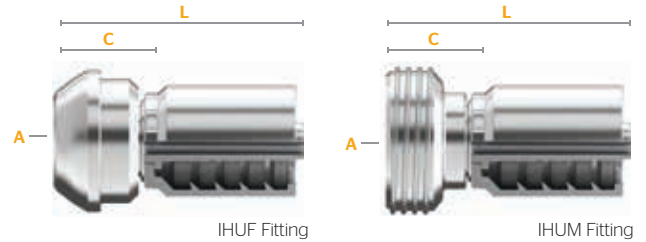
For a detailed list, please refer to your Crimp Specifications Manual.





Hammer Union

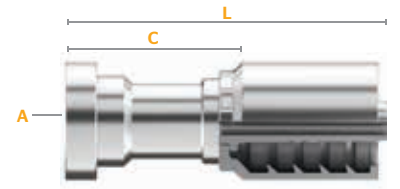

Part Number	Product Number	SAP Number						
			Hose ID	Thread Size (A)	Cut-Off (C)		Length (L)	
			in.		in.	mm	in.	mm
B2-IHUF1502-1616	14390-1616	20873149	1	ACME-2G, 3.5 TPI	2.14	54.4	3.91	99.3
B2-IHUM1502-1616	14395-1616	20873150	1	ACME-2G, 3.5 TPI	2.10	53.3	3.88	98.6
B2-IHUF1502-2432	28390-2432	20815350	1 ½	ACME-2G, 3 TPI	2.64	67.1	4.81	122.2
B2-IHUM1502-2432	28395-2432	20815351	1 ½	ACME-2G, 3 TPI	2.38	60.5	4.88	123.9

Komatsu® Flange







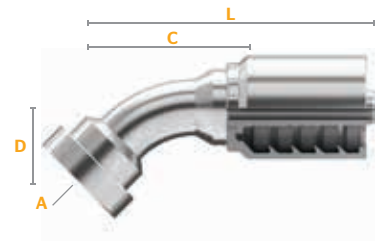

Part Number	Product Number	SAP Number								
			Hose ID	Flange Size	Flange Diameter (A)		Cut-Off (C)		Length (L)	
			in.		in.	mm	in.	mm	in.	mm
B2-KF-0810	14530-0810	20293257	1/2	5/8	1.34	34.0	1.83	46.6	3.08	78.2
B2-KF-1010	14530-1010	20242060	5/8	5/8	1.34	34.0	1.843	46.8	3.20	81.3

Komatsu® Flange

45° Elbow



Part Number	Product Number	SAP Number										
			Hose ID	Flange Size	Flange Diameter (A)		Drop (D)		Cut-Off (C)		Length (L)	
			in.		in.	mm	in.	mm	in.	mm	in.	mm
B2-KF45-1010	14535-1010	20242061	5/8	5/8	1.34	34.0	0.98	24.9	2.32	58.9	3.68	93.4



Download the **MyCrimp App** for more information.

Section 1
B2 Fittings





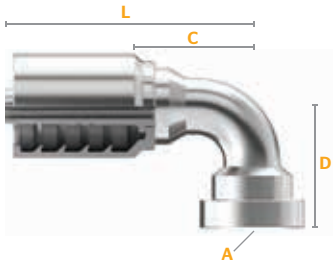

FITTINGS





Komatsu® Flange



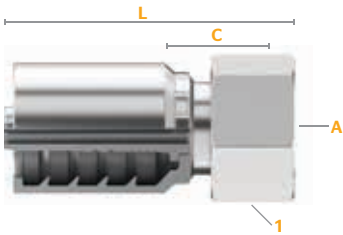

90° Elbow

Part Number	Product Number	SAP Number							
			Hose ID	Flange Size	Flange Diameter (A)	Drop (D)	Cut-Off (C)	Length (L)	
			in.		in. mm	in. mm	in. mm	in.	mm
B2-KF90-1010	14540-1010	20242062	5/8	5/8	1.34 34.0	2.01 51.1	1.97 50.0	3.327	84.5



BSPP (British Standard Pipe Parallel)

Female / Swivel

Part Number	Product Number	SAP Number						
			Hose ID	Thread Size (A)	Hex 1 Wrench Size	Cut-Off (C)	Length (L)	
			in.		mm	in. mm	in.	mm
B2-BPFX-0404	14105-0404	20242821	1/4	1/4-19	19	0.93 23.7	1.91	48.6
B2-BPFX-0406	14105-0406	20242820	1/4	3/8-19	22	1.09 27.6	2.07	52.5
B2-BPFX-0606	14105-0606	20242834	3/8	3/8-19	22	1.09 27.8	2.14	54.4
B2-BPFX-0608	14105-0608	20242822	3/8	1/2-14	27	1.20 30.4	2.24	57.0
B2-BPFX-0808	14105-0808	20242826	1/2	1/2-14	27	1.22 31.0	2.47	62.7
B2-BPFX-0810	14105-0810	20242823	1/2	5/8-14	27	1.48 37.6	2.73	69.3
B2-BPFX-1010 ^C	14105-1010	20242824	5/8	5/8-14	27	1.12 28.5	2.48	62.9
B2-BPFX-1012	14105-1012	20242839	5/8	3/4-14	32	1.49 37.8	2.84	72.2
B2-BPFX-1212 ^C	14105-1212	20242818	3/4	3/4-14	32	1.17 29.7	2.72	69.1
B2-BPFX-1616 ^C	14105-1616	20242862	1	1-11	38	1.36 34.4	3.13	79.5
B2-BPFX-2020 ^T	28105-2020	20242842	1 1/4	1 1/4-11	50	1.69 42.8	3.73	94.8
B2-BPFX-2424 ^T	28105-2424	20242860	1 1/2	1 1/2-11	55	1.80 45.8	4.13	105.0
B2-BPFX-3232 ^T	28105-3232	20242819	2	2-11	70	1.98 50.2	4.81	122.2

C=Crimp Nut T=Thrust-Wire Nut (See Fitting Identification in Appendix for more information.)

FITTINGS



Section 1

B2 Fittings

COMPATIBLE HOSE:





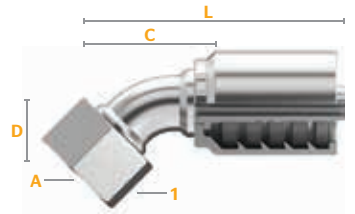

SR1SN	SR2SN	LR16SC	DR16SC	ACP3	SR12
DR1SN	DR2SN	SR16SC	XR16SC	XCP3	ARC12
SFS	LR2SN	ARC16SC	SCP3	XCP4	Hot Oilier

For a detailed list, please refer to your Crimp Specifications Manual.

BSPB (British Standard Pipe Parallel)

Female / 45° Elbow / Swivel







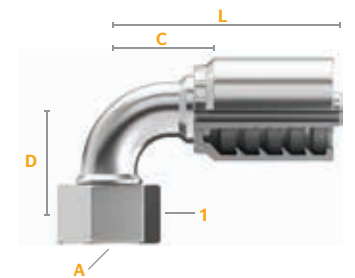

Part Number	Product Number	SAP Number									
			Hose ID	Thread Size (A)	Hex 1 Wrench Size	Drop (D)	Cut-Off (C)	Length (L)			
			in.		mm	in.	mm	in.	mm	in.	mm
B2-BPFX45-0404 ^S	14115-0404	20242851	1/4	1/4-19	19	0.59	15.0	1.81	46.0	2.79	70.9
B2-BPFX45-0606 ^S	14115-0606	20242847	3/8	3/8-19	22	0.81	20.6	1.97	50.0	3.02	76.7
B2-BPFX45-0808 ^S	14115-0808	20242853	1/2	1/2-14	27	0.83	21.1	2.17	55.1	3.42	86.8
B2-BPFX45-1010	14115-1010	20242846	5/8	5/8-14	27	0.85	21.6	2.52	64.0	3.88	98.5
B2-BPFX45-1212	14115-1212	20242849	3/4	3/4-14	32	1.10	27.9	2.76	70.1	4.31	109.6
B2-BPFX45-1616	14115-1616	20242850	1	1-11	38	1.34	34.0	3.31	84.1	5.09	129.2
B2-BPFX45-2020 ^T	28115-2020	20242854	1 1/4	1 1/4-11	50	1.57	39.9	3.98	101.1	6.03	153.1
B2-BPFX45-2424 ^T	28115-2424	20242855	1 1/2	1 1/2-11	55	1.81	46.0	4.57	116.1	6.90	175.2
B2-BPFX45-3232 ^T	28115-3232	20242841	2	2-11	70	2.36	59.9	5.98	151.9	8.81	223.9

T=Thrust-Wire Nut S=Slip Nut (See Fitting Identification in Appendix for more information.)

BSPB (British Standard Pipe Parallel)

Female / 90° Elbow / Swivel



Part Number	Product Number	SAP Number									
			Hose ID	Thread Size (A)	Hex 1 Wrench Size	Drop (D)	Cut-Off (C)	Length (L)			
			in.		mm	in.	mm	in.	mm	in.	mm
B2-BPFX90-0404	14120-0404	20242868	1/4	1/4-19	19	1.14	29.0	1.14	29.0	2.12	53.8
B2-BPFX90-0606	14120-0606	20242864	3/8	3/8-19	22	1.65	41.9	1.38	35.1	2.43	61.7
B2-BPFX90-0608	14120-0608	20242859	3/8	1/2-14	27	1.40	35.6	1.34	34.0	2.39	60.7
B2-BPFX90-0808	14120-0808	20242870	1/2	1/2-14	27	1.61	40.9	1.42	36.1	2.67	67.7
B2-BPFX90-1010 ^C	14120-1010	20242863	5/8	5/8-14	27	1.85	47.0	1.89	48.0	3.25	82.5
B2-BPFX90-1212 ^C	14120-1212	20242866	3/4	3/4-14	32	2.09	53.1	1.93	49.0	3.48	88.5
B2-BPFX90-1616 ^C	14120-1616	20242845	1	1-11	38	2.72	69.1	2.95	74.9	4.73	120.0
B2-BPFX90-2020 ^T	28120-2020	20242848	1 1/4	1 1/4-11	50	3.27	83.1	3.23	82.0	5.28	134.1
B2-BPFX90-2424 ^T	28120-2424	20242843	1 1/2	1 1/2-11	55	3.78	96.0	3.78	96.0	6.11	155.1
B2-BPFX90-3232 ^T	28120-3232	20242867	2	2-11	70	5.35	135.9	5.04	128.0	7.87	200.0

C=Crimp Nut T=Thrust-Wire Nut (See Fitting Identification in Appendix for more information.)



Download the **MyCrimp App** for more information.

Section 1
B2 Fittings



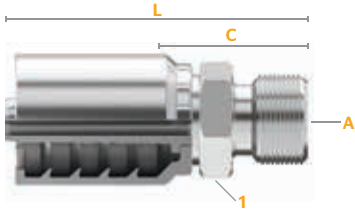

FITTINGS





BSPP (British Standard Pipe Parallel)



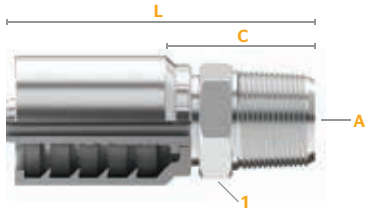

Male

Part Number	Product Number	SAP Number							
			Hose ID	Thread Size (A)	Hex 1 Wrench Size	Cut-Off (C)		Length (L)	
			in.		mm	in.	mm	in.	mm
B2-BPM-0404	14130-0404	20242840	1/4	1/4-19	19	1.03	26.2	2.01	51.1
B2-BPM-0606	14130-0606	20242829	3/8	3/8-19	22	1.10	28.0	2.15	54.6
B2-BPM-0608	14130-0608	20242830	3/8	1/2-14	27	1.24	31.5	2.29	58.1
B2-BPM-0806	14130-0806	20242835	1/2	3/8-19	22	1.12	28.5	2.37	60.2
B2-BPM-0808	14130-0808	20242827	1/2	1/2-14	27	1.26	32.0	2.51	63.7
B2-BPM-1010	14130-1010	20242828	5/8	5/8-14	30	1.35	34.3	2.71	68.8
B2-BPM-1212	14130-1212	20242832	3/4	3/4-14	32	1.45	36.7	3.00	76.1
B2-BPM-1616	14130-1616	20242838	1	1-11	41	1.69	43.0	3.47	88.1
B2-BPM-2020	28130-2020	20242836	1 1/4	1 1/4-11	50	1.89	48.0	3.40	86.3
B2-BPM-2424	28130-2424	20242837	1 1/2	1 1/2-11	55	2.00	50.7	4.33	109.9
B2-BPM-3232	28130-3232	20242833	2	2-11	70	2.28	57.9	5.11	129.8



BSPT (British Standard Pipe Tapered)





Male

Part Number	Product Number	SAP Number							
			Hose ID	Thread Size (A)	Hex 1 Wrench Size	Cut-Off (C)		Length (L)	
			in.		mm	in.	mm	in.	mm
B2-BTM-0404	14170-0404	20242873	1/4	1/4-19	17	1.063	27.0	2.043	51.9
B2-BTM-0406	14170-0406	20923068	1/4	3/8-19	19	1.092	27.7	2.072	52.6
B2-BTM-0606	14170-0606	20242872	3/8	3/8-19	19	1.1	27.9	2.148	54.6
B2-BTM-0608	14170-0608	20923069	3/8	1/2-14	22	1.284	32.5	2.333	59.2
B2-BTM-0808	14170-0808	20242871	1/2	1/2-14	22	1.305	33.1	2.552	64.8
B2-BTM-1212	14170-1212	20242876	3/4	3/4-14	27	1.364	34.6	2.917	74.1
B2-BTM-1616	14170-1616	20242874	1	1-11	36	1.73	43.9	3.505	89.0

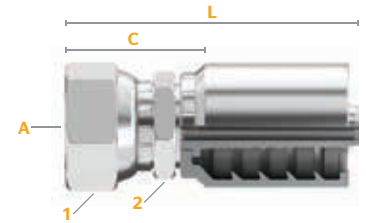
BSP Flat Seat (British Standard Pipe)

Female / Swivel







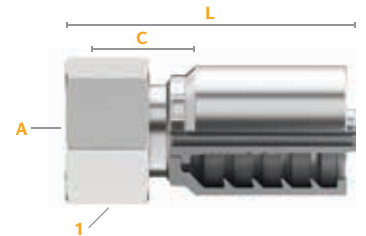

Part Number	Product Number	SAP Number							
			Hose ID	Thread Size (A)	Hex 1 Wrench Size	Cut-Off (C)		Length (L)	
			in.		mm	in.	mm	in.	mm
B2-BFFX-0606	14100-0606	20242815	3/8	3/8-19	22	0.75	19.0	1.80	45.6
B2-BFFX-0608	14100-0608	20242814	3/8	1/2-14	27	0.80	20.2	1.84	46.8
B2-BFFX-0808	14100-0808	20242816	1/2	1/2-14	27	0.82	20.9	2.07	52.5
B2-BFFX-0812	14100-0812	20242812	1/2	3/4-14	32	0.97	24.5	2.21	56.2
B2-BFFX-1212 ^c	14100-1212	20242813	3/4	3/4-14	32	0.72	18.2	2.27	57.6

C=Crimp Nut (See Fitting Identification in Appendix for more information.)

DIN 24° Light

Female / Swivel



Part Number	Product Number	SAP Number							
			Hose ID	Thread Size (A)	Hex 1 Wrench Size	Cut-Off (C)		Length (L)	
			in.		mm	in.	mm	in.	mm
B2-DLFX-0412 ^T	14240-0412	20241852	1/4	12x1.5	14	1.07	27.2	2.05	52.0
B2-DLFX-0414	14240-0414	20241837	1/4	14x1.5	17	1.02	25.9	2.00	50.8
B2-DLFX-0416	14240-0416	20241845	1/4	16x1.5	19	1.08	27.4	2.06	52.2
B2-DLFX-0516	14240-0516	20873166	5/16	16x1.5	19	1.167	29.7	2.147	54.6
B2-DLFX-0518	14240-0518	20873167	5/16	18x1.5	22	1.082	27.4	2.062	52.2
B2-DLFX-0616	14240-0616	20241842	3/8	16x1.5	19	2.21	56.2	2.26	57.5
B2-DLFX-0618	14240-0618	20241843	3/8	18x1.5	22	1.08	27.5	2.13	54.2
B2-DLFX-0622	14240-0622	20782409	3/8	22x1.5		1.18	30.0	2.23	56.7
B2-DLFX-0822	14240-0822	20241859	1/2	22x1.5	27	1.21	30.7	2.46	62.4
B2-DLFX-1026	14240-1026	20241844	5/8	26x1.5	32	1.24	31.5	2.60	65.9
B2-DLFX-1230	14240-1230	20241840	3/4	30x2.0	36	1.42	36.0	2.97	75.4
B2-DLFX-1636	14240-1636	20241871	1	36x2.0	41	1.49	37.9	3.27	83.0
B2-DLFX-2045	28240-2045	20241857	1 1/4	45x2.0	50	1.74	44.1	3.78	96.1
B2-DLFX-2452	28240-2452	20441314	1 1/2	52x2.0	60	1.74	44.1	4.07	103.3

T=Thrust-Wire Nut (See Fitting Identification in Appendix for more information.)



Download the **MyCrimp App** for more information.

Section 1
B2 Fittings





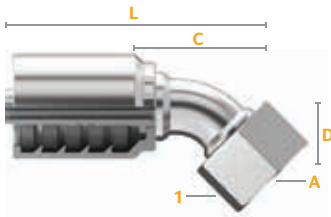

FITTINGS





DIN 24° Light





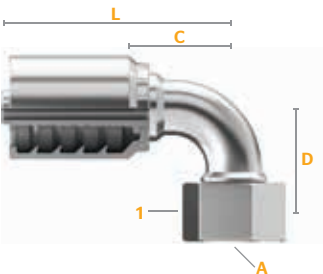

Female / 45° Elbow / Swivel

Part Number	Product Number	SAP Number									
			Hose ID	Thread Size (A)	Hex 1 Wrench Size	Drop (D)	in.	mm	in.	mm	in.
B2-DLFX45-0414	14245-0414	20241855	1/4	14x1.5	17	0.69	17.5	1.69	42.9	2.67	67.8
B2-DLFX45-0416	14245-0416	20241860	1/4	16x1.5	19	0.79	20.1	1.65	41.9	2.63	66.8
B2-DLFX45-0516	14245-0516	20873168	5/16	16x1.5	19	0.71	18.0	1.69	42.9	2.67	67.8
B2-DLFX45-0518	14245-0518	20873169	5/16	18x1.5	22	0.77	19.6	1.848	47.0	2.828	71.9
B2-DLFX45-0616	14245-0616	20441216	3/8	16x1.5	19	0.71	18.0	1.73	43.9	2.78	70.6
B2-DLFX45-0618	14245-0618	20241862	3/8	18x1.5	22	0.77	19.6	1.85	47.0	2.90	73.6
B2-DLFX45-0622	14245-0622	20782411	3/8	22x1.5		0.83	21.1	2.14	54.5	3.19	81.1
B2-DLFX45-0822	14245-0822	20241858	1/2	22x1.5	27	0.83	21.1	2.17	55.1	3.42	86.8
B2-DLFX45-1026	14245-1026	20241863	5/8	26x1.5	32	0.94	23.9	2.56	65.0	3.92	99.5
B2-DLFX45-1230	14245-1230	20241861	3/4	30x2.0	36	1.26	32.0	2.72	69.1	4.27	108.5
B2-DLFX45-1636	14245-1636	20241856	1	36x2.0	41	1.26	32.0	3.58	90.9	5.36	136.0
B2-DLFX45-2452	28245-2452	20588801	1 1/2	52x2.0	60	1.85	47.0	4.49	114.0	6.816	173.1



DIN 24° Light

Female / 90° Elbow / Swivel

Part Number	Product Number	SAP Number									
			Hose ID	Thread Size (A)	Hex 1 Wrench Size	Drop (D)	in.	mm	in.	mm	in.
B2-DLFX90-0412	14250-0412	20241866	1/4	12x1.5	14	1.02	25.9	1.14	29.0	2.12	53.8
B2-DLFX90-0414	14250-0414	20241867	1/4	14x1.5	17	1.28	32.5	1.10	27.9	2.08	52.8
B2-DLFX90-0416	14250-0416	20241868	1/4	16x1.5	19	1.28	32.5	1.10	27.9	2.08	52.8
B2-DLFX90-0516	14250-0516	20873170	5/16	16x1.5	19	1.38	35.1	1.3	33.0	2.28	57.9
B2-DLFX90-0518	14250-0518	20873171	5/16	18x1.5	22	1.54	39.1	1.3	33.0	2.278	57.9
B2-DLFX90-0616	14250-0616	20289910	3/8	16x1.5	19	1.42	36.1	1.18	30.0	2.23	56.6
B2-DLFX90-0618	14250-0618	20241870	3/8	18x1.5	22	1.54	39.1	1.30	33.0	2.35	59.7
B2-DLFX90-0622	14250-0622	20782412	3/8	22x1.5		1.59	40.4	1.54	39.2	2.59	65.9
B2-DLFX90-0822	14250-0822	20241865	1/2	22x1.5	27	1.59	40.4	1.57	39.9	2.82	71.6
B2-DLFX90-1026	14250-1026	20241853	5/8	26x1.5	32	1.89	48.0	2.01	51.1	3.37	85.5
B2-DLFX90-1230	14250-1230	20241869	3/4	30x2.0	36	2.32	58.9	2.05	52.1	3.60	91.5

Continued on the next page.

FITTINGS



Section 1

B2 Fittings

COMPATIBLE HOSE:

SR1SN	SR2SN	LR16SC	DR16SC	ACP3	SR12
DR1SN	DR2SN	SR16SC	XR16SC	XCP3	ARC12
SFS	LR2SN	ARC16SC	SCP3	XCP4	Hot Oilier

For a detailed list, please refer to your Crimp Specifications Manual.

DIN 24° Light (Female 90°) Continued

Part Number	Product Number	SAP Number	Hose ID	Thread Size (A)	Hex 1 Wrench Size	Drop (D)		Cut-Off (C)		Length (L)	
						in.	mm	in.	mm	in.	mm
B2-DLFX90-1636	14250-1636	20241864	1	36x2.0	41	2.68	68.1	3.07	78.0	4.85	123.1
B2-DLFX90-2045	28250-2045	20241872	1 ¼	45x2.0	50	3.50	88.9	3.54	89.9	5.59	141.9
B2-DLFX90-2452	28250-2452	20588800	1 ½	52x2.0	60	3.84	97.5	4.21	107.0	6.54	166.1
B2-DLFX90XL-2452	28250-2452XL	20793531	1 ½	52x2.0	60	8.50	215.9	4.11	104.4	6.60	167.7

DIN 24° Light

Male

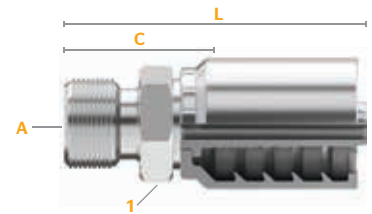

Part Number	Product Number	SAP Number	Hose ID	Thread Size (A)	Hex 1 Wrench Size	Cut-Off (C)		Length (L)	
						in.	mm	in.	mm
B2-DLM-0412	14255-0412	20241847	1/4	12x1.5	14	0.84	21.4	1.82	46.3
B2-DLM-0414	14255-0414	20241848	1/4	14x1.5	14	0.84	21.4	1.82	46.3
B2-DLM-0416	14255-0416	20241849	1/4	16x1.5	17	0.92	23.4	1.90	48.3
B2-DLM-0616	14255-0616	20241850	3/8	16x1.5	17	0.93	23.6	1.98	50.2
B2-DLM-0618	14255-0618	20241838	3/8	18x1.5	19	0.96	24.4	2.01	51.1
B2-DLM-0622	14255-0622	20274103	3/8	22x1.5	22	1.00	25.4	2.05	52.1
B2-DLM-0822	14255-0822	20241846	1/2	22x1.5	22	1.02	26.0	2.27	57.6
B2-DLM-1026	14255-1026	20241851	5/8	26x1.5	27	1.07	27.1	2.42	61.6
B2-DLM-1226	14255-1226	20959262	3/4	26x1.5	27	1.087	27.7	2.64	67.1
B2-DLM-1230	14255-1230	20241854	3/4	30x2.0	32	1.24	31.5	2.79	70.9
B2-DLM-1636	14255-1636	20241839	1	36x2.0	36	1.34	34.1	3.12	79.1



Download the **MyCrimp App** for more information.

Section 1 B2 Fittings



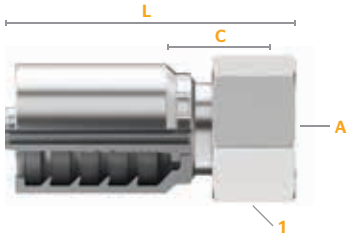

FITTINGS





DIN 24° Heavy

Female / Swivel

Part Number	Product Number	SAP Number							
			Hose ID	Thread Size (A)	Hex 1 Wrench Size	Cut-Off (C)		Length (L)	
			in.		mm	in.	mm	in.	mm
B2-DHFX-0416	14210-0416	20241801	1/4	16x1.5	19	1.20	30.5	2.18	55.4
B2-DHFX-0418	14210-0418	20241805	1/4	18x1.5	22	1.21	30.8	2.19	55.7
B2-DHFX-0518	14210-0518	20873159	5/16	18x1.5	22	1.262	32.0	2.242	56.9
B2-DHFX-0520	14210-0520	20873160	5/16	20x1.5	24	1.285	32.8	2.265	57.7
B2-DHFX-0618	14210-0618	20293217	3/8	18x1.5	22	1.23	31.3	2.28	57.9
B2-DHFX-0620	14210-0620	20241796	3/8	20x1.5	24	1.21	30.8	2.26	57.4
B2-DHFX-0622	14210-0622	20241803	3/8	22x1.5	27	1.42	36.2	2.47	62.8
B2-DHFX-0624	14210-0624	20790636	3/8	24x1.5	30	1.411	35.8	2.46	62.5
B2-DHFX-0820	14210-0820	20441214	1/2	20x1.5	24	1.24	31.4	2.48	63.0
B2-DHFX-0824	14210-0824	20241815	1/2	24x1.5	30	1.44	36.5	2.68	68.2
B2-DHFX-1030	14210-1030	20241807	5/8	30x2.0	36	1.64	41.7	2.99	76.0
B2-DHFX-1230 ^T	14210-1230	20241800	3/4	30x2.0	36	1.62	41.0	3.17	80.5
B2-DHFX-1236	14210-1236	20241799	3/4	36x2.0	46	1.89	47.9	3.44	87.4
B2-DHFX-1636	14210-1636	20864304	1	36x2.0	46	1.875	47.9	3.65	92.7
B2-DHFX-1642	14210-1642	20241830	1	42x2.0	50	1.88	47.9	3.66	92.9
B2-DHFX-2042	28210-2042	20241721	1 ¼	42x2.0	50	1.96	49.8	4.01	101.8
B2-DHFX-2052	28210-2052	20241818	1 ¼	52x2.0	60	2.20	55.8	4.24	107.7

^T=Thrust-Wire Nut (See Fitting Identification in Appendix for more information.)

FITTINGS



Section 1

B2 Fittings

COMPATIBLE HOSE:





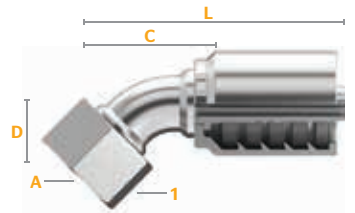

SR1SN	SR2SN	LR16SC	DR16SC	ACP3	SR12
DR1SN	DR2SN	SR16SC	XR16SC	XCP3	ARC12
SFS	LR2SN	ARC16SC	SCP3	XCP4	Hot Oilier

For a detailed list, please refer to your Crimp Specifications Manual.

DIN 24° Heavy

Female / 45° Elbow / Swivel



Part Number	Product Number	SAP Number									
			Hose ID	Thread Size (A)	Hex 1 Wrench Size	Drop (D)		Cut-Off (C)		Length (L)	
			in.		mm	in.	mm	in.	mm	in.	mm
B2-DHFX45-0416	14215-0416	20441303	1/4	16x1.5	19	0.63	16.0	1.93	49.0	2.91	73.9
B2-DHFX45-0418	14215-0418	20241817	1/4	18x1.5	22	0.75	19.1	1.69	42.9	2.67	67.8
B2-DHFX45-0518	14215-0518	20873161	5/16	18x1.5	22	0.75	19.1	1.695	43.2	2.675	68.1
B2-DHFX45-0520	14215-0520	20873162	5/16	20x1.5	24	0.79	20.1	2.008	51.1	2.988	75.9
B2-DHFX45-0620	14215-0620	20241821	3/8	20x1.5	24	0.79	20.1	2.01	51.1	3.06	77.7
B2-DHFX45-0622	14215-0622	20241822	3/8	22x1.5	27	0.83	21.1	2.09	53.1	3.14	79.7
B2-DHFX45-0624	14214-0624	20790638	3/8	24x1.5		0.85	21.6	2.174	55.2	3.223	81.9
B2-DHFX45-0824	14215-0824	20241819	1/2	24x1.5	30	0.85	21.6	2.20	55.9	3.45	87.6
B2-DHFX45-1030	14215-1030	20241823	5/8	30x2.0	36	1.18	30.0	2.60	66.0	3.96	100.5
B2-DHFX45-1236	14215-1236	20241820	3/4	36x2.0	46	1.30	33.0	2.72	69.1	4.27	108.5
B2-DHFX45-1642	14215-1642	20241828	1	42x2.0	50	1.59	40.4	4.33	110.0	6.11	155.1
B2-DHFX45-2052	14215-2052	20864303	1 1/4	52x2.0	60	1.551	39.4	3.826	97.3	5.872	149.1



Download the **MyCrimp App** for more information.

Section 1

B2 Fittings

FITTINGS



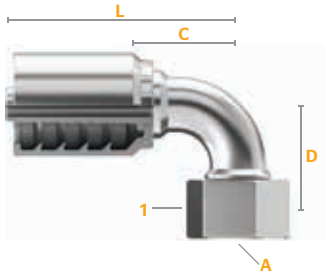

DIN 24° Heavy

Female / 90° Elbow / Swivel



Part Number	Product Number	SAP Number	Hose ID	Thread Size (A)	Hex 1 Wrench Size	Drop (D)		Cut-Off (C)		Length (L)	
			in.		mm	in.	mm	in.	mm	in.	mm
B2-DHFX90-0416	14220-0416	20477376	1/4	16x1.5	19	1.30	33.0	1.26	32.0	2.24	56.9
B2-DHFX90-0418	14220-0418	20241829	1/4	18x1.5	22	1.34	34.0	1.06	26.9	2.04	51.8
B2-DHFX90-0518	14220-0518	20873163	5/16	18x1.5	22	1.34	34.0	1.065	27.2	2.045	52.1
B2-DHFX90-0520	14220-0520	20873164	5/16	20x1.5	24	1.52	38.6	1.338	34.0	2.318	58.9
B2-DHFX90-0618	14220-0618	20441215	3/8	18x1.5	22	1.34	34.0	1.18	30.0	2.23	56.6
B2-DHFX90-0620	14220-0620	20241797	3/8	20x1.5	24	1.52	38.6	1.34	34.0	2.39	60.7
B2-DHFX90-0622	14220-0622	20241835	3/8	22x1.5	27	1.59	40.4	1.34	34.0	2.39	60.7
B2-DHFX90-0624	14220-0624	20790639	3/8	24x1.5	30	1.63	41.4	1.544	39.1	2.593	65.8
B2-DHFX90-0824	14220-0824	20241825	1/2	24x1.5	30	1.63	41.4	1.57	39.9	2.82	71.6
B2-DHFX90XL-0824	14224-0824	20790664	1/2	24x1.5	30	3.15	80.0	1.969	50.0	3.216	81.8
B2-DHFX90-1030	14220-1030	20241832	5/8	30x2.0	36	2.17	55.1	1.97	50.0	3.33	84.5
B2-DHFX90L-1030	14224-1030	20873227	5/8	30x2.0	36	3.15	80.0	1.968	50.0	3.325	84.5
B2-DHFX90-1230	14220-1230	20873165	3/4	30x2.0	46	2.28	57.9	2.01	51.1	3.563	90.5
B2-DHFX90-1236	14220-1236	20241836	3/4	36x2.0	46	2.34	59.4	2.01	51.1	3.56	90.5
B2-DHFX90-1636	14220-1636	20864305	1	36x2.0	50	2.48	63.0	2.56	66.0	4.335	110.2
B2-DHFX90-1642	14220-1642	20241824	1	42x2.0	50	3.11	79.0	2.99	75.9	4.77	121.0
B2-DHFX90-2052	28220-2052	20265706	1 1/4	52x2.0	60	3.62	91.9	3.70	94.0	5.75	145.9

FITTINGS



Section 1

B2 Fittings

COMPATIBLE HOSE:





SR1SN	SR2SN	LR16SC	DR16SC	ACP3	SR12
DR1SN	DR2SN	SR16SC	XR16SC	XCP3	ARC12
SFS	LR2SN	ARC16SC	SCP3	XCP4	Hot Oilier

For a detailed list, please refer to your Crimp Specifications Manual.

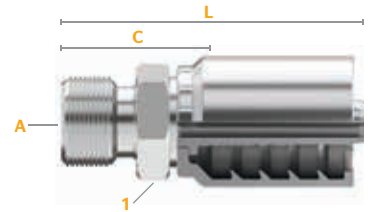
DIN 24° Heavy

Male







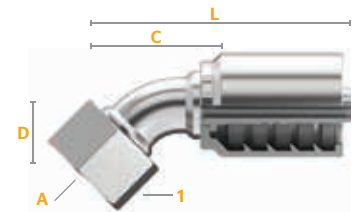

Part Number	Product Number	SAP Number							
			Hose ID	Thread Size (A)	Hex 1 Wrench Size	Cut-Off (C)	Length (L)	in.	mm
			in.		mm	in.	mm	in.	mm
B2-DHM-0416	14225-0416	20241810	1/4	16x1.5	17	0.95	24.2	1.93	49.1
B2-DHM-0418	14225-0418	20241811	1/4	18x1.5	19	0.99	25.2	1.97	50.1
B2-DHM-0620	14225-0620	20241813	3/8	20x1.5	22	1.00	25.4	2.05	52.1
B2-DHM-0622	14225-0622	20241804	3/8	22x1.5	22	1.08	27.4	2.13	54.1
B2-DHM-0824	14225-0824	20241809	1/2	24x1.5	24	1.14	29.0	2.39	60.7
B2-DHM-1030	14225-1030	20241814	5/8	30x2.0	32	1.31	33.1	2.66	67.6
B2-DHM-1230	14225-1230	20241812	3/4	30x2.0	32	1.33	33.7	2.88	73.1
B2-DHM-1236	14225-1236	20241816	3/4	36x2.0	36	1.48	37.7	3.04	77.1
B2-DHM-1642	14225-1642	20241808	1	42x2.0	46	1.66	42.1	3.43	87.2
B2-DHM-2052	14225-2052	20864302	1 1/4	52x2.0	55	1.875	47.8	3.921	99.6

DIN 60°

Female / 45° Elbow / Swivel



Part Number	Product Number	SAP Number									
			Hose ID	Thread Size (A)	Hex 1 Wrench Size	Drop (D)	Cut-Off (C)	Length (L)	in.	mm	
			in.		mm	in.	mm	in.	mm		
B2-DNFX45-0414	14275-0414	20241882	1/4	14x1.5	17	0.63	16.0	1.38	35.1	2.36	59.9
B2-DNFX45-0416	14275-0416	20241881	1/4	16x1.5	19	0.67	17.0	1.42	36.1	2.40	61.0
B2-DNFX45-0618	14275-0618	20241873	3/8	18x1.5	22	0.77	19.6	1.69	42.9	2.74	69.6
B2-DNFX45-0822	14275-0822	20241879	1/2	22x1.5	27	0.79	20.1	2.17	55.1	3.42	86.8
B2-DNFX45-1026	14275-1026	20241880	5/8	26x1.5	32	1.02	25.9	2.44	62.0	3.80	96.4



Download the **MyCrimp App**
for more information.

Section 1
B2 Fittings

FITTINGS



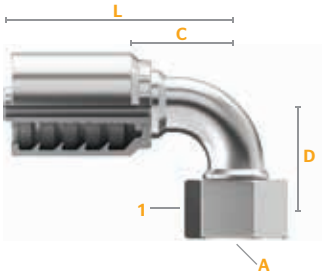

DIN 60°

Female / 90° Elbow / Swivel



Part Number	Product Number	SAP Number	Hose ID	Thread Size (A)	Hex 1 Wrench Size	Drop (D)		Cut-Off (C)		Length (L)	
			in.		mm	in.	mm	in.	mm	in.	mm
B2-DNFX90-0414	14280-0414	20241878	1/4	14x1.5	17	1.28	32.5	1.18	30.0	2.16	54.9
B2-DNFX90-0416	14280-0416	20241877	1/4	16x1.5	19	1.28	32.5	1.10	27.9	2.08	52.8
B2-DNFX90-0616	14280-0616	20241876	3/8	16x1.5	19	1.26	32.0	1.18	30.0	2.23	56.6
B2-DNFX90-0618	14280-0618	20241875	3/8	18x1.5	22	1.46	37.1	1.30	33.0	2.44	62.0
B2-DNFX90-0822	14280-0822	20241883	1/2	22x1.5	27	1.57	39.9	1.57	39.9	2.82	71.6
B2-DNFX90-1026	14280-1026	20241874	5/8	26x1.5	32	1.85	47.0	2.05	52.1	3.41	86.5

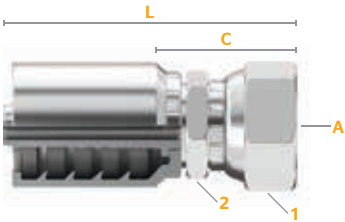

Komatsu® 30° Flare with Metric Threads

Female / Swivel



Part Number	Product Number	SAP Number	Hose ID	Thread Size (A)	Hex 1 Wrench Size	Hex 2 Wrench Size	Cut-Off (C)		Length (L)	
			in.		mm	mm	in.	mm	in.	mm
B2-KMFX-0414	14545-0414	20241888	1/4	14x1.5	19	17	1.22	30.9	2.20	55.8
B2-KMFX-0618	14545-0618	20241894	3/8	18x1.5	22	19	1.26	32.1	2.31	58.7
B2-KMFX-0822	14545-0822	20241891	1/2	22x1.5	27	22	1.38	35.2	2.63	66.8
B2-KMFX-1024	14545-1024	20241886	5/8	24x1.5	32	30	1.66	42.2	3.02	76.6
B2-KMFX-1230	14545-1230	20241884	3/4	30x1.5	36	30	1.84	46.7	3.39	86.1
B2-KMFX-1633	14545-1633	20241893	1	33x1.5	41	36	2.24	56.9	4.02	102.0
B2-KMFX-2036	28545-2036	20241889	1 ¼	36x1.5	46	46	2.50	63.6	4.55	115.5
B2-KMFX-2442	28545-2442	20241890	1 ½	42x1.5	55	55	2.63	66.9	4.96	126.0

FITTINGS



Section 1

B2 Fittings

COMPATIBLE HOSE:





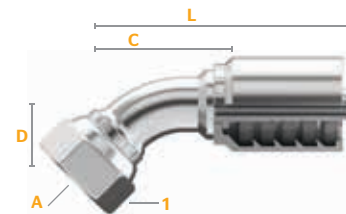

SR1SN	SR2SN	LR16SC	DR16SC	ACP3	SR12
DR1SN	DR2SN	SR16SC	XR16SC	XCP3	ARC12
SFS	LR2SN	ARC16SC	SCP3	XCP4	Hot Oilier

For a detailed list, please refer to your Crimp Specifications Manual.

Komatsu® 30° Flare with Metric Threads

Female / 45° Elbow / Swivel







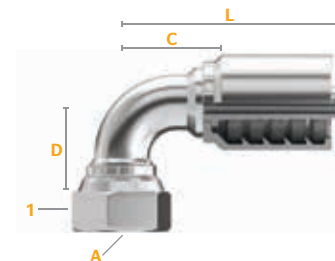

Part Number	Product Number	SAP Number									
			Hose ID	Thread Size (A)	Hex 1 Wrench Size	Drop (D)	in.	mm	in.	mm	
B2-KMFX45-0414	14548-0414	20293383	in.		mm	in.	mm	in.	mm	in.	mm
B2-KMFX45-0618	14548-0618	20293384	1/4	14x1.5	19	0.61	15.5	1.50	38.1	2.48	63.0
B2-KMFX45-0822	14548-0822	20293385	3/8	18x1.5	22	0.71	18.0	1.73	43.9	2.78	70.6
B2-KMFX45-0822	14548-0822	20293385	1/2	22x1.5		1.16	29.5	2.20	55.9	3.45	87.6
B2-KMFX45-1024	14548-1024	20293386	5/8	24x1.5	32	1.32	33.5	2.27	57.7	4.08	103.6
B2-KMFX45-1230	14548-1230	20293387	3/4	30x1.5	36	1.67	42.4	3.11	79.0	4.66	118.4
B2-KMFX45-1633	14548-1633	20293388	1	33x1.5	41	2.52	64.0	4.69	119.1	6.47	164.2

Komatsu® 30° Flare with Metric Threads

Female / 90° Elbow / Swivel



Part Number	Product Number	SAP Number									
			Hose ID	Thread Size (A)	Hex 1 Wrench Size	Drop (D)	in.	mm	in.	mm	
B2-KMFX90-0414	14550-0414	20293389	in.		mm	in.	mm	in.	mm	in.	mm
B2-KMFX90-0822	14550-0822	20293391	1/4	14x1.5	19	1.16	29.5	1.30	33.0	2.28	57.9
B2-KMFX90-0822	14550-0822	20293391	1/2	22x1.5	27	2.09	53.1	1.74	44.1	2.98	75.8
B2-KMFX90-1024	14550-1024	20293392	5/8	24x1.5	32	2.44	62.0	1.97	50.0	3.33	84.5
B2-KMFX90-1230	14550-1230	20293393	3/4	30x1.5	36	2.99	75.9	2.05	52.1	3.60	91.5
B2-KMFX90-1633	14550-1633	20293394	1	33x1.5	41	4.49	114.0	3.11	79.0	4.89	124.1



Download the **MyCrimp App** for more information.

Section 1

B2 Fittings





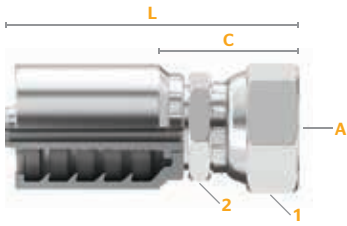

FITTINGS





JIS 30° (Parallel Pipe Threads)



Female / Swivel

Part Number	Product Number	SAP Number								
			Hose ID	Thread Size (A)	Hex 1 Wrench Size	Hex 2 Wrench Size	Cut-Off (C)	Length (L)	in.	mm
B2-JSFX-0404	14520-0404	20242055	1/4	1/4-19	19	17	1.22	30.9	2.20	55.8
B2-JSFX-0406	14520-0406	20833308	1/4	3/8-19	22	17	0.85	21.6	1.83	46.5
B2-JSFX-0606	14520-0606	20242058	3/8	3/8-19	22	19	1.26	32.1	2.31	58.7
B2-JSFX-0608	14520-0608	20833308	3/8	1/2-14	27	22	0.90	22.9	1.95	49.5
B2-JSFX-0808	14520-0808	20242057	1/2	1/2-14	27	22	1.39	35.2	2.63	66.9
B2-JSFX-1012	14520-1012	20293229	5/8	3/4-14	36	30	1.56	39.7	2.92	74.1
B2-JSFX-1212	14520-1212	20242054	3/4	3/4-14	36	30	1.58	40.2	3.14	79.6
B2-JSFX-1616	14520-1616	20242052	1	1-11	41	36	1.87	47.5	3.65	92.6
B2-JSFX-2020 ^T	28520-2020	20241722	1 1/4	1 1/4-11	50	46	2.16	54.9	4.21	106.9

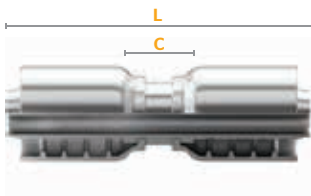
^T=Thrust-Wire Nut (See Fitting Identification in Appendix for more information.)



Hose Joiner

Part Number	Product Number	SAP Number						
			Hose ID	in.	mm	in.	mm	
B2-HJ-0404	14840-0404	20960641	1/4	0.71	18.0	1.69	42.9	
B2-HJ-0505	14840-0505	20960642	5/16	0.87	22.1	1.92	48.8	
B2-HJ-0606	14840-0606	20960643	3/8	1.10	27.9	2.41	61.2	
B2-HJ-0808	14840-0808	20960644	1/2	0.63	15.9	2.59	65.7	
B2-HJ-1010	14840-1010	20960645	5/8	0.63	15.9	2.59	65.7	
B2-HJ-1212	14840-1212	20960646	3/4	0.63	15.9	2.72	69.2	
B2-HJ-1616	14840-1616	20960647	1	0.75	19.1	3.24	82.4	
B2-HJ-2020	28840-2020	20960648	1 1/4	0.75	19.1	3.46	88.0	
B2-HJ-2424	28840-2424	20960649	1 1/2	0.75	19.1	3.86	98.0	
B2-HJ-3232	28840-3232	20960650	2	1.00	25.4	4.55	115.6	

FITTINGS



Section 1

B2 Fittings

COMPATIBLE HOSE:

SR1SN	SR2SN	LR16SC	DR16SC	ACP3	SR12
DR1SN	DR2SN	SR16SC	XR16SC	XCP3	ARC12
SFS	LR2SN	ARC16SC	SCP3	XCP4	Hot Oilier

For a detailed list, please refer to your Crimp Specifications Manual.

SECTION 2 - SG FITTINGS

This section lists all fittings compatible with the following hose:

Hose	Description	Compatible Dash Size	Hose	Description	Compatible Dash Size
SR12	SAE 110R12 / EN 856 R12	Hose dash sizes below -24	S4SP	EN 856 4SP / DIN 20023 4SP	All hose dash sizes
ARC12	SAE 100R12 / EN 856 R12	Hose dash sizes below -24	S4SH	EN 856 4SH / DIN 20023 4SH	All hose dash sizes
SR13	SAE 100R13 / EN 856 R13	Hose dash sizes below -24	XCP3S	SAE 100R12	All hose dash sizes
ARC13	SAE 100R13	Hose dash sizes below -24	XCP4S	SAE 100R12	All hose dash sizes
SR15	SAE 100R15	Hose dash sizes below -24	XCP5S	SAE 100R13	Hose dash sizes below -24
ARC15	SAE 100R15	Hose dash sizes below -20	XCP6S	SAE 100R15	Hose dash sizes below -24

How to Use the Fittings Table

The fittings in this section will follow a similar table structure to the one seen on this page.

Fitting dimensions and attributes are explained below.

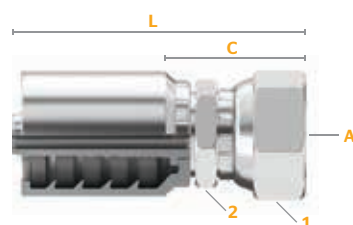

Fitting Name

Fitting Description

Part Number	Product Number	SAP Number										
			Hose ID	Thread Size (A)	Hex 1 Wrench Size	Hex 2 Wrench Size	Cut-Off (C)	Length (L)				
SG-JCFX-0606	29400-0606	20758248	in.	9/16-18	3/4	19	11/16	17	1.32	33.6	2.78	70.6
SG-JCFX-0808	29400-0808	20753008	1/2	3/4-16	1	25	3/4	19	1.09	27.7	2.63	66.7
SG-JCFX-1010	29400-1010	20822050	5/8	7/8-14	1 1/16	27	15/16	24	1.76	44.8	3.36	85.3

Fitting Dimensions and Attributes

Part Number See Hydraulic Fittings Nomenclature on page 128 for a breakdown of part number attributes

Hose ID The compatible Hose ID

Tube ID The compatible Tube ID

Thread Size The thread size or sizes available for a particular fitting dash size (indicated by **A** in the fitting image)

Hex Size The wrench size for one or both nuts on the fitting (indicated by **1** or **2** in the fitting image)

Drop The length of the elbow (indicated by **D** in the fitting image)

Cut-Off The amount of hose to be cut for a correct assembly length (indicated by **C** in the fitting image)

Length The overall length of the fitting

Skive Type For applicable fittings, a skive type will be indicated as Skive, Non-Skive or Dual-Grip

Choose fittings carefully, considering the working pressure of both the hose and fitting. The maximum working pressure of the hose assembly is the lesser of the rated working pressure of the hose and the fitting. See page 389 for the Fittings Working Pressure Guide.



Download the **MyCrimp App** for more information.

Section 2
SG Fittings

FITTINGS



SG Fittings Overview

A complete overview of all SG fittings found in this section.

<p>JIC 37° Flare (SAE J514) Female Swivel  SG-JCFX P. 183</p>	<p>JIC 37° Flare (SAE J514) Female 45° Elbow Swivel  SG-JCFX45 P. 184</p>	<p>JIC 37° Flare (SAE J514) Female 90° Elbow Swivel  SG-JCFX90 P. 184</p>	<p>JIC 37° Flare (SAE J514) Female 90° Block Elbow Swivel  SG-JCFX90B P. 186</p>
<p>JIC 37° Flare (SAE J514) Male  SG-JCM P. 186</p>	<p>NPTF Female  SG-NPF P. 187</p>	<p>NPTF Male  SG-NPFX P. 187</p>	<p>NPT API Male  SG-NPTAPI P. 188</p>
<p>NPTF Male Swivel  SG-NPMX P. 188</p>	<p>NPSM Female Swivel  SG-NSFX P. 188</p>	<p>Standpipe  SG-SP P. 189</p>	<p>O-Ring Face Seal (SAE J1453 ORS/ORFS) Female Swivel  SG-OFFX P. 189</p>
<p>O-Ring Face Seal (SAE J1453 ORS/ORFS) Female 45° Elbow Swivel  SG-OFFX45 P. 190</p>	<p>O-Ring Face Seal (SAE J1453 ORS/ORFS) Female 90° Elbow Swivel  SG-OFFX90 P. 190</p>	<p>O-Ring Face Seal (SAE J1453 ORS/ORFS) Male  SG-OFM P. 192</p>	<p>O-Ring Boss Straight Thread (SAE J514) Male  SG-OBM P. 192</p>
<p>Code 61 Flange (SAE J518)  SG-FL P. 193</p>	<p>Code 61 Flange (SAE J518) 22.5° Elbow  SG-FL22 P. 193</p>	<p>Code 61 Flange (SAE J518) 30° Elbow  SG-FL30 P. 194</p>	<p>Code 61 Flange (SAE J518) 45° Elbow  SG-FL45 P. 194</p>
<p>Code 61 Flange (SAE J518) 60° Elbow  SG-FL60 P. 195</p>	<p>Code 61 Flange (SAE J518) 67° Elbow  SG-FL67 P. 196</p>	<p>Code 61 Flange (SAE J518) 90° Elbow  SG-FL90 P. 196</p>	<p>Code 61 Flange (SAE J518) 110° Elbow  SG-FL110 P. 197</p>
<p>Code 61 Flange (SAE J518) 135° Elbow  SG-FL135 P. 198</p>	<p>Code 62 Flange (SAE J518)  SG-FH P. 198</p>	<p>Code 62 Flange (SAE J518) 22.5° Elbow  SG-FH22 P. 199</p>	<p>Code 62 Flange (SAE J518) 30° Elbow  SG-FH30 P. 199</p>

SG Fittings Overview

A complete overview of all SG fittings found in this section.

Code 62 Flange (SAE J518)

45° Elbow



SG-FH45

P. 200

Code 62 Flange (SAE J518)

60° Elbow



SG-FH60

P. 200

Code 62 Flange (SAE J518)

67° Elbow



SG-FH67

P. 201

Code 62 Flange (SAE J518)

90° Elbow



SG-FH90

P. 201

Caterpillar® Flange



SG-CF

P. 202

Caterpillar® Flange

22.5° Elbow



SG-CF22

P. 202

Caterpillar® Flange

30° Elbow



SG-CF30

P. 203

Caterpillar® Flange

45° Elbow



SG-CF45

P. 203

Caterpillar® Flange

60° Elbow



SG-CF60

P. 204

Caterpillar® Flange

67° Elbow



SG-CF67

P. 204

Caterpillar® Flange

90° Elbow



SG-CF90

P. 205

IHUF Hammer Union



SG-IHUF

P. 205

IHUM Hammer Union



SG-IHUM

P. 205

Komatsu® Flange



SG-KF

P. 206

Komatsu® Flange

45° Elbow



SG-KF45

P. 206

Komatsu® Flange

90° Elbow



SG-KF90

P. 206

BSPP (British Standard Pipe Parallel)

Female Swivel



SG-BPFX

P. 207

BSPP (British Standard Pipe Parallel)

Female 45° Elbow Swivel



SG-BPFX45

P. 207

BSPP (British Standard Pipe Parallel)

Female 90° Elbow Swivel



SG-BPFX90

P. 208

BSPP (British Standard Pipe Parallel)

Male



SG-BPM

P. 208

BSPT (British Standard Pipe Tapered)

Male



SG-BTM

P. 209

BSP Flat Seat (British Standard Pipe)

Female Swivel



SG-BFFX

P. 209

DIN 24° Light

Female Swivel



SG-DLFX

P. 209

DIN 24° Light

Female 45° Elbow Swivel



SG-DLFX45

P. 210

DIN 24° Light

Female 90° Elbow Swivel



SG-DLFX90

P. 210

DIN 24° Light

Male



SG-DLM

P. 211

DIN 24° Heavy

Female Swivel



SG-DHFX

P. 211

DIN 24° Heavy

Female 45° Elbow Swivel



SG-DHFX45

P. 212



Download the **MyCrimp App** for more information.







Section 2
SG Fittings

FITTINGS



SG Fittings Overview





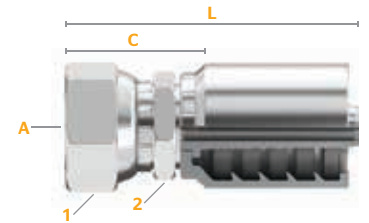

A complete overview of all SG fittings found in this section.

<p>DIN 24° Heavy</p> <p>Female 90° Elbow Swivel</p>  <p>SG-DHFX90 P. 213</p>	<p>DIN 24° Heavy</p> <p>Male</p>  <p>SG-DHM P. 213</p>	<p>Komatsu® 30° Flare with Metric Threads</p> <p>Female Swivel</p>  <p>SG-KMFX P. 214</p>	<p>Komatsu® 30° Flare with Metric Threads</p> <p>Female 45° Elbow Swivel</p>  <p>SG-KMFX45 P. 214</p>
<p>Komatsu® 30° Flare with Metric Threads</p> <p>Female 90° Elbow Swivel</p>  <p>SG-KMFX90 P. 215</p>	<p>JIS 30° (Parallel Pipe Threads)</p> <p>Female Swivel</p>  <p>SG-JSFX P. 215</p>		

JIC 37° Flare (SAE J514)

Female / Swivel



Part Number	Product Number	SAP Number										
			Hose ID	Thread Size (A)	Hex 1 Wrench Size	Hex 2 Wrench Size	Cut-Off (C)	Length (L)				
			in.		in.	mm	in.	mm	in.	mm	in.	mm
SG-JCFX-0604	29400-0604	20822056	3/8	7/16-20	5/8	16	11/16	17	1.27	32.2	2.73	69.2
SG-JCFX-0606	29400-0606	20758248	3/8	9/16-18	3/4	19	11/16	17	1.32	33.6	2.78	70.6
SG-JCFX-0606S	29400-0606S	20822055	3/8	9/16-18	3/4	19	11/16	17	1.32	33.6	2.78	70.6
SG-JCFX-0608	29400-0608	20758284	3/8	3/4-16	1	25	3/4	19	1.09	27.7	2.55	64.7
SG-JCFX-0610	29400-0610	20822054	3/8	7/8-14	1 1/6	27	7/8	22	1.63	41.4	3.09	78.5
SG-JCFX-0806	29400-0806	20822053	1/2	9/16-18	3/4	19	3/4	19	1.36	34.6	2.90	73.6
SG-JCFX-0808	29400-0808	20753008	1/2	3/4-16	1	25	3/4	19	1.09	27.7	2.63	66.7
SG-JCFX-0808S	29400-0808S	20822052	1/2	3/4-16	1	25	3/4	19	1.09	27.7	2.63	66.7
SG-JCFX-0810	29400-0810	20758294	1/2	7/8-14	1 1/6	27	7/8	22	1.64	41.6	3.17	80.6
SG-JCFX-0812 ^T	29400-0812	20758299	1/2	1 1/6-12	1 1/4	32	1	25	1.74	44.2	3.28	83.2
SG-JCFX-1008	29400-1008	20822051	5/8	3/4-16	1	25	15/16	24	1.65	41.9	3.24	82.3
SG-JCFX-1010	29400-1010	20822050	5/8	7/8-14	1 1/6	27	15/16	24	1.76	44.8	3.36	85.3
SG-JCFX-1010S	29400-1010S	20822049	5/8	7/8-14	1 1/6	27	15/16	24	1.76	44.8	3.36	85.3
SG-JCFX-1012T	29400-1012	20822048	5/8	1 1/6-12	1 1/4	32	1	25	1.76	44.7	3.35	85.2
SG-JCFX-1210	29400-1210	20822047	3/4	7/8-14	1 1/6	27	1 1/6	27	1.74	44.2	3.61	91.7
SG-JCFX-1212 ^T	29400-1212	20822046	3/4	1 1/6-12	1 1/4	32	1 1/6	27	1.80	45.7	3.67	93.2
SG-JCFX-1212S ^T	29400-1212S	20822045	3/4	1 1/6-12	1 1/4	32	1 1/6	27	1.80	45.7	3.67	93.2
SG-JCFX-1214	29400-1214	20822044	3/4	1 3/8-12	1 1/6	36	1 1/4	32	1.87	47.5	3.74	95.0
SG-JCFX-1216 ^T	29400-1216	20822043	3/4	1 5/8-12	1 1/2	38	1 1/4	32	1.46	37.1	3.33	84.6
SG-JCFX-1612 ^T	29400-1612	20822042	1	1 1/6-12	1 1/4	32	1 1/4	32	1.42	36.1	3.71	94.1
SG-JCFX-1616 ^T	29400-1616	20822041	1	1 5/8-12	1 1/2	38	1 1/4	32	2.12	53.7	4.40	111.7
SG-JCFX-1616S ^T	29400-1616S	20822040	1	1 5/8-12	1 1/2	38	1 1/4	32	2.12	53.7	4.40	111.7
SG-JCFX-1620 ^T	29400-1620	20822039	1	1 7/8-12	2	50	1 3/8	41	1.62	41.1	3.90	99.1
SG-JCFX-2020	29400-2020	20926505	1 1/4	1 5/8-12	2	50	1 3/8	41	2.383	60.5	5.517	140.2
SG-JCFX-2020S	29400-2020S	20926531	1 1/4	1 5/8-12	2	50	1 3/8	41	2.383	60.5	5.517	140.2
SG-JCFX-2024	29400-2024	20926506	1 1/4	1 7/8-12	2 3/6	55	2	50	2.663	67.6	5.797	147.3
SG-JCFX-2424	29400-2424	20757741	1 1/2	1 3/8-12	2 3/6	55			2.88	73.1	6.34	161.1
SG-JCFX-2424S	29400-2424S	20873141	1 1/2	1 3/8-12	2 3/6	55			2.88	73.1	6.34	161.1
SG-JCFX-3232	29400-3232	20833298	2	2 1/2-12	2 3/6	70			3.41	86.5	6.95	176.5
SG-JCFX-3232S	29400-3232S	20873142	2	2 1/2-12	2 3/6	70			3.406	86.5	6.95	176.5

T=Thrust-Wire Nut S=Stainless Steel (See Fitting Identification in Appendix for more information.)



Download the **MyCrimp App** for more information.

Section 2
SG Fittings

FITTINGS



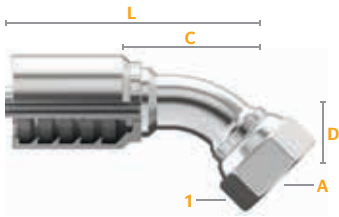

JIC 37° Flare (SAE J514)

Female / 45° Elbow / Swivel

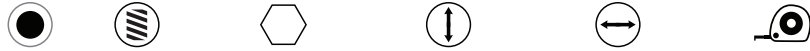

Part Number	Product Number	SAP Number	Thread Size (A)		Hex 1 Wrench Size		Drop (D)		Cut-Off (C)		Length (L)	
			Hose ID	in.	in.	mm	in.	mm	in.	mm	in.	mm
SG-JCFX45-0606	29240-0606	20758293	3/8	9/16-18	3/4	19	0.43	11.0	1.81	46.0	3.27	83.0
SG-JCFX45-0608	29240-0608	20822038	3/8	3/4-16	1	25	0.59	15.0	1.85	47.0	3.31	84.0
SG-JCFX45-0808	29240-0808	20758293	1/2	3/4-16	1	25	0.59	15.0	2.08	52.9	3.62	91.9
SG-JCFX45-0810	29240-0810	20822037	1/2	7/8-14	1 1/16	27	0.63	16.0	2.01	51.0	3.54	90.0
SG-JCFX45-1010	29240-1010	20822036	5/8	7/8-14	1 1/16	27	0.63	16.0	1.76	44.8	4.15	105.5
SG-JCFX45-1012 ^T	29240-1012	20822035	5/8	7/8-14	1 1/4	32	0.90	22.9	2.56	65.0	4.15	105.5
SG-JCFX45-1212 ^T	29420-1212	20822034	3/4	1 1/16-12	1 1/4	32	1.08	27.4	2.79	70.8	4.91	124.8
SG-JCFX45-1216	29420-1216	20822033	3/4	1 1/16-12	1 1/2	38	1.02	26.0	2.80	71.0	4.67	118.5
SG-JCFX45-1616 ^T	29420-1616	20822032	1	1 1/16-12	1 1/2	38	1.19	30.1	3.30	83.7	5.58	141.7
SG-JCFX45-1616S ^T	29420-1616S	20822031	1	1 1/16-12	1 1/2	38	1.19	30.1	3.30	83.7	5.58	141.7
SG-JCFX45-1620 ^T	29420-1620	20822030	1	1 1/8-12	2	50	1.25	31.8	3.37	85.6	5.65	143.6
SG-JCFX45-2020	29420-2020	20926507	1 1/4	1 1/8-12	2	50	1.46	37.1	4.09	104.0	7.23	183.6
SG-JCFX45-2424	29420-2424	20757727	1 1/2	1 3/8-12	2 3/16	55	1.56	39.7	4.65	118.1	8.12	206.1

T=Thrust-Wire Nut S=Stainless Steel (See Fitting Identification in Appendix for more information.)

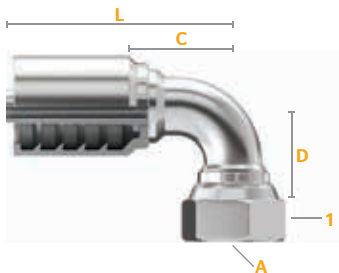

JIC 37° Flare (SAE J514)

Female / 90° Elbow / Swivel



Part Number	Product Number	SAP Number	Thread Size (A)		Hex 1 Wrench Size		Elbow Type ^e	Drop (D)		Cut-Off (C)		Length (L)	
			Hose ID	in.	in.	mm		in.	mm	in.	mm	in.	mm
SG-JCFX90-0604	29425-0604	20822029	3/8	7/16-29	5/8	16		1.26	32.0	1.38	35.0	2.84	72.0
SG-JCFX90L-0604	29440-0604	20822018	3/8	7/16-29	5/8	16	LT	1.81	46.0	1.22	31.0	2.68	68.0
SG-JCFX90-0606	29425-0606	20758283	3/8	9/16-18	3/4	19		1.50	38.0	1.22	31.0	2.67	67.7
SG-JCFX90L-0606	29440-0606	20822017	3/8	9/16-18	3/4	19	LT	2.13	54.0	1.69	43.0	3.15	80.0
SG-JCFX90S-0606	29445-0606	20822008	3/8	9/16-18	3/4	19	ST	0.91	23.0	1.65	42.0	3.11	79.0
SG-JCFX90-0608	29425-0608	20822028	3/8	3/4-16	1	25		1.61	41.0	1.54	39.0	2.99	76.0
SG-JCFX90L-0608	29440-0608	20822016	3/8	3/4-16	1	25	LT	2.52	64.0	1.85	47.0	3.31	84.0
SG-JCFX90S-0608	29445-0608	20822007	3/8	3/4-16	1	25	ST	1.85	47.0	1.93	49.0	3.39	86.0

Continued on the next page.

FITTINGS



Section 2

SG Fittings

COMPATIBLE HOSE:

SR12 SR13 SR15 S4SP XCP3S XCP5S
 ARC12 ARC13 ARC15 S4SH XCP4S XCP6S

For a detailed list, please refer to your Crimp Specifications Manual.

JIC 37° Flare (Female 90° Elbow) Continued

Part Number	Product Number	SAP Number	Hose ID	Thread Size (A)	Hex 1 Wrench Size		Elbow Type*	Drop (D)		Cut-Off (C)		Length (L)	
			in.		in.	mm		in.	mm	in.	mm	in.	mm
SG-JCFX90-0808	29425-0808	20758292	1/2	3/4-16	1	25		1.58	40.0	1.49	37.9	3.03	76.9
SG-JCFX90L-0808	29440-0808	20822015	1/2	3/4-16	1	25	LT	2.52	64.0	2.01	50.9	3.54	89.9
SG-JCFX90S-0808	29445-0808	20822006	1/2	3/4-16	1	25	ST	1.14	29.0	1.81	46.0	3.38	85.9
SG-JCFX90-0810	29425-0810	20822027	1/2	7/8-14	1 1/16	27		1.85	47.0	1.69	43.0	3.23	82.0
SG-JCFX90L-0810	29440-0810	20822014	1/2	7/8-14	1 1/16	27	LT	2.76	70.0	1.46	37.0	2.99	76.0
SG-JCFX90S-0810	29445-0810	20822005	1/2	7/8-14	1 1/16	27	ST	1.26	32.0	1.81	46.0	3.38	85.9
SG-JCFX90-0812	29445-0812	20822026	1/2	1 1/16-12	1 1/4	32		1.81	46.0	1.49	37.9	3.03	76.9
SG-JCFX90-1010	29425-1010	20822025	5/8	7/8-14	1 1/16	27		1.85	47.0	1.76	44.8	3.52	89.5
SG-JCFX90L-1010	29440-1010	20822013	5/8	7/8-14	1 1/16	27	LT	2.76	70.0	1.76	44.8	3.56	90.5
SG-JCFX90S-1010	29445-1010	20822004	5/8	7/8-14	1 1/16	27	ST	1.26	32.0	1.76	44.8	3.52	89.5
SG-JCFX90-1012 ^T	29425-1012	20822024	5/8	1 1/16-12	1 1/4	32		2.28	58.0	2.35	59.7	3.94	100.2
SG-JCFX90L-1012 ^T	29440-1012	20822012	5/8	1 1/16-12	1 1/4	32	LT	3.78	96.0	2.35	59.7	3.94	100.2
SG-JCFX90-1210	29425-1210	20822023	3/4	7/8-14	1 1/16	27		1.85	47.0	1.97	50.0	3.84	97.5
SG-JCFX90L-1210	29440-1210	20822011	3/4	7/8-14	1 1/16	27	LT	2.76	70.0	1.97	50.0	3.84	97.5
SG-JCFX90S-1210	29445-1210	20822003	3/4	7/8-14	1 1/16	27	ST	1.26	32.0	1.97	50.0	3.84	97.5
SG-JCFX90-1212 ^T	29425-1212	20822022	3/4	1 1/16-12	1 1/4	32		2.24	56.9	2.35	59.7	4.22	107.2
SG-JCFX90L-1212 ^T	29440-1212	20822010	3/4	1 1/16-12	1 1/4	32	LT	3.78	96.0	2.35	59.7	4.22	107.2
SG-JCFX90S-1212 ^T	29445-1212	20822002	3/4	1 1/16-12	1 1/4	32	ST	1.89	48.0	2.35	59.7	4.22	107.2
SG-JCFX90-1216 ^T	29425-1216	20822021	3/4	1 5/16-12	1 1/2	38		2.80	71.0	2.35	59.7	4.22	107.2
SG-JCFX90-1616 ^T	29425-1616	20822020	1	1 5/16-12	1 1/2	38		2.80	71.0	2.97	75.5	5.25	133.5
SG-JCFX90L-1616 ^T	29440-1616	20822009	1	1 5/16-12	1 1/2	38	LT	4.49	114.0	3.10	78.7	5.38	136.7
SG-JCFX90S-1616 ^T	29445-1616	20822001	1	1 5/16-12	1 1/2	38	ST	2.44	61.9	2.55	64.8	4.83	122.8
SG-JCFX90-1620 ^T	29425-1620	20822019	1	1 3/8-12	2	50		3.07	78.0	2.87	72.9	5.15	130.9
SG-JCFX90-2020	29425-2020	20926508	1 1/4	1 5/8-12	2	50		3.07	78.0	3.622	92.0	6.76	171.6
SG-JCFX90-2020S	29425-2020S	20926532	1 1/4	1 5/8-12	2	50		3.07	78.0	3.622	92.0	6.76	171.6
SG-JCFX90-2024	29425-2024	20926509	1 1/4	1 7/8-12	2 3/16	55		3.39	86.0	3.94	100.0	7.07	179.6
SG-JCFX90L-2024	29440-2024	20926510	1 1/4	1 7/8-12	2 3/16	55	LT	5.55	141.0	3.94	100.0	7.07	179.6
SG-JCFX90-2424	29425-2424	20757723	1 1/2	1 7/8-12	2 3/16	55		3.45	87.6	4.53	115.0	7.99	203.0
SG-JCFX90-2424S	29425-2424S	20933836	1 1/2	1 7/8-12	2 3/16	55		3.45	87.6	4.53	115.0	7.99	203.0
SG-JCFX90-3232S	29425-3232S	20933837	2	2 1/2-12	2 3/4	70		5.51	140	5.08	129	9.25	235

T=Thrust-Wire Nut (See Fitting Identification in Appendix for more information.) *Elbow Type: LT=Long Tube ST=Short Tube



Download the **MyCrimp App** for more information.

Section 2

SG Fittings

FITTINGS



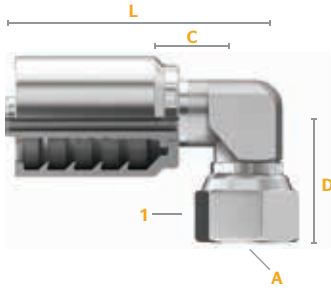

JIC 37° Flare (SAE J514)

Female / 90° Block Elbow / Swivel



Part Number	Product Number	SAP Number	Hose ID		Hex 1 Wrench Size		Elbow Type*	Drop (D)		Cut-Off (C)		Length (L)	
			in.	mm	in.	mm		in.	mm	in.	mm	in.	mm
SG-JCFX90B-0606		20840883	3/8	9/16-18	3/4	19	BE	1.13	28.7	0.93	23.7	2.39	60.7
SG-JCFX90B-0808		20840884	1/2	3/4-16	1	25	BE	1.66	42.3	1.00	25.5	2.54	64.5

*Elbow Type: BE=Block Elbow

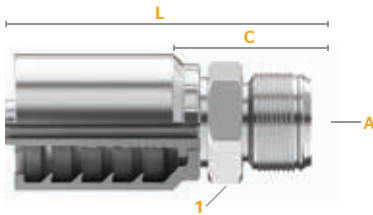

JIC 37° Flare (SAE J514)

Male



Part Number	Product Number	SAP Number	Hose ID		Hex 1 Wrench Size		Cut-Off (C)		Length (L)	
			in.	mm	in.	mm	in.	mm	in.	mm
SG-JCM-0606	29450-0606	20758249	3/8	9/16-18	11/16	17	1.15	29.1	2.60	66.1
SG-JCM-0608	29450-0608	20758285	3/8	3/4-16	3/4	19	1.29	32.8	2.75	69.9
SG-JCM-0610	29450-0610	20822000	3/8	7/8-14	15/16	24	1.45	36.8	2.91	73.8
SG-JCM-0808	29450-0808	20758291	1/2	3/4-16	3/4	19	1.29	32.8	2.83	71.9
SG-JCM-0810	29450-0810	20758296	1/2	7/8-14	15/16	24	1.45	36.8	2.99	75.8
SG-JCM-0812	29450-0812	20758295	1/2	1 1/8-12	1 1/8	27	1.54	39.1	3.07	78.1
SG-JCM-1010	29450-1010	20821999	5/8	7/8-14	15/16	24	1.47	37.3	3.06	77.8
SG-JCM-1012	29450-1012	20821998	5/8	7/8-14	1 1/8	27	1.56	39.6	3.15	80.1
SG-JCM-1212	29450-1212	20821997	3/4	1 1/8-12	1 1/8	27	1.60	40.6	3.47	88.1
SG-JCM-1214	29450-1229	20821996	3/4	1 3/8-12	1 1/4	32	1.73	43.9	3.60	91.4
SG-JCM-1216	29450-1216	20821995	3/4	1 1/2-12	1 1/2	36	1.77	45.1	3.66	93.1
SG-JCM-1616	29450-1616	20821994	1	1 1/2-12	1 1/2	36	1.83	46.6	4.12	104.6
SG-JCM-1620	29450-1620	20821993	1	1 3/8-12	1 3/8	46	1.99	50.5	4.27	108.6
SG-JCM-2020	29450-2020	20926511	1 1/4	1 3/8-12	1 3/8	46	2.14	54.5	5.278	134.1
SG-JCM-2020S	29450-2020S	20933838	1 1/4	1 3/8-12	1 3/8	46	2.14	54.5	5.28	134.1
SG-JCM-2024	29450-2024	20926512	1 1/4	1 1/2-12	1 3/8	46	2.33	59.2	5.46	138.8
SG-JCM-2424	29450-2424	20757728	1 1/2	1 3/8-12	2	50	2.54	64.6	6.01	152.6
SG-JCM-2424S	29450-2424S	20933839	1 1/2	1 3/8-12	2	50	2.54	64.6	6.01	152.6
SG-JCM-3232	29450-3232	20833302	2	2-12	2 1/8	70	2.97	75.5	6.52	165.6
SG-JCM-3232S	29450-3232S	20933840	2	2 1/2-12	2 1/8	70	2.97	75.5	6.518	165.6

FITTINGS



Section 2

SG Fittings

COMPATIBLE HOSE:

SR12 SR13 SR15 S4SP XCP3S XCP5S
 ARC12 ARC13 ARC15 S4SH XCP4S XCP6S

For a detailed list, please refer to your Crimp Specifications Manual.

NPTF

Female

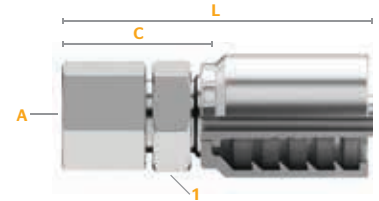

Part Number	Product Number	SAP Number	Hose ID	Thread Size (A)	Hex 1 Wrench Size		Cut-Off (C)		Length (L)	
			in.		in.	mm	in.	mm	in.	mm
SG-NPF-0808	29600-0808	20821973	1/2	1/2-14	1	25	1.48	37.6	3.02	76.6

NPTF

Male

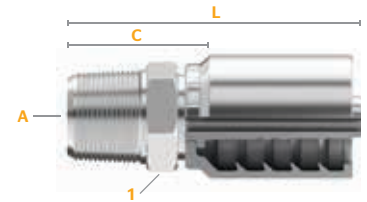

Part Number	Product Number	SAP Number	Hose ID	Thread Size (A)	Hex 1 Wrench Size		Cut-Off (C)		Length (L)	
			in.		in.	mm	in.	mm	in.	mm
SG-NPM-0604	29615-1608	20731608	3/8	1/4-18	1 1/16	17	1.17	29.7	2.63	66.8
SG-NPM-0606	29615-0606	20731748	3/8	3/8-18	3/4	19	1.20	30.5	2.66	67.5
SG-NPM-0606S	29615-0606S	20821971	3/8	3/8-18	3/4	19	1.20	30.5	2.66	67.5
SG-NPM-0608	29615-0608	20758280	3/8	1/2-14	7/8	22	1.37	34.9	2.83	71.9
SG-NPM-0806	29615-0806	20731755	1/2	3/8-18	3/4	19	1.20	30.5	2.73	69.4
SG-NPM-0808	29615-0808	20753007	1/2	1/2-14	7/8	22	1.37	34.9	2.91	73.9
SG-NPM-0808S	29615-0808S	20821970	1/2	1/2-14	7/8	22	1.37	34.9	2.91	73.9
SG-NPM-0812	29615-0812	20758303	1/2	3/4-14	1 1/16	27	1.42	36.0	2.95	75.0
SG-NPM-1012	29615-1012	20821969	5/8	3/4-14	1 1/16	27	1.44	36.5	3.03	77.0
SG-NPM-1208	29615-1208	20821968	3/4	1/2-14	1 1/16	27	1.43	36.4	3.30	83.9
SG-NPM-1212	29615-1212	20821967	3/4	3/4-14	1 1/16	27	1.48	37.5	3.35	85.0
SG-NPM-1212S	29615-1212S	20821966	3/4	3/4-14	1 1/16	27	1.48	37.5	3.35	85.0
SG-NPM-1216	29615-1216	20821965	3/4	1-11 1/2	1 1/16	36	1.83	46.6	3.70	94.1
SG-NPM-1612	29615-1612	20821964	1	3/4-14	1 1/16	36	1.70	43.2	3.99	101.2
SG-NPM-1616	29615-1616	20821963	1	1-11 1/2	1 1/16	36	1.89	48.1	4.18	106.1
SG-NPM-1616S	29615-1616S	20821962	1	1-11 1/2	1 1/16	36	1.89	48.1	4.18	106.1
SG-NPM-1620	29615-1620	20821961	1	1 1/4-11 1/2	1 3/16	46	2.03	51.5	4.31	109.5
SG-NPM-2020	29615-2020	20926515	1 1/4	1 1/4-11 1/2	1 3/16	46	2.18	55.4	5.312	135.0
SG-NPM-2020S	29615-2020S	20926533	1 1/4	1 1/4-11 1/2	1 3/16	46	2.18	55.4	5.312	135.0
SG-NPM-2024	29615-2024	20926516	1 1/4	1 1/2-11 1/2	2	50	2.24	56.9	5.38	136.5
SG-NPM-2424	29615-2424	20757742	1 1/2	1 1/2-11 1/2	2	50	2.46	62.4	5.92	150.4
SG-NPM-2424S	29615-2424S	20873143	1 1/2	1 1/2-11 1/2	2	50	2.46	62.4	5.92	150.4
SG-NPM-3232	29615-3232	20833301	2	2-11 1/2	2 3/16	70	2.67	67.9	6.22	157.9
SG-NPM-3232S	29615-3232S	20933841	2	2-11 1/2	2 3/16	70	2.67	67.9	6.22	157.9

S=Stainless Steel (See Fitting Identification in Appendix for more information.)



Download the **MyCrimp App** for more information.

Section 2
SG Fittings

FITTINGS



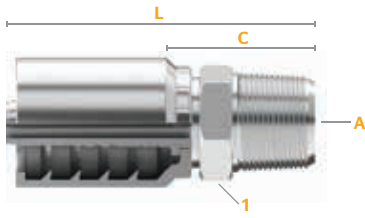

NPT API

Male



Part Number	Product Number	SAP Number	Hose ID		Thread Size (A)		Hex 1 Wrench Size		Cut-Off (C)		Length (L)	
			in.	mm	in.	mm	in.	mm	in.	mm	in.	mm
SG-NPM-API-1616	29617-1616	20821960	1		1-11 1/2 API API5B		1 7/16	36	2.72	69.0	5.00	127.0
SG-NPM-API-2424	29617-2424	20873223	1 1/4		1 1/2-11 1/2 API API15B		2	50	3.52	89.4	6.99	177.4
SG-NPM-API-3232	29617-2424	20833300	2		2-11 1/2 API API5B		2 13/16	70	4.35	110.5	7.90	200.5

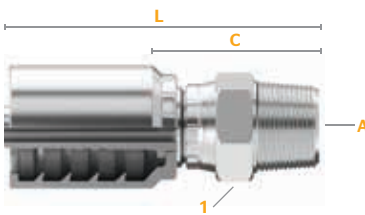

NPTF

Male / Swivel



Part Number	Product Number	SAP Number	Hose ID		Thread Size (A)		Hex 1 Wrench Size		Cut-Off (C)		Length (L)	
			in.	mm	in.	mm	in.	mm	in.	mm	in.	mm
SG-NPMX-0604	29645-0604	20821959	3/8		1/4-18		1 1/16	17	1.67	42.3	3.123	79.3
SG-NPMX-0606	29645-0606	20821958	3/8		3/8-18		7/8	22	1.58	40.1	3.04	77.1
SG-NPMX-0608	29645-0608	20821957	3/8		1/2-14		1	25	1.73	44.0	3.19	81.0
SG-NPMX-0806	29645-0806	20821956	1/2		3/8-18		7/8	22	1.58	40.1	3.12	79.1
SG-NPMX-0808	29645-0808	20821955	1/2		1/2-14		1	25	1.73	44.0	3.27	83.0
SG-NPMX-1212	29645-1212	20821954	3/4		3/4-14		1 1/4	32	2.08	52.8	3.95	100.3
SG-NPMX-1616	29645-1616	20821953	1		1-11 1/2		1 5/8	41	2.40	60.9	4.681	118.9

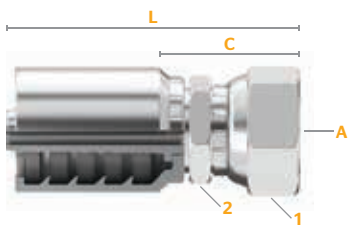

NPSM

Female / Swivel



Part Number	Product Number	SAP Number	Hose ID		Thread Size (A)		Hex 1 Wrench Size		Hex 2 Wrench Size		Cut-Off (C)		Length (L)	
			in.	mm	in.	mm	in.	mm	in.	mm	in.	mm	in.	mm
SG-NSFX-0606	29655-0606	20821948	3/8		3/8-18		7/8	22	11/16	17	1.29	32.8	2.75	69.8
SG-NSFX-0808	29655-0808	20821947	1/2		1/2-14		1 1/16	27	7/8	22	1.41	35.8	2.95	74.8
SG-NSFX-2020	29655-2020	20926517	1 1/4		1 1/4-11 1/2		2	50	1 3/8	41	2.27	57.6	5.40	137.2

FITTINGS



Section 2

SG Fittings

COMPATIBLE HOSE:

SR12 SR13 SR15 S4SP XCP3S XCP5S
 ARC12 ARC13 ARC15 S4SH XCP4S XCP6S

For a detailed list, please refer to your Crimp Specifications Manual.

Standpipe

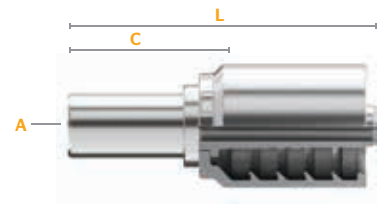

Part Number	Product Number	SAP Number	Hose ID	Tube O.D. (A)	Cut-Off (C)		Length (L)	
			in.	mm	in.	mm	in.	mm
SG-SP-1628	29825-1628	20821784	1	28	1.73	43.9	4.01	101.9

O-Ring Face Seal (SAE J1453 ORS/ORFS)

Female / Swivel

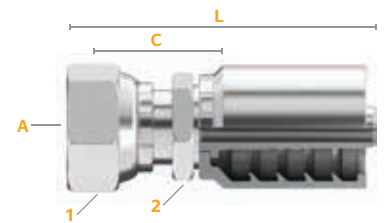

Part Number	Product Number	SAP Number	Hose ID	Thread Size (A)	Hex 1 Wrench Size	Hex 2 Wrench Size	Cut-Off (C)		Length (L)			
			in.		in.	mm	in.	mm	in.	mm		
SG-OFFX-0604	29700-0604	20821928	3/8	9/16-18	7/8	17	11/16	17	1.29	32.8	2.75	69.9
SG-OFFX-0606	29700-0606	20758282	3/8	11/16-16	7/8	22	11/16	18	1.29	32.8	2.75	69.9
SG-OFFX-0608	29700-0608	20731751	3/8	13/16-16	15/16	24	7/8	22	1.50	38.1	2.96	75.1
SG-OFFX-0806	29700-0806	20821927	1/2	11/16-16	7/8	22	3/4	19	1.34	34.0	2.87	73.0
SG-OFFX-0808	29700-0808	20731750	1/2	13/16-16	15/16	24	7/8	22	1.50	38.1	3.04	77.1
SG-OFFX-0810	29700-0810	20731764	1/2	1-14	1 3/16	30	15/16	24	1.63	41.5	3.17	80.5
SG-OFFX-0812	29700-0812	20731759	1/2	1 3/16-12	1 7/16	36	1 3/16	30	1.74	44.1	3.27	83.1
SG-OFFX-1010	29700-1010	20821925	5/8	1-14	1 3/16	30	15/16	24	1.65	42.0	3.25	82.5
SG-OFFX-1012	29700-1012	20821924	5/8	1 3/16-12	1 7/16	36	1 3/16	30	1.75	44.5	3.35	85.0
SG-OFFX-1210	29700-1210	20821923	3/4	1-14	1 3/16	30	1 1/16	27	1.69	43.0	3.56	90.4
SG-OFFX-1212	29700-1212	20821922	3/4	1 3/16-12	1 7/16	36	1 3/16	30	1.78	45.2	3.65	92.7
SG-OFFX-1216	29700-1216	20821921	3/4	1 7/16-12	1 1/2	41	1 7/16	36	2.03	51.5	3.90	99.0
SG-OFFX-1612	29700-1612	20821920	1	1 3/16-12	1 7/16	36	1 1/4	32	1.95	49.4	4.23	107.4
SG-OFFX-1616	29700-1616	20821919	1	1 7/16-12	1 1/2	41	1 7/16	36	2.10	53.4	4.39	111.4
SG-OFFX-1620	29700-1620	20821918	1	1 11/16-12	2	50	1 1/2	41	1.99	50.5	4.27	108.5
SG-OFFX-2020	29700-2020	20926519	1 1/4	1 11/16-12	2 3/8	50	1 3/8	41	2.28	57.9	5.42	137.7
SG-OFFX-2424	29700-2424	20757721	1 1/2	2-12	2 3/8	60	2 3/8	50	2.69	68.4	6.16	156.3



Download the **MyCrimp App** for more information.

Section 2
SG Fittings





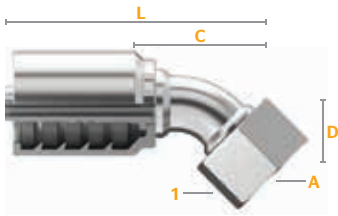

FITTINGS





O-Ring Face Seal (SAE J1453 ORS/ORFS)





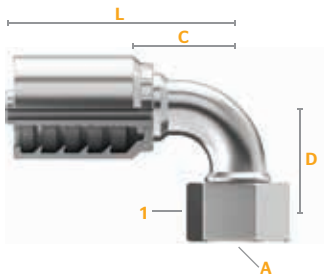

Female / 45° Elbow / Swivel

Part Number	Product Number	SAP Number										
			Hose ID	Thread Size (A)	Hex 1 Wrench Size	Drop (D)	Cut-Off (C)	Length (L)	in.	mm	in.	mm
SG-OFFX45-0606	29710-0606	20758286	3/8	11/16-16	7/8	22	0.43	11.0	1.85	47.0	3.31	84.0
SG-OFFX45-0608	29710-0608	20821917	3/8	13/16-16	15/16	24	0.59	15.0	2.01	51.1	3.47	88.1
SG-OFFX45-0808	29710-0808	20731758	1/2	13/16-16	15/16	24	0.63	16.0	1.85	47.0	3.42	86.9
SG-OFFX45-0810	29710-0810	20758300	1/2	1-14	1 3/8	30	0.63	16.0	1.97	50.0	3.51	89.0
SG-OFFX45-1010	29710-1010	20821916	5/8	1-14	1 3/8	30	0.63	16.0	1.65	42.0	3.86	98.0
SG-OFFX45-1210	29710-1210	20873194	3/4	1-14	1 3/8	30	0.79	20.1	2.16	55.0	4.04	102.5
SG-OFFX45-1212	29710-1212	20821915	3/4	1 3/8-12	1 7/8	36	0.83	21.0	2.56	64.9	4.43	112.4
SG-OFFX45-1216	29710-1216	20821914	3/4	1 3/8-12	1 3/4	41	0.95	24.0	2.80	71.1	4.67	118.6
SG-OFFX45-1616	29710-1616	20821913	1	1 3/8-12	1 3/4	41	1.02	26.0	3.15	80.0	5.43	137.9
SG-OFFX45-1620	29710-1620	20873195	1	1 3/8-12	2	50	1.26	32.0	3.35	85.1	5.63	143.1
SG-OFFX45-2020	29710-2020	20926520	1 1/4	1 3/8-12	2	50	1.02	25.9	3.82	97.0	6.95	176.6
SG-OFFX45-2024	29710-2024	20926521	1 1/4	2-12	2 3/8	60	1.1	27.9	3.62	92.0	6.76	171.6
SG-OFFX45-2424	29710-2424	20873197	1 1/2	2-12	2 3/8	60	1.65	42.0	4.8	121.9	8.27	209.9



O-Ring Face Seal (SAE J1453 ORS/ORFS)

Female / 90° Elbow / Swivel

Part Number	Product Number	SAP Number											
			Hose ID	Thread Size (A)	Hex 1 Wrench Size	Elbow Type ¹	Drop (D)	Cut-Off (C)	Length (L)	in.	mm	in.	mm
SG-OFFX90-0606	29715-0606	20731757	3/8	11/16-16	7/8	22	1.50	38.0	1.65	42.0	3.11	79.0	
SG-OFFX90L-0606	29720-0606	20731762	3/8	11/16-16	7/8	22	LT	2.13	54.0	1.65	42.0	3.11	79.0
SG-OFFX90S-0606	29725-0606	20731760	3/8	11/16-16	7/8	22	ST	0.91	23.0	1.65	42.0	3.11	79.0
SG-OFFX90-0608	29715-0608	20821911	3/8	13/16-16	15/16	24	1.61	41.0	1.73	44.0	3.19	81.0	
SG-OFFX90L-0608	29720-0608	20821904	3/8	13/16-16	15/16	24	LT	2.52	64.0	1.85	47.0	3.31	84.0
SG-OFFX90S-0608	29725-0608	20821899	3/8	13/16-16	15/16	24	ST	1.14	29.0	1.65	42.0	3.11	79.0

Continued on the next page.

FITTINGS



Section 2

SG Fittings

COMPATIBLE HOSE:

SR12 SR13 SR15 S4SP XCP3S XCP5S
ARC12 ARC13 ARC15 S4SH XCP4S XCP6S

For a detailed list, please refer to your Crimp Specifications Manual.

O-Ring Face Seal (Female 90° Elbow) Continued

Part Number	Product Number	SAP Number	Hose ID	Thread Size (A)	Hex 1		Elbow Type ²	Drop (D)		Cut-Off (C)		Length (L)	
					Wrench Size	mm		in.	mm	in.	mm	in.	mm
SG-OFFX90-0808	29715-0808	20731753	1/2	13/16-16	15/16	24		1.61	41.0	1.41	35.9	2.95	74.9
SG-OFFX90L-0808	29720-0808	20821903	1/2	13/16-16	15/16	24	LT	2.52	64.0	1.53	38.9	3.07	77.9
SG-OFFX90S-0808	29725-0808	20731756	1/2	13/16-16	15/16	24	ST	1.14	29.0	1.61	40.9	3.15	79.9
SG-OFFX90-0810	29715-0810	20821910	1/2	1-14	1 3/16	30		1.85	47.0	1.89	48.0	3.43	87.0
SG-OFFX90L-0810	29720-0810	20821902	1/2	1-14	1 3/16	30	LT	2.76	70.0	1.81	46.0	3.35	85.0
SG-OFFX90S-0810	29725-0810	20821898	1/2	1-14	1 3/16	30	ST	1.26	32.0	1.81	46.0	3.38	85.9
SG-OFFX90S-0812	29725-0812	20821897	1/2	1 3/16-12	1 7/16	36	ST	1.89	48.0	2.48	62.9	4.01	101.9
SG-OFFX90-1010	29715-1010	20821909	5/8	1-14	1 3/16	30		1.85	47.0	2.17	55.0	3.76	95.5
SG-OFFX90S-1010	29725-1010	20821896	5/8	1-14	1 3/16	30	ST	1.28	32.5	2.05	52.0	3.64	92.5
SG-OFFX90S-1012	29725-1012	20821895	5/8	1 3/16-12	1 7/16	36	ST	1.89	48.0	2.48	62.9	4.07	103.4
SG-OFFX90S-1210	29725-1210	20821894	3/4	1-14	1 3/16	30	ST	1.54	39.1	1.63	41.3	3.70	93.9
SG-OFFX90-1212	29715-1212	20821908	3/4	1 3/16-12	1 7/16	36		2.28	58.0	2.52	63.9	4.39	111.4
SG-OFFX90L-1212	29720-1212	20821901	3/4	1 3/16-12	1 7/16	36	LT	3.78	96.0	2.52	63.9	4.39	111.4
SG-OFFX90S-1212	29725-1212	20821893	3/4	1 3/16-12	1 7/16	36	ST	1.89	48.0	2.48	62.9	4.35	110.4
SG-OFFX90-1216	29715-1216	20821907	3/4	1 7/16-12	1 3/8	41		2.80	71.1	2.68	68.0	4.55	115.5
SG-OFFX90S-1216	29725-1216	20821892	3/4	1 7/16-12	1 3/8	41	ST	2.21	56.0	2.68	68.0	4.55	115.5
SG-OFFX90-1616	29715-1616	20821906	1	1 7/16-12	1 3/8	41		2.80	71.0	3.13	79.6	5.42	137.5
SG-OFFX90L-1616	29720-1616	20821900	1	1 7/16-12	1 3/8	41	LT	4.49	114.0	3.13	79.5	5.42	137.5
SG-OFFX90S-1616	29725-1616	20821891	1	1 7/16-12	1 3/8	41	ST	2.26	57.5	3.13	79.6	5.42	137.5
SG-OFFX90-1620	29715-1620	20821905	1	1 7/16-12	2	50		3.07	78.0	3.27	83.0	5.55	141.0
SG-OFFX90S-1620	29725-1620	20821890	1	1 7/16-12	2	50	ST	2.52	64.0	3.27	83.0	5.55	141.0
SG-OFFX90-2020	29715-2020	20926522	1 1/4	1 11/16-12	2	50		3.07	78.0	3.82	97.0	6.95	176.6
SG-OFFX90L-2020	29720-2020	20926524	1 1/4	1 11/16-12	2	50	LT	5.08	129.0	3.82	97.0	6.95	176.6
SG-OFFX90S-2020	29725-1620	20926526	1 1/4	1 11/16-12	2	50	ST	2.52	64.0	3.74	95.0	6.87	174.6
SG-OFFX90-2024	29715-2024	20926523	1 1/4	2-12	2 3/8	50		3.071	78.0	3.62	92.0	6.76	171.6
SG-OFFX90L-2024	29720-2024	20926525	1 1/4	2-12	2 3/8	50	LT	5.08	129.0	3.62	92.0	6.76	171.6
SG-OFFX90S-2024	29725-1624	20926527	1 1/4	2-12	2 3/8	50	ST	2.52	64.0	3.62	92.0	6.76	171.6
SG-OFFX90-2424	29715-2424	20873198	1 1/2	2-12	2 3/8	60		3.39	86.0	4.52	115.0	7.99	203.0
SG-OFFX90L-2424	29720-2424	20873199	1 1/2	2-12	2 3/8	60	LT	5.55	141.0	4.52	115.0	7.99	203.0
SG-OFFX90S-2424	29725-2424	20873200	1 1/2	2-12	2 3/8	60	ST	2.78	70.6	4.52	115.0	7.49	190.1

*Elbow Type: LT=Long Tube ST=Short Tube



Download the **MyCrimp App**
for more information.

Section 2

SG Fittings

FITTINGS



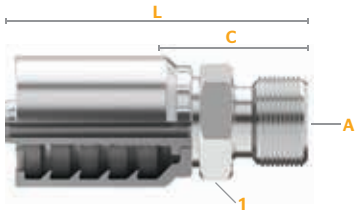

O-Ring Face Seal (SAE J1453 ORS/ORFS)

Male



Part Number	Product Number	SAP Number	Hose ID	Thread Size (A)	Hex 1 Wrench Size		Cut-Off (C)		Length (L)	
			in.		in.	mm	in.	mm	in.	mm
SG-OFM-0606	29730-0606	20758281	3/8	11/16-16	3/4	19	1.15	29.3	2.61	66.3
SG-OFM-0608	29730-0608	20821889	3/8	13/16-16	7/8	22	1.15	29.1	2.60	66.1
SG-OFM-0808	29730-0808	20758297	1/2	13/16-16	7/8	22	1.27	32.3	2.81	71.3
SG-OFM-0810	29730-0810	20821888	1/2	13/16-16	1 1/16	27	1.29	32.7	2.83	71.8
SG-OFM-0812	29730-0812	20821887	1/2	13/16-16	1 1/4	32	1.42	36.0	2.95	75.0
SG-OFM-1212	29730-1212	20821886	3/4	1 3/16-12	1 1/4	32	1.48	37.5	3.35	85.0
SG-OFM-1216	29730-1216	20821885	3/4	1 7/16-12	1 1/2	38	1.58	40.1	3.45	87.6
SG-OFM-1616	29730-1616	20821884	1	1 7/16-12	1 1/2	38	1.64	41.6	3.92	99.6
SG-OFM-2020	29730-2020	20926528	1 1/4	1 1/16-12	1 3/16	46	1.88	47.8	5.01	127.3
SG-OFM-2424	29730-2424	20873225	1 1/2	2-12	2 3/16	55	2.17	55.1	5.64	143.3

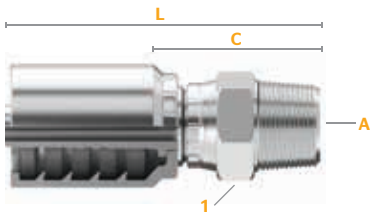

O-Ring Boss Straight Thread (SAE J514)





Male

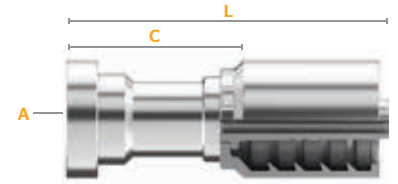

Part Number	Product Number	SAP Number	Hose ID	Thread Size (A)	Hex 1 Wrench Size		Cut-Off (C)		Length (L)	
			in.		in.	mm	in.	mm	in.	mm
SG-OBM-0606	29670-0606	20821946	3/8	9/16-18	3/4	19	1.03	26.1	2.48	63.1
SG-OBM-0608	29670-0608	20821945	3/8	3/4-16	7/8	22	1.09	27.6	2.54	64.6
SG-OBM-0610	29670-0610	20821944	3/8	7/8-14	1 1/16	27	1.18	29.9	2.64	67.0
SG-OBM-0808	29670-0808	20821943	1/2	3/4-16	7/8	22	1.09	27.6	2.62	66.6
SG-OBM-0810	29670-0810	20821942	1/2	7/8-14	1 1/16	27	1.18	29.9	2.72	69.0
SG-OBM-0812	29670-0812	20821941	1/2	1 1/16-12	1 1/4	32	1.34	34.1	2.88	73.1
SG-OBM-1210	29670-1210	20821940	3/4	7/8-14	1 1/16	27	1.24	31.4	3.11	78.9
SG-OBM-1212	29670-1212	20821939	3/4	1 1/16-12	1 1/4	32	1.40	35.6	3.27	83.1
SG-OBM-1216	29670-1216	20821938	3/4	1 3/16-12	1 1/2	38	1.48	37.6	3.35	85.1
SG-OBM-1616	29670-1616	20821937	1	1 1/16-12	1 1/2	38	1.54	39.1	3.83	97.2
SG-OBM-2020	29670-2020	20926518	1 1/4	1 3/16-12	1 3/16	46	1.78	45.2	4.91	124.8
SG-OBM-2424	29670-2424	20873224	1 1/2	1 3/16-12	2 1/8	54	2.06	52.2	5.52	140.2

Code 61 Flange (SAE J518)







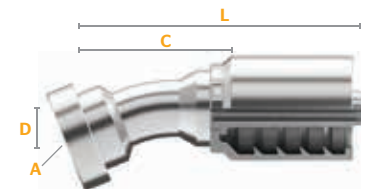

Part Number	Product Number	SAP Number								
			Hose ID	Flange Size	Flange Diameter (A)		Cut-Off (C)		Length (L)	
			in.		in.	mm	in.	mm	in.	mm
SG-FL-0808	29320-0808	20822104	1/2	1/2	1.19	30.2	1.61	40.9	3.15	79.9
SG-FL-0812	29320-0812	20822131	1/2	3/4	1.50	38.1	1.65	41.9	3.19	80.9
SG-FL-1012	29320-1012	20822102	5/8	3/4	1.50	38.1	1.71	43.3	3.30	83.8
SG-FL-1212	29320-1212	20822098	3/4	3/4	1.50	38.1	1.75	44.3	3.62	91.8
SG-FL-1216	29320-1216	20822097	3/4	1	1.75	44.5	1.99	50.5	3.86	98.0
SG-FL-1220	29320-1220	20822096	3/4	1 1/4	2.00	50.8	2.09	53.0	3.96	100.6
SG-FL-1616	29320-1616	20822094	1	1	1.75	44.5	2.09	53.1	4.37	111.1
SG-FL-1620	29320-1620	20822093	1	1 1/4	2.00	50.8	2.12	53.9	4.40	111.8
SG-FL-1624	29320-1624	20822092	1	1 1/2	2.37	60.3	2.32	58.9	4.60	116.8
SG-FL-2020	29320-2020	20926491	1 1/4	1 1/4	2.00	50.8	2.25	57.2	5.38	136.8
SG-FL-2020S	29320-2020S	20933827	1 1/4	1 1/4	2.00	50.8	2.25	57.2	5.38	136.8
SG-FL-2420	29320-2420	20873213	1 1/2	1 1/4	2.00	50.8	2.19	55.6	5.65	143.6
SG-FL-2424	29320-2424	20757499	1 1/2	1 1/2	2.38	60.3	2.91	73.8	6.45	163.9
SG-FL-2424S	29320-2424S	20933828	1 1/2	1 1/2	2.38	60.3	2.91	73.8	6.45	163.9
SG-FL-2432	29320-2432	20873214	1 1/2	2	2.81	71.4	2.76	70.1	6.23	158.1
SG-FL-3232	29320-3232	20833306	2	2	2.81	71.4	2.91	73.8	6.45	163.9
SG-FL-3232S	29320-3232S	20933829	2	2	2.81	71.4	2.91	73.8	6.45	163.9

S=Stainless Steel (See Fitting Identification in Appendix for more information.)

Code 61 Flange (SAE J518)

22.5° Elbow



Part Number	Product Number	SAP Number										
			Hose ID	Flange Size	Flange Diameter (A)		Drop (D)	Cut-Off (C)		Length (L)		
			in.		in.	mm	in.	mm	in.	mm	in.	mm
SG-FL22-0808	29330-0808	20822091	1/2	1/2	1.19	30.2	0.35	9.0	2.32	58.9	3.86	97.9
SG-FL22-1212	29330-1212	20822090	3/4	3/4	1.50	38.1	0.55	14.0	3.325	84.5	5.20	132.0
SG-FL22-1216	29330-1216	20822089	3/4	1	1.75	44.5	0.55	14.0	3.39	86.1	5.26	133.6
SG-FL22-1616	29330-1616	20822088	1	1	1.75	44.5	0.55	14.0	4.217	107.1	6.50	165.1
SG-FL22-1620	29330-1620	20822087	1	1 1/4	2.00	50.8	0.59	15.0	3.62	91.9	5.90	149.9
SG-FL22-2020	29330-2020	20926492	1 1/4	1 1/4	2.00	50.8	0.60	15.2	4.50	114.3	7.63	193.9
SG-FL22-2024	29330-2024	20926493	1 1/4	1 1/2	2.38	60.3	0.60	15.2	4.50	114.3	7.63	193.9
SG-FL22-2424	29330-2424	20873212	1 1/2	1 1/2	2.38	60.3	0.71	18.0	5.16	131.1	8.63	219.1
SG-FL22-3232	29330-3232	20873187	2	2	2.81	71.4	0.87	22.0	5.709	145.0	9.25	235.0



Download the **MyCrimp App** for more information.

Section 2
SG Fittings





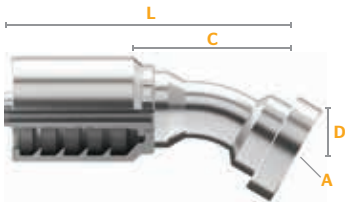

FITTINGS





Code 61 Flange (SAE J518)





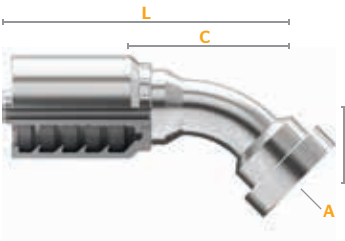

30° Elbow

Part Number	Product Number	SAP Number										
			Hose ID	Flange Size	Flange Diameter (A)		Drop (D)		Cut-Off (C)		Length (L)	
			in.		in.	mm	in.	mm	in.	mm	in.	mm
SG-FL30-1212	29335-1212	20822086	3/4	3/4	1.50	38.1	0.69	17.5	3.23	81.9	5.136	130.5
SG-FL30-1216	29335-1216	20822085	3/4	1	1.75	44.5	0.75	19.0	3.31	84.1	5.18	131.6
SG-FL30-1616	29335-1616	20822084	1	1	1.75	44.5	0.75	19.0	4.151	105.4	6.43	163.4
SG-FL30-1620	29335-1620	20822083	1	1 ¼	2.00	50.8	0.87	22.0	3.54	89.9	5.82	147.9
SG-FL30-1624	29335-1624	20822082	1	1 ½	2.37	60.3	1.06	27.0	4.213	107.0	6.49	165.0
SG-FL30-2020	29335-2020	20926494	1 ¼	1 ¼	2.00	50.8	0.87	22.0	4.25	108.0	7.38	187.6
SG-FL30-2024	29335-2024	20926495	1 ¼	1 ½	2.38	60.3	0.87	22.0	4.25	108.0	7.38	187.6
SG-FL30-2424	29335-2424	20873215	1 ½	1 ½	2.38	60.3	1.18	30.0	5.33	135.4	8.80	223.4
SG-FL30-2432	29335-2432	20873216	1 ½	2	2.81	71.4	1.18	30.0	5.33	135.4	8.80	223.4
SG-FL30-3232	29335-3232	20873188	2	2	2.81	71.4	1.26	32.0	5.71	145.0	9.25	235.0



Code 61 Flange (SAE J518)

45° Elbow

Part Number	Product Number	SAP Number										
			Hose ID	Flange Size	Flange Diameter (A)		Drop (D)		Cut-Off (C)		Length (L)	
			in.		in.	mm	in.	mm	in.	mm	in.	mm
SG-FL45-0808	29340-0808	20822081	3/4	3/4	1.50	38.1	0.98	25.0	2.72	69.0	5.24	133.0
SG-FL45-0812	29340-0812	20822080	3/4	3/4	1.50	38.1	1.10	28.0	2.80	71.0	4.96	126.0
SG-FL45-1012	29340-1012	20822079	1	1	1.75	44.5	1.38	35.0	3.27	83.0	6.30	160.0
SG-FL45-1212	29340-1212	20822078	1	1	1.75	44.5	1.38	35.0	3.46	88.0	5.98	152.0
SG-FL45-1216	29340-1216	20822077	1	1 ¼	2.00	50.8	1.18	30.0	3.78	96.0	6.77	172.0

Continued on the next page.

FITTINGS



Section 2







SG Fittings

COMPATIBLE HOSE:

SR12 SR13 SR15 S4SP XCP3S XCP5S
ARC12 ARC13 ARC15 S4SH XCP4S XCP6S

For a detailed list, please refer to your Crimp Specifications Manual.

Code 61 Flange (45° Elbow) Continued





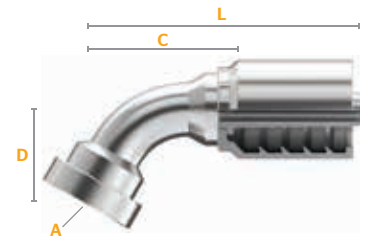

Part Number	Product Number	SAP Number										
			Hose ID	Flange Size	Flange Diameter (A)		Drop (D)		Cut-Off (C)		Length (L)	
			in.		in.	mm	in.	mm	in.	mm	in.	mm
SG-FL45-1616	29340-1616	20822076	1 ¼	1 ¼	2.00	50.8	1.28	32.5	3.98	101.0	7.40	188.0
SG-FL45-1620	29340-1620	20822075	1 ¼	1 ¼	2.00	50.8	1.52	38.5	4.09	104.0	7.87	200.0
SG-FL45-2020	29340-2020	20926496	1 ¼	1 ¼	2.00	50.8	1.50	38.1	3.88	98.4	7.01	178.0
SG-FL45-2020S	29340-2020S	20933830	1 ¼	1 ¼	2.00	50.8	1.50	38.1	3.88	98.4	7.01	178.0
SG-FL45-2024	29340-2024	20926497	1 ¼	1 ½	2.37	60.3	1.50	38.1	3.88	98.4	7.01	178.0
SG-FL45-2424	29340-2424	20757724	1 ½	1 ½	2.38	60.3	1.73	44.0	4.37	111.0	7.84	199.0
SG-FL45-2424S	29340-2424S	20933831	1 ½	1 ½	2.38	60.3	1.73	44.0	4.37	111.0	8.27	209.9
SG-FL45-2432	29340-2432	20873217	1 ½	2	2.81	71.4	1.73	44.0	4.37	111.0	8.27	209.9
SG-FL45-3232	29340-3232	20873189	2	2	2.81	71.4	2.21	56.0	6.10	155.0	9.65	245.0
SG-FL45-3232S	29340-3232S	20933832	2	2	2.81	71.4	2.21	56.0	6.10	155.0	9.65	245.0

S=Stainless Steel (See Fitting Identification in Appendix for more information.)

Code 61 Flange (SAE J518)

60° Elbow



Part Number	Product Number	SAP Number										
			Hose ID	Flange Size	Flange Diameter (A)		Drop (D)		Cut-Off (C)		Length (L)	
			in.		in.	mm	in.	mm	in.	mm	in.	mm
SG-FL60-1212	29345-1212	20822074	3/4	3/4	1.50	38.1	1.46	37.1	3.47	88.0	5.336	135.5
SG-FL60-1216	29345-1216	20822073	3/4	1	1.75	44.5	1.73	44.0	3.46	87.9	5.33	135.4
SG-FL60-1616	29345-1616	20822072	1	1	1.75	44.5	1.73	44.0	4.15	105.4	6.43	163.4
SG-FL60-1620	29345-1620	20822071	1	1 ¼	2.00	50.8	2.17	55.0	4.2	106.7	6.48	164.7
SG-FL60-2020	29345-2020	20926498	1 ¼	1 ¼	2.00	50.8	2.20	55.9	5.13	130.2	8.26	209.8
SG-FL60-2024	29345-2024	20926499	1 ¼	1 ½	2.37	60.3	2.20	55.9	5.13	130.2	8.26	209.8
SG-FL60-2424	29345-2424	20873218	1 ½	1 ½	2.37	60.3	2.52	64.0	5.35	135.9	8.82	223.9
SG-FL60-2432	29345-2432	20873219	1 ½	2	2.81	71.4	2.52	64.0	5.35	135.9	8.82	223.9
SG-FL60-3232	29345-3232	20873190	2	2	2.81	71.4	3.27	83.0	5.71	145.0	9.25	235.0



Download the **MyCrimp App** for more information.

Section 2
SG Fittings





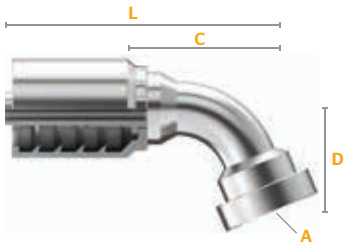

FITTINGS





Code 61 Flange (SAE J518)





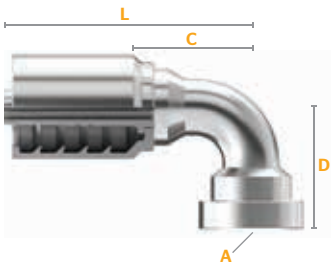

67° Elbow

Part Number	Product Number	SAP Number										
			Hose ID	Flange Size	Flange Diameter (A)		Drop (D)		Cut-Off (C)		Length (L)	
			in.		in.	mm	in.	mm	in.	mm	in.	mm
SG-FL67-1212	29347-1212	20822070	3/4	3/4	1.50	38.1	1.65	42.0	3.17	80.4	5.04	127.9
SG-FL67-1216	29347-1216	20822069	3/4	1	1.75	44.5	2.01	51.0	3.46	87.9	5.33	135.4
SG-FL67-1616	29347-1616	20822068	1	1	1.75	44.5	2.4	61.0	3.84	97.6	6.13	155.6
SG-FL67-1620	29347-1620	20822067	1	1 ¼	2.00	50.8	2.52	64.0	3.88	98.6	6.16	156.5
SG-FL67-2020	29347-2020	20926500	1 ¼	1 ¼	2.00	50.8	2.50	63.5	4.50	114.3	7.63	193.9
SG-FL67-2024	29347-2024	20926501	1 ¼	1 ½	2.37	60.3	2.50	63.5	4.50	114.3	7.63	193.9
SG-FL67-2424	29347-2424	20873220	1 ½	1 ½	2.37	60.3	2.91	74.0	5.33	135.4	8.80	223.4
SG-FL67-2432	29347-2432	20873221	1 ½	2	2.81	71.4	2.91	74.0	5.33	135.4	8.80	223.4
SG-FL67-3232	29347-3232	20873191	2	2	2.81	71.4	3.82	97.0	6.30	160.0	9.84	250.0



Code 61 Flange (SAE J518)

90° Elbow

Part Number	Product Number	SAP Number										
			Hose ID	Flange Size	Flange Diameter (A)		Drop (D)		Cut-Off (C)		Length (L)	
			in.		in.	mm	in.	mm	in.	mm	in.	mm
SG-FL90-0808	29350-0808	20758301	1/2	1/2	1.19	30.2	1.63	41.5	1.89	48.0	3.43	87.0
SG-FL90-0812	29350-0812	20822066	1/2	3/4	1.50	38.1	2.28	55.0	1.89	63.0	3.43	127.0
SG-FL90-1212	29350-1212	20822065	3/4	3/4	1.50	38.1	2.28	58.0	2.36	65.0	4.23	112.5
SG-FL90L-1212	29352-1212	20873193	3/4	3/4	1.50	38.1	5.24	133.0	2.56	65.0	4.43	112.5
SG-FL90-100-1212	29350A-1212	20873157	3/4	3/4	1.50	38.1	3.94	100.0	2.36	59.8	4.23	107.3
SG-FL90-1216	29350-1216	20822064	3/4	1	1.75	44.5	2.76	59.0	2.60	64.0	2.60	128.0
SG-FL90L-1216	29352-1216	20822059	3/4	1	1.75	38.1	6.06	55.0	2.60	69.0	4.47	133.0
SG-FL90-1220	29352-1220	20959263	3/4	1 ¼	2.00	50.8	2.45	62.2	2.75	69.9	4.62	117.3

Continued on the next page.

FITTINGS



Section 2

SG Fittings

COMPATIBLE HOSE:

SR12 SR13 SR15 S4SP XCP3S XCP5S
ARC12 ARC13 ARC15 S4SH XCP4S XCP6S

For a detailed list, please refer to your Crimp Specifications Manual.

Code 61 Flange (90° Elbow) Continued

Part Number	Product Number	SAP Number	Hose ID	Flange Size	Flange Diameter (A)		Drop (D)		Cut-Off (C)		Length (L)	
					in.	mm	in.	mm	in.	mm	in.	mm
SG-FL90-1612	29350-1612	20822063	1	3/4	1.50	38.1	2.284	58.0	2.63	66.7	4.91	124.7
SG-FL90-1616	29350-1616	20822062	1	1	1.75	44.5	2.76	64.0	2.97	72.0	5.25	149.0
SG-FL90L-1616	29352-1616	20822058	1	1	1.75	44.5	6.06	64.0	3.97	78.0	6.25	142.0
SG-FL90-120-1616	29350A-1616	20873158	1	1	1.75	44.5	4.72	120.0	2.97	75.4	5.25	133.4
SG-FL90-150-1616		20923047	1	1	1.75	44.5	6.06	154.0	3.97	100.8	6.25	158.8
SG-FL90-1620	29350-1620	20822061	1	1 ¼	2.00	50.8	3.54	90.0	3.07	78.0	5.35	136.0
SG-FL90-1624	29350-1624	20822060	1	1 ½	2.38	44.5	2.95	64.0	3.74	78.0	6.02	142.0
SG-FL90-2016	29350-2016	20926502	1 ¼	1	1.75	44.5	2.76	70.1	3.35	85.1	6.48	164.7
SG-FL90-2020	29350-2020	20926503	1 ¼	1 ¼	2.00	50.8	3.50	88.9	3.62	92.0	6.76	171.6
SG-FL90-2020S	29350-2020S	20933833	1 ¼	1 ¼	2.00	50.8	3.50	88.9	3.62	92.0	6.76	171.6
SG-FL90-2024	29350-2024	20926504	1 ¼	1 ½	2.38	44.5	3.50	88.9	3.62	92.0	6.76	171.6
SG-FL90-2424	29350-2424	20757723	1 ½	1 ½	2.38	44.5	4.10	104.0	4.13	104.9	7.60	192.9
SG-FL90-2424S	29350-2424S	20933834	1 ½	1 ½	2.38	44.5	4.10	104.0	4.13	104.9	7.99	203.0
SG-FL90-2432	29350-2432	20873222	1 ½	2	2.81	71.4	4.10	104.0	4.13	104.9	7.99	203.0
SG-FL90-3232	29350-3232	20873192	2	2	2.81	71.4	5.43	138.0	5.71	145.0	9.25	235.0
SG-FL90-3232S	29350-3232s	20933835	2	2	2.81	71.4	5.43	138.0	5.71	145.0	9.25	235.0

S=Stainless Steel (See Fitting Identification in Appendix for more information.)

Code 61 Flange (SAE J518)

110° Elbow

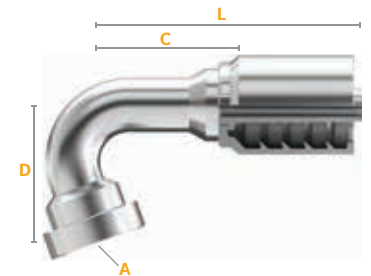

Part Number	Product Number	SAP Number	Hose ID	Flange Size	Flange Diameter (A)		Drop (D)		Cut-Off (C)		Length (L)	
					in.	mm	in.	mm	in.	mm	in.	mm
SG-FL110-1212	29354-1212	20822101	3/4	3/4	1.50	38.1	2.76	70.1	2.52	63.9	4.39	111.4
SG-FL110-1216	29354-1216	20822100	3/4	1	1.75	44.5	2.91	73.9	2.25	57.2	4.12	104.6
SG-FL110-1616	29354-1616	20822099	1	1	1.75	44.5	3.11	79.0	3.81	96.8	6.09	154.8
SG-FL110-2424	29354-2424	20873211	1 ¼	1 ½	2.38	60.6	4.33	110.0	3.74	95.0	7.21	183.0



Download the **MyCrimp App** for more information.

Section 2
SG Fittings

FITTINGS



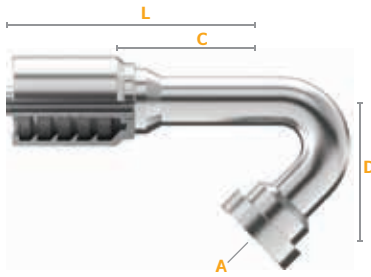

Code 61 Flange (SAE J518)

135° Elbow



Part Number	Product Number	SAP Number	Flange Size		Flange Diameter (A)		Drop (D)		Cut-Off (C)		Length (L)	
			Hose ID	Flange Size	in.	mm	in.	mm	in.	mm	in.	mm
SG-FL135-1212	29355-1212	20822095	3/4	3/4	1.50	38.1	3.15	80.0	2.83	71.8	4.70	119.3

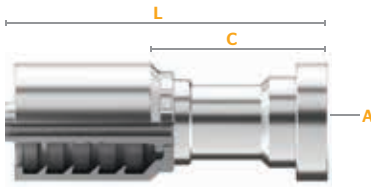

Code 62 Flange (SAE J518)







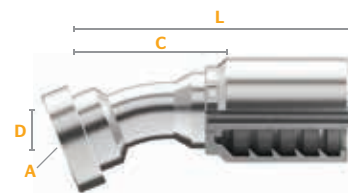

Part Number	Product Number	SAP Number	Flange Size		Flange Diameter (A)		Cut-Off (C)		Length (L)	
			Hose ID	Flange Size	in.	mm	in.	mm	in.	mm
SG-FH0808	29300-0808	20822132	1/2	1/2	1.25	31.8	1.879	47.7	3.41	86.7
SG-FH0812	29300-0812	20822131	1/2	3/4	1.63	41.3	2.07	52.8	3.61	91.8
SG-FH-1212	29300-1212	20822130	3/4	3/4	1.63	41.3	2.14	54.5	4.01	102.0
SG-FH-1216	29300-1216	20822129	3/4	1	1.88	47.6	2.23	56.8	4.105	104.3
SG-FH-1612	29300-1612	20822128	1	3/4	1.63	41.3	2.30	58.4	4.58	116.4
SG-FH-1616	29300-1616	20822127	1	1	1.88	47.6	2.28	58.0	4.56	116.0
SG-FH-1620	29300-1620	20822126	1	1 1/4	2.13	54.0	2.58	65.5	4.86	123.5
SG-FH-2016	29300-2016	20926477	1 1/4	1	1.87	47.6	3.26	82.9	6.40	162.5
SG-FH-2020	29300-2020	20926478	1 1/4	1 1/4	2.13	54.0	2.53	64.2	5.68	144.3
SG-FH-2024	29300-2024	20926479	1 1/4	1 1/2	2.50	63.5	2.99	76.0	6.13	155.6
SG-FH-2424	29300-2424	20757743	1 1/2	1 1/2	2.50	63.5	2.99	76.0	6.46	164.0
SG-FH-2432	29320-2432	20757726	1 1/2	2	3.13	79.4		Contact Continental		
SG-FH-3232	29300-3232	20833307	1	2	3.13	79.4	5.19	131.9	8.73	221.9

Code 62 Flange (SAE J518)

22.5° Elbow







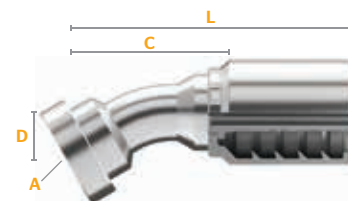

Part Number	Product Number	SAP Number										
			Hose ID	Flange Size	Flange Diameter (A)	Drop (D)	Cut-Off (C)	Length (L)				
			in.		in.	mm	in.	mm	in.	mm	in.	mm
SG-FH22-1212	29303-1212	20822125	3/4	3/4	1.63	41.3	0.55	41.3	3.33	41.3	5.20	41.3
SG-FH22-1216	29303-1216	20822124	3/4	1	1.88	41.3	0.59	41.3	3.39	41.3	5.26	41.3
SG-FH22-1616	29303-1616	20822123	1	1	1.88	41.3	0.55	41.3	4.22	41.3	6.50	41.3
SG-FH22-2020	29303-2020	20926480	1 1/4	1 1/4	2.13	54.0	0.60	15.2	4.50	114.3	7.63	193.9
SG-FH22-2024	29303-2024	20926481	1 1/4	1 1/2	2.50	63.5	0.73	18.5	4.50	114.3	7.63	193.9

Code 62 Flange (SAE J518)

30° Elbow



Part Number	Product Number	SAP Number										
			Hose ID	Flange Size	Flange Diameter (A)	Drop (D)	Cut-Off (C)	Length (L)				
			in.		in.	mm	in.	mm	in.	mm	in.	mm
SG-FH30-1212	29305-1212	20822122	3/4	3/4	1.63	41.3	0.73	18.5	3.27	83.0	5.14	130.5
SG-FH30-1616	29305-1616	20822121	1	1	1.87	47.6	0.75	19.0	4.15	105.4	6.43	163.4
SG-FH30-2020	29305-2020	20926482	1 1/4	1 1/4	2.13	54.0	0.87	22.0	4.25	108.0	7.38	187.6
SG-FH30-2024	29305-2024	20926483	1 1/4	1 1/2	2.50	63.5	1.02	25.8	4.25	108.0	7.38	187.6
SG-FH30-2424	29305-2424	20757730	1 1/2	1 1/2	2.50	63.5	1.18	30.0	5.33	135.4	8.79	223.4
SG-FH30-3232	29305-3232	20873183	2	2	2.81	71.4	1.32	33.5	5.71	145.0	9.25	235.0



Download the **MyCrimp App** for more information.

Section 2
SG Fittings





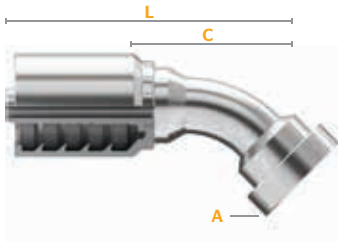

FITTINGS





Code 62 Flange (SAE J518)





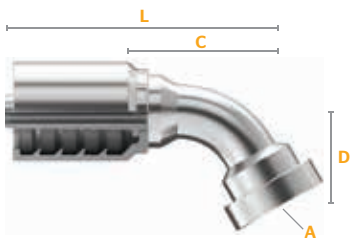

45° Elbow

Part Number	Product Number	SAP Number										
			Hose ID	Flange Size	Flange Diameter (A)		Drop (D)		Cut-Off (C)		Length (L)	
			in.		in.	mm	in.	mm	in.	mm	in.	mm
SG-FH45-0808	29310-0808	20822120	1/2	1/2	1.25	31.8	0.86	21.8	2.24	56.9	3.775	95.9
SG-FH45-0812	29310-0812	20822119	1/2	3/4	1.63	41.4	1.083	27.5	2.99	75.8	4.521	114.8
SG-FH45-1212	29310-1212	20822118	3/4	3/4	1.63	41.4	1.12	28.5	2.99	75.8	4.86	123.3
SG-FH45-1216	29310-1216	20822117	3/4	1	1.88	47.6	1.26	32.0	3.07	78.0	4.94	125.5
SG-FH45-1612	29310-1612	20873184	1	3/4	1.63	41.4	1.12	28.5	2.99	75.8	5.27	133.8
SG-FH45-1616	29310-1616	20822116	1	1	1.88	47.6	1.26	32.0	3.842	97.6	6.12	155.6
SG-FH45-1620	29310-1620	20822115	1	1 1/4	2.13	54.1	1.49	38.0	3.78	96.0	6.06	154.0
SG-FH45-2020	29310-2020	20926484	1 1/4	1 1/4	2.13	54.0	1.50	38.1	4.02	102.0	7.15	181.6
SG-FH45-2024	29310-2024	20926485	1 1/4	1 1/2	2.50	63.5	1.63	41.4	4.13	105.0	7.27	184.6
SG-FH45-2424	29310-2424	20757720	1 1/2	1 1/2	2.50	Contact Continental	1.73	44.0	4.80	121.9	8.27	209.9
SG-FH45-2432	29340-2432	20757725	1 1/2	2	3.13		2.05	52.1	4.87	123.7	8.34	211.7
SG-FH45-3232	29340-3232	20873185	2	2	3.13	Contact Continental	2.21	56.0	6.10	155.0	9.65	245.0



Code 62 Flange (SAE J518)

60° Elbow

Part Number	Product Number	SAP Number										
			Hose ID	Flange Size	Flange Diameter (A)		Drop (D)		Cut-Off (C)		Length (L)	
			in.		in.	mm	in.	mm	in.	mm	in.	mm
SG-FH60-1212	29312-1212	20822114	3/4	3/4	1.63	41.3	1.55	39.4	3.47	88.0	5.34	135.5
SG-FH60-1616	29312-1616	20822113	1	1	1.87	47.6	1.73	44.0	4.15	105.4	6.43	163.4
SG-FH60-2020	29312-2020	20926486	1 1/4	1 1/4	2.13	54.0	2.20	55.9	5.13	130.2	8.6	209.8
SG-FH60-2024	29312-2024	20926487	1 1/4	1 1/2	2.50	63.5	2.26	57.4	5.13	130.2	8.26	209.8

FITTINGS



Section 2

SG Fittings

COMPATIBLE HOSE:





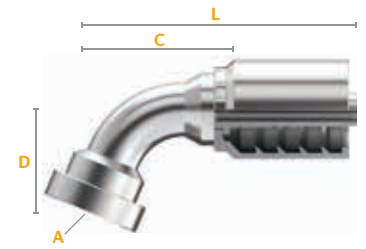

SR12 SR13 SR15 S4SP XCP3S XCP5S
 ARC12 ARC13 ARC15 S4SH XCP4S XCP6S

For a detailed list, please refer to your Crimp Specifications Manual.

Code 62 Flange (SAE J518)

67° Elbow







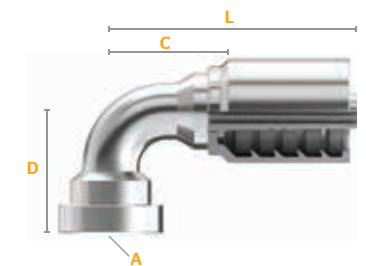

Part Number	Product Number	SAP Number										
			Hose ID	Flange Size	Flange Diameter (A)		Drop (D)		Cut-Off (C)		Length (L)	
			in.		in.	mm	in.	mm	in.	mm	in.	mm
SG-FH67-1616	29313-1616	20822112	1	1	1.87	47.6	2.40	61.0	3.84	97.6	6.13	155.6
SG-FH67-2020		20926529	1 ¼	1 ¼	2.13	54.0	2.50	63.5	4.50	114.3	7.63	193.9
SG-FH67-2024		20926530	1 ¼	1 ¼	2.50	63.5	2.57	65.2	4.50	114.3	7.63	193.9

Code 62 Flange (SAE J518)

90° Elbow



Part Number	Product Number	SAP Number											
			Hose ID	Flange Size	Flange Diameter (A)		Elbow Type*	Drop (D)		Cut-Off (C)		Length (L)	
			in.		in.	mm		in.	mm	in.	mm	in.	mm
SG-FH90-0808	29315-0808	20731761	1/2	1/2	1.25	31.8		1.67	42.4	1.89	48.0	3.43	87.0
SG-FH90-080-0808	29317A-0808	20833294	1/2	1/2	1.25	31.8	LT	3.15	80.0	1.99	50.5	3.53	89.5
SG-FH90-0812	29315-0812	20822111	1/2	3/4	1.63	41.4		2.28	58.0	1.89	48.0	3.43	87.0
SG-FH90-1012	29315-1012	20822110	5/8	3/4	1.63	41.4		2.28	58.0	1.97	50.0	3.56	90.5
SG-FH90-1212	29315-1212	20822109	3/4	3/4	1.63	41.3		2.28	58.0	2.36	59.8	4.23	107.3
SG-FH90-100-1212	29317A-1212	20833293	3/4	3/4	1.63	41.3	LT	3.94	100.0	2.40	61.0	4.27	108.5
SG-FH90-122-1212	29317B-1212	20833292	3/4	3/4	1.63	41.3	LT	4.80	122.0	2.80	71.1	4.67	118.6
SG-FH90-1216	29315-1216	20822108	3/4	1	1.88	47.6		2.76	70.0	2.60	66.0	4.47	113.5
SG-FH90-140-1216	29317A-1216	20833291	3/4	1	1.88	47.6	LT	5.51	140.0	2.56	65.0	4.43	112.5
SG-FH90-1612	29315-1612	20822107	1	3/4	1.63	41.3		2.28	58.0	2.87	72.9	5.15	130.9
SG-FH90-1616	29315-1616	20822106	1	1	1.88	47.6		2.76	70.1	2.97	75.4	5.25	133.4
SG-FH90-090-1616	29317A-1616	20833290	1	1	1.88	47.6	LT	3.54	90.0	3.28	83.3	5.56	141.3
SG-FH90-120-1616	29317B-1616	20833229	1	1	1.88	47.6	LT	4.72	120.0	3.04	77.2	5.32	135.2
SG-FH90-1620	29315-1620	20822105	1	1 ¼	2.13	54.0		3.54	90.0	3.07	78.0	5.35	136.0
SG-FH90-2016	29315-2016	20926488	1 ¼	1	1.88	47.6		2.76	70.1	3.35	85.1	6.48	164.7
SG-FH90-2020	29315-2020	20926489	1 ¼	1 ¼	2.13	54.0		3.50	88.9	3.62	92.0	6.76	171.6
SG-FH90-2024	29315-2024	20926490	1 ¼	1 ½	2.50	63.5		3.50	88.9	3.62	92.0	6.76	171.6
SG-FH90-2424	29315-2424	20757498	1 ½	1 ½	2.50	63.5		4.10	104.0	4.53	115.0	7.99	203.0
SG-FH90-2432	29315-2432	20757729	1 ½	2	3.13	79.4		4.50	114.3	4.13	104.9	7.60	192.9
SG-FH90-3232	29315-3232	20873186	2	2	3.13	79.4		5.43	138.0	5.71	145.0	9.25	235.0

*Elbow Type: LT=Long Tube



Download the **MyCrimp App** for more information.



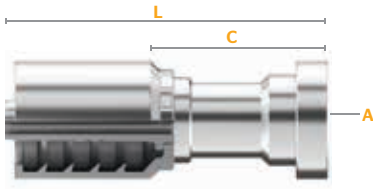

Section 2
SG Fittings

FITTINGS









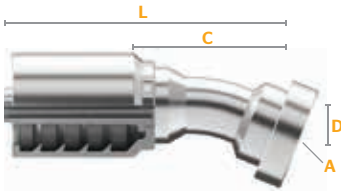

Caterpillar® Flange

Part Number	Product Number	SAP Number								
			Hose ID	Flange Size	Flange Diameter (A)	Cut-Off (C)		Length (L)		
			in.		in.	mm	in.	mm	in.	mm
SG-CF-1212	29185-1212	20822200	3/4	3/4	1.63	41.3	3.38	85.8	5.25	133.2
SG-CF-1216	29185-1216	20822199	3/4	1	1.88	47.6	3.50	88.9	5.37	136.4
SG-CF-1612	29185-1612	20822198	1	3/4	1.63	41.3	3.47	88.0	5.75	146.0
SG-CF-1616	29185-1616	20822197	1	1	1.88	47.6	3.69	93.8	6.00	152.3
SG-CF-1620	29185-1620	20822196	1	1 ¼	2.13	54.0	3.62	92.0	5.91	150.0
SG-CF-2020	29185-2020	20926460	1 ¼	1 ¼	2.13	54.0	2.55	64.7	5.68	144.3
SG-CF-2024	29185-2024	20926461	1 ¼	1 ½	2.50	63.5	3.58	91.0	6.72	170.6
SG-CF-2424	29185-2424	20873206	1 ½	1 ½	2.50	63.5	3.51	89.0	6.97	177.0
SG-CF-2432	29185-2432	20873226	1 ½	2	3.13	79.4	4.48	113.9	8.03	203.9
SG-CF-3232	29185-3232	20833299	2	2	3.13	79.4	4.48	113.9	8.03	203.9



Caterpillar® Flange

22.5° Elbow

Part Number	Product Number	SAP Number										
			Hose ID	Flange Size	Flange Diameter (A)	Drop (D)		Cut-Off (C)		Length (L)		
			in.		in.	mm	in.	mm	in.	mm		
SG-CF22-1212	29187-1212	20822195	3/4	3/4	1.63	41.3	0.63	16.0	3.25	82.6	5.20	132.0
SG-CF22-1616	29187-1616	20822194	1	1	1.88	47.6	0.71	18.0	4.22	107.1	6.50	165.1
SG-CF22-1620	29187-1620	20822193	1	1 ¼	2.13	54.0	0.71	18.0	4.29	109.0	6.57	167.0
SG-CF22-2020	29187-2020	20926462	1 ¼	1 ¼	2.13	54.0	0.77	19.6	4.50	114.3	7.63	193.9
SG-CF22-2024	29187-2024	20926463	1 ¼	1 ½	2.50	63.5	0.76	19.3	4.50	114.3	7.63	193.9

FITTINGS



Section 2

SG Fittings

COMPATIBLE HOSE:





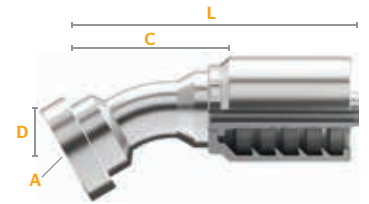

SR12 SR13 SR15 S4SP XCP3S XCP5S
ARC12 ARC13 ARC15 S4SH XCP4S XCP6S

For a detailed list, please refer to your Crimp Specifications Manual.

Caterpillar® Flange

30° Elbow







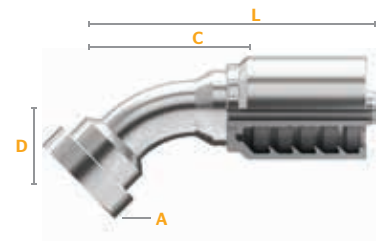

Part Number	Product Number	SAP Number										
			Hose ID	Flange Size	Flange Diameter (A)		Drop (D)		Cut-Off (C)		Length (L)	
			in.		in.	mm	in.	mm	in.	mm	in.	mm
SG-CF30-1216	29188-1216	20822192	3/4	1	1.87	47.6	0.875	22.2	3.82	97.0	5.69	144.5
SG-CF30-2020	29188-2020	20926464	1 ¼	1 ¼	2.13	54.0	0.97	24.6	4.25	108.0	7.38	187.6
SG-CF30-2024	29188-2024	20926465	1 ¼	1 ½	2.50	63.5	1.06	26.8	4.25	108.0	7.38	187.6

Caterpillar® Flange

45° Elbow



Part Number	Product Number	SAP Number										
			Hose ID	Flange Size	Flange Diameter (A)		Drop (D)		Cut-Off (C)		Length (L)	
			in.		in.	mm	in.	mm	in.	mm	in.	mm
SG-CF45-1212	29190-1212	20822191	3/4	3/4	1.63	41.4	1.34	34.0	2.99	75.8	4.86	123.3
SG-CF45-1216	29190-1216	20822190	3/4	1	1.88	47.6	1.34	34.0	3.50	88.9	5.37	136.4
SG-CF45-1616	29190-1616	20822189	1	1	1.87	47.6	1.57	39.9	3.84	97.6	6.13	155.6
SG-CF45-1620	29190-1620	20822188	1	1 ¼	2.13	54.0	1.50	38.0	3.86	98.0	6.14	156.0
SG-CF45-2020	29190-2020	20926466	1 ¼	1 ½	2.50	63.5	1.63	41.3	4.10	104.0	7.23	183.6
SG-CF45-2024	29190-2024	20926467	1 ¼	1 ½	2.50	63.5	1.69	42.8	4.17	106.0	7.31	185.6







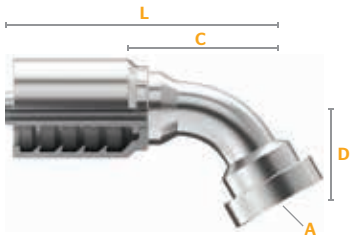

Download the **MyCrimp App** for more information.

Section 2
SG Fittings



Caterpillar® Flange





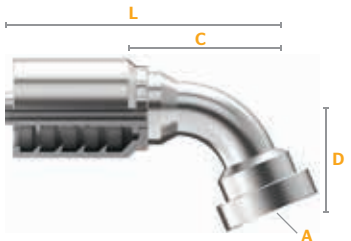

60° Elbow

Part Number	Product Number	SAP Number										
			Hose ID	Flange Size	Flange Diameter (A)		Drop (D)		Cut-Off (C)		Length (L)	
			in.		in.	mm	in.	mm	in.	mm	in.	mm
SG-CF60-1616	29192-1616	20822187	1	1	1.87	47.6	2.09	53.1	4.15	105.4	6.43	163.4
SG-CF60-1620	29192-1620	20822186	1	1 ¼	2.13	54.0	2.17	55.0	4.45	113.0	6.73	171.0
SG-CF60-2020	29192-2020	20926468	1 ¼	1 ¼	2.13	54.4	2.20	55.9	5.13	130.2	8.26	209.8
SG-CF60-2024	29192-2024	20926469	1 ¼	1 ½	2.50	63.5	2.33	59.2	5.13	130.2	8.26	209.8



Caterpillar® Flange





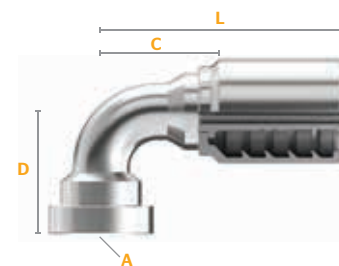

67° Elbow

Part Number	Product Number	SAP Number										
			Hose ID	Flange Size	Flange Diameter (A)		Drop (D)		Cut-Off (C)		Length (L)	
			in.		in.	mm	in.	mm	in.	mm	in.	mm
SG-CF67-2020	29194-2020	20926470	1 ¼	1 ¼	2.13	54.4	2.50	63.5	4.50	114.3	7.63	193.9
SG-CF67-2024	29194-2024	20926471	1 ¼	1 ½	2.50	63.5	2.64	67.1	4.50	114.3	7.63	193.9

Caterpillar® Flange

90° Elbow





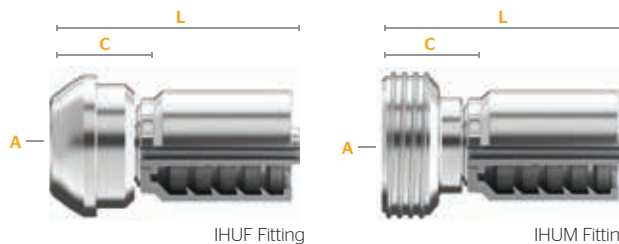

Part Number	Product Number	SAP Number											
			Hose ID	Flange Size	Flange Diameter (A)	mm	Drop (D)	in.	mm	Cut-Off (C)	in.	mm	Length (L)
SG-CF90-1212	29195-1212	20822185	3/4	3/4	1.63	41.3		2.60	66.0	2.36	59.8	4.22	107.3
SG-CF90-128-1212		20873154	3/4	3/4	1.63	41.3	LT	5.04	128.0	2.36	59.8	4.22	107.3
SG-CF90-1216	29195-1216	20822184	3/4	1	1.63	41.3		2.76	70.1	2.65	67.3	4.52	114.8
SG-CF90-1616	29195-1616	20822183	1	1	1.87	47.6		3.11	79.0	2.97	75.4	5.25	133.4
SG-CF90L-1616	29197-1616	20822181	1	1	1.87	47.6	LT	5.20	132.1	3.35	85.1	5.63	143.1
SG-CF90-132-1616		20873155	1	1	1.87	47.6	LT	5.20	132.0	2.97	75.4	5.25	133.4
SG-CF90-1620	29195-1620	20822182	1	1 1/4	2.13	54.0		3.54	90.0	3.07	78.0	5.35	136.0
SG-CF90-132-1620		20873156	1	1 1/4	2.13	54.0	LT	5.20	132.0	3.07	78.0	5.35	136.0
SG-CF90-2020	29195-2020	20926472	1 1/4	1 1/4	2.13	54.0		3.50	88.9	3.62	92.0	6.76	171.6
SG-CF90-2024	29195-2024	20926473	1	1 1/4	2.13	54.0		3.50	88.9	3.62	92.0	6.76	171.6

*Elbow Type: LT=Long Tube

Hammer Union



Part Number	Product Number	SAP Number						
			Hose ID	Thread Size (A)	in.	mm	in.	mm
SG-IHUF1502-1616	29390-1616	20873151	1	1-11 1/2 ACME-2G 3.5 TPI	2.29	58.0	4.57	116.1
SG-IHUM1502-1616	29395-1616	20873152	1	1-11 1/2 ACME-2G 3.5 TPI	2.25	57.2	4.54	115.2
SG-IHUF1502-2432	29390-2432	20851716	1 1/2	2-11 1/2 ACME-2G 3 TPI	3.09	78.5	6.56	166.5
SG-IHUM1502-2432	29395-2432	20851717	1 1/2	2-11 1/2 ACME-2G 3 TPI	2.83	71.9	6.30	159.9



Download the **MyCrimp App** for more information.



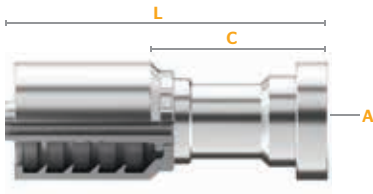

Section 2
SG Fittings

FITTINGS









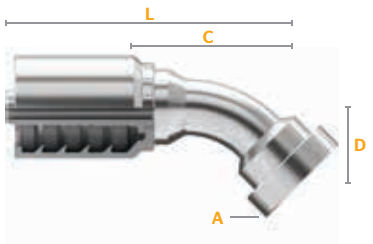

Komatsu® Flange

Part Number	Product Number	SAP Number								
			Hose ID	Flange Size	Flange Diameter (A)		Cut-Off (C)		Length (L)	
			in.		in.	mm	in.	mm	in.	mm
SG-KF-0810	29530-0810	20821988	1/2	5/8	1.34	34.0	1.83	46.6	3.39	86.1
SG-KF-1010	29530-1010	20821987	5/8	5/8	1.34	34.0	1.84	46.8	3.44	87.3
SG-KF-1210	29530-1210	20821986	3/4	5/8	1.34	34.0	1.99	50.5	3.86	98.0



Komatsu® Flange





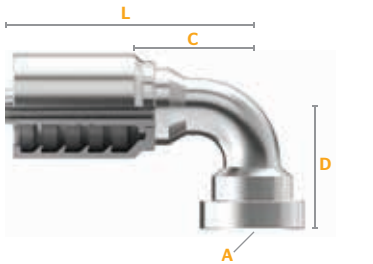

45° Elbow

Part Number	Product Number	SAP Number										
			Hose ID	Flange Size	Flange Diameter (A)		Drop (D)	Cut-Off (C)		Length (L)		
			in.		in.	mm	in.	mm	in.	mm	in.	mm
SG-KF45-1010	29535-1010	20821985	5/8	5/8	1.34	34.0	0.98	24.9	2.32	58.9	3.91	99.4



Komatsu® Flange





90° Elbow

Part Number	Product Number	SAP Number										
			Hose ID	Flange Size	Flange Diameter (A)		Drop (D)	Cut-Off (C)		Length (L)		
			in.		in.	mm	in.	mm	in.	mm	in.	mm
SG-KF90-1010	29540-1010	20821984	5/8	5/8	1.34	34.0	2.01	51.1	1.97	50.0	3.56	90.5
SG-KF90-1210	29540-1210	20821983	3/4	5/8	1.34	34.0	2.01	51.1	2.17	55.1	4.04	102.6

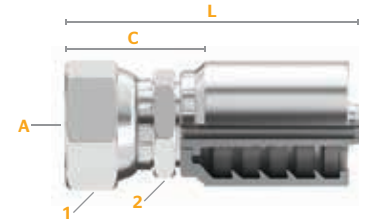
BSPB (British Standard Pipe Parallel)

Female / Swivel







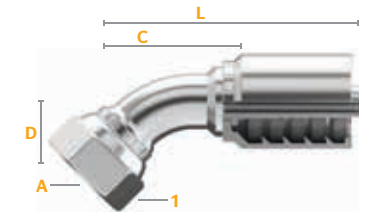

Part Number	Product Number	SAP Number							
			Hose ID	Thread Size (A)	Hex 1 Wrench Size	Cut-Off (C)		Length (L)	
			in.		mm	in.	mm	in.	mm
SG-BPFX-0608	29105-0608	20822223	3/8	1/2-14	27	1.04	26.3	2.49	63.3
SG-BPFX-0808	29105-0808	20731754	1/2	1/2-14	27	1.22	31.0	2.54	64.4
SG-BPFX-0810	29105-0810	20822222	1/2	5/8-14	27	1.15	29.2	2.38	60.5
SG-BPFX-1010	29105-1010	20959261	5/8	5/8-14	27	1.17	29.7	2.67	67.80
SG-BPFX-1212 ^T	29105-1212	20822221	3/4	3/4-14	32	1.39	35.2	3.26	82.7
SG-BPFX-1616 ^T	29105-1616	20822220	1	1-11	38	1.63	41.4	3.91	99.3
SG-BPFX-2020	29105-2020	20926356	1 1/4	1 1/4-11	41	2.39	60.7	5.53	140.5
SG-BPFX-2424	29105-2424	20757733	1 1/2	1 1/2-11	55	2.80	71.1	6.26	159.1
SG-BPFX-3232	29105-3232	20833296	2	2-11	70	2.54	64.5	6.09	154.6

T=Thrust-Wire Nut (See Fitting Identification in Appendix for more information.)

BSPB (British Standard Pipe Parallel)

Female / 45° Elbow / Swivel



Part Number	Product Number	SAP Number									
			Hose ID	Thread Size (A)	Hex 1 Wrench Size	Drop (D)		Cut-Off (C)		Length (L)	
			in.		mm	in.	mm	in.	mm	in.	mm
SG-BPFX45-0808	29115-0808	20822218	1/2	1/2-14	27	0.83	21.1	2.17	55.1	3.71	94.1
SG-BPFX45-1212 ^T	29115-1212	20822217	3/4	3/4-14	32	1.08	27.4	2.79	70.8	4.91	124.8
SG-BPFX45-1616 ^T	29115-1616	20822216	1	1-11	38	1.34	34.0	3.31	84.1	5.59	142.1
SG-BPFX45-2020	29115-2020	20926357	1 1/4	1 1/4-11	50	1.57	39.9	4.09	104.0	7.23	183.6
SG-BPFX45-2424	29115-2424	20757734	1 1/2	1 1/2-11	55	1.81	46.0	4.84	123.0	8.31	211.0
SG-BPFX45-3232	29115-3232	20873179	2	2-11	70	2.76	70.1	6.54	166.2	10.10	256.2

T=Thrust-Wire Nut (See Fitting Identification in Appendix for more information.)



Download the **MyCrimp App** for more information.

Section 2
SG Fittings

FITTINGS



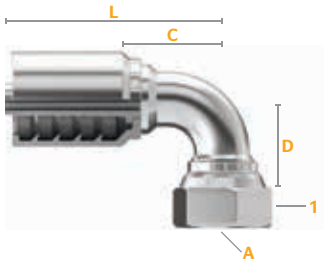

BSPP (British Standard Pipe Parallel)

Female / 90° Elbow / Swivel



Part Number	Product Number	SAP Number	Hose ID	Thread Size (A)	Hex 1 Wrench Size	Drop (D)		Cut-Off (C)		Length (L)	
			in.		mm	in.	mm	in.	mm	in.	mm
SG-BPFX90-0608	29120-0608	20822214	3/8	1/2-14	27	1.40	35.6	1.34	34.0	2.80	71.0
SG-BPFX90-0808	29120-0808	20731763	1/2	1/2-14	27	1.61	40.9	1.42	36.1	2.96	75.1
SG-BPFX90-1212 ^T	29120-1212	20822213	3/4	3/4-14	32	2.24	56.9	2.35	59.7	4.22	107.2
SG-BPFX90-1616 ^T	29120-1616	20822212	1	1-11	38	2.80	71.1	3.04	77.3	5.33	135.3
SG-BPFX90-2020	29120-2020	20926358	1 ¼	1 ¼-11	50	3.27	83.1	3.62	92.0	6.76	171.6
SG-BPFX90-2424	29120-2424	20757732	1 ½	1 ½-11	55	3.78	96.0	4.53	115.0	7.99	203.0
SG-BPFX90-3232	29120-3232	20873180	2	2-11	70	5.51	140.0	5.71	145.0	9.25	235.0

^T=Thurst Wire Nut (See Fitting Identification in Appendix for more information.)

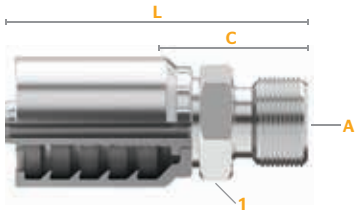

BSPP (British Standard Pipe Parallel)

Male





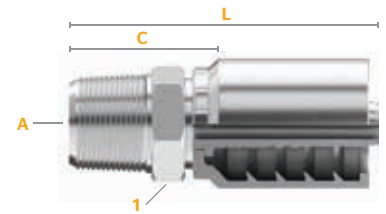

Part Number	Product Number	SAP Number	Hose ID	Thread Size (A)	Hex 1 Wrench Size	Cut-Off (C)		Length (L)	
			in.		in.	in.	mm	in.	mm
SG-BPM-0606	29130-0606	20822211	3/8	3/8-19	22	1.20	30.5	2.66	67.5
SG-BPM-0608	29130-0608	20822210	3/8	1/2-14	27	1.34	34.0	2.80	71.0
SG-BPM-0806	29130-0806	20822209	1/2	3/8-19	22	1.20	30.5	2.74	69.5
SG-BPM-0808	29130-0808	20822208	1/2	1/2-14	27	1.34	34.0	2.88	73.1
SG-BPM-1212	29130-1212	20822207	3/4	3/4-14	32	1.56	39.6	3.43	87.1
SG-BPM-1616	29130-1616	20822206	1	1-11	36	1.85	47.1	4.14	105.1
SG-BPM-2020	29130-2020	20926359	1 ¼	1 ¼-11	50	2.12	53.8	5.26	133.6
SG-BPM-2424	29130-2424	20757731	1 ½	1 ½-11	50	2.46	62.4	5.92	150.4
SG-BPM-3232	29130-3232	20833303	2	2-11	70	2.81	71.3	6.35	161.3

BSPT (British Standard Pipe Tapered)

Male





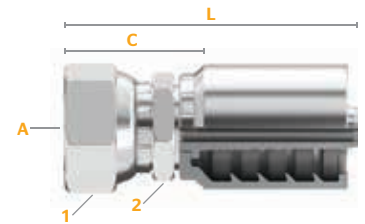

Part Number	Product Number	SAP Number							
			Hose ID	Thread Size (A)	Hex 1 Wrench Size	Cut-Off (C)	Length (L)	in.	mm
SG-BTM-0606	29170-0606	20822205	3/8	3/8-19	22	1.20	30.5	2.65	67.5
SG-BTM-0808	29170-0808	20822204	1/2	1/2-14	27	1.37	34.9	2.91	73.9
SG-BTM-1212	29170-1212	20822203	3/4	3/4-14	22	1.48	37.5	3.347	85.0
SG-BTM-1616	29170-1616	20822202	1	1-11	27	1.89	48.1	4.18	106.1
SG-BTM-3232	29170-3232	20833297	2	2-11	32	2.67	67.9	6.22	157.9

BSP Flat Seat (British Standard Pipe)

Female / Swivel





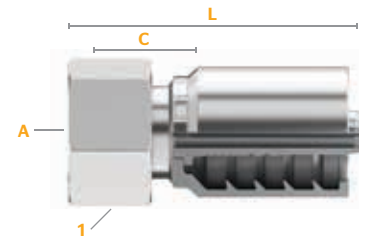

Part Number	Product Number	SAP Number							
			Hose ID	Thread Size (A)	Hex 1 Wrench Size	Cut-Off (C)	Length (L)	in.	mm
SG-BFFX-0608	29100-0608	20822227	3/8	1/2-14	27	0.80	20.3	2.26	57.3
SG-BFFX-0808	29100-0808	20822226	1/2	1/2-14	27	0.82	20.9	2.36	59.8
SG-BFFX-0812	29100-0812	20822225	1/2	3/4-14	32	1.00	25.4	2.54	64.4

DIN 24° Light

Female / Swivel



Part Number	Product Number	SAP Number							
			Hose ID	Thread Size (A)	Hex 1 Wrench Size	Cut-Off (C)	Length (L)	in.	mm
SG-DLFX-0618	29240-0618	20758288	3/8	18x1.5	22	0.91	23.1	2.60	66.0
SG-DLFX-0822	29240-0822	20758302	1/2	22x1.5	27	1.21	30.7	2.46	62.4
SG-DLFX-1230	29240-1230	20822154	3/4	30x2.0	36	1.42	36.0	3.29	83.5

Continued on the next page.



Download the **MyCrimp App** for more information.

Section 2
SG Fittings

FITTINGS



DIN 24° Light (Female) Continued

Part Number	Product Number	SAP Number	Hose ID	Thread Size (A)	Hex 1 Wrench Size	Cut-Off (C)		Length (L)	
			in.		mm	in.	mm	in.	mm
SG-DLFX-1236	29240-1236	20822153	3/4	36x2.0	41	1.60	40.7	3.47	88.2
SG-DLFX-1636	29240-1636	20822152	1	36x2.0	41	1.49	37.9	3.60	91.5
SG-DLFX-2045	29240-2045	20926475	1 ¼	45x2.0	50	1.72	43.9	4.86	123.4
SG-DLFX-2452	29240-2452	20873207	1 ½	52x2.0	60	2.07	52.8	5.54	140.7

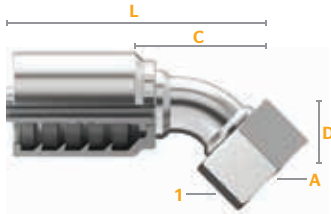

DIN 24° Light

Female / 45° Elbow / Swivel

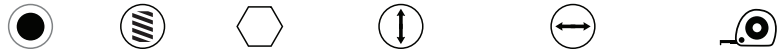

Part Number	Product Number	SAP Number	Hose ID	Thread Size (A)	Hex 1 Wrench Size	Drop (D)		Cut-Off (C)		Length (L)	
			in.		mm	in.	mm	in.	mm	in.	mm
SG-DLFX45-0822	29245-0822	20822150	1/2	22x1.5	27	0.83	21.1	2.17	55.1	3.71	94.1
SG-DLFX45-1230	29245-1230	20822149	3/4	30x2.0	36	1.26	32.0	2.72	69.1	4.59	116.6
SG-DLFX45-1636	29245-1636	20822148	1	36x2.0	41	1.26	32.0	3.58	90.9	5.86	148.9
SG-DLFX45-2452	29245-2452	20873208	1 ½	52x2.0	60	1.85	47.0	4.88	124.0	8.35	212.1

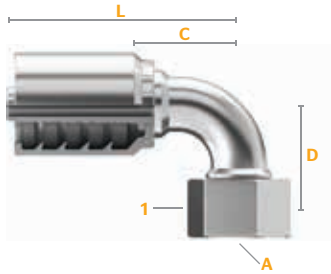

DIN 24° Light

Female / 90° Elbow / Swivel



Part Number	Product Number	SAP Number	Hose ID	Thread Size (A)	Hex 1 Wrench Size	Drop (D)		Cut-Off (C)		Length (L)	
			in.		mm	in.	mm	in.	mm	in.	mm
SG-DLFX90-0822	29250-0822	20822146	1/2	22x1.5	27	1.59	40.4	1.57	39.9	3.11	78.9
SG-DLFX90-1026	29250-1026	20923048	5/8	26x1.5	32	1.89	48.0	2.01	51.1	3.60	91.4
SG-DLFX90-1230	29250-1230	20822144	3/4	30x2.0	36	2.32	58.9	2.05	52.1	3.92	99.6
SG-DLFX90-1636	29250-1636	20822143	1	36x2.0	41	2.68	68.1	3.07	78.0	5.35	136.0

Continued on the next page.

FITTINGS



Section 2

SG Fittings

COMPATIBLE HOSE:

SR12 SR13 SR15 S4SP XCP3S XCP5S
 ARC12 ARC13 ARC15 S4SH XCP4S XCP6S

For a detailed list, please refer to your Crimp Specifications Manual.

DIN 24° Light (Female 90° Elbow) Continued

Part Number	Product Number	SAP Number	Hose ID	Thread Size (A)	Hex 1 Wrench Size	Drop (D)		Cut-Off (C)		Length (L)	
			in.		mm	in.	mm	in.	mm	in.	mm
SG-DLFX90-2045	29250-2045	20926476	1 1/4	45x2.0	50	3.50	88.9	3.62	92.0	6.76	171.7
SG-DLFX90-2452	29250-2452	20873209	1 1/2	52x2.0	60	3.84	97.5	4.53	115.0	7.99	203.0
SG-DLFX90XL-2452	29252-2452	20873210	1 1/2	52x2.0	60	8.50	215.9	4.53	115.0	7.99	203.0

DIN 24° Light

Male

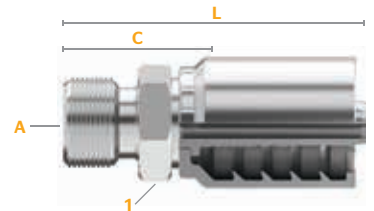

Part Number	Product Number	SAP Number	Hose ID	Thread Size (A)	Hex 1 Wrench Size	Cut-Off (C)		Length (L)	
			in.		mm	in.	mm	in.	mm
SG-DLM-0822	29255-0822	20822140	1/2	22x1.5	22	1.10	28.0	2.64	67.0
SG-DLM-1026	29255-1026	20959265	5/8	26x1.5		1.16	29.5	2.76	70.1
SG-DLM-1230	29255-1230	20822139	3/4	30x2.0	32	1.35	34.3	3.22	81.8
SG-DLM-1636	29255-1636	20822138	1	36x2.0	36	1.50	38.2	3.79	96.2

DIN 24° Heavy

Female / Swivel

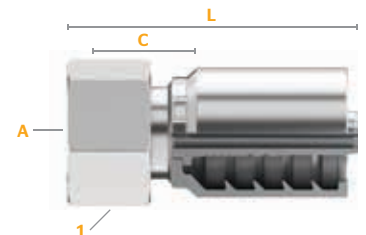

Part Number	Product Number	SAP Number	Hose ID	Thread Size (A)	Hex 1 Wrench Size	Cut-Off (C)		Length (L)	
			in.		mm	in.	mm	in.	mm
SG-DHFX-0620	29210-0620	20774066	3/8	20x1.5	24	1.21	30.8	2.67	67.8
SG-DHFX-0622	29210-0622	20822180	3/8	22x1.5	27	1.42	36.2	2.88	73.2
SG-DHFX-0624	29210-0624	20873181	3/8	24x1.5	30	1.473	37.3	2.74	69.6
SG-DHFX-0824	29210-0824	20731609	1/2	24x1.5	30	1.44	36.5	2.79	70.7
SG-DHFX-1030	29210-1030	20822179	5/8	30x2.0	36	1.64	41.7	3.23	82.1

Continued on the next page.



Download the **MyCrimp App** for more information.

Section 2
SG Fittings

FITTINGS



DIN 24° Heavy (Female) Continued

Part Number	Product Number	SAP Number	Hose ID	Thread Size (A)	Hex 1 Wrench Size	Cut-Off (C)		Length (L)	
			in.		mm	in.	mm	in.	mm
SG-DHFX-1230	29210-1230	20822178	3/4	30x2.0	36	1.60	40.7	3.33	84.5
SG-DHFX-1236	29210-1236	20774357	3/4	36x2.0	46	1.89	47.9	3.75	95.4
SG-DHFX-1236S	29210-1236S	20822177	3/4	36x2.0	46	1.89	47.9	3.75	95.4
SG-DHFX-1636	29210-1636	20822176	1	36x2.0	46	2.17	55.1	4.45	113.2
SG-DHFX-1642	29210-1642	20822175	1	42x2.0	50	1.88	47.9	4.16	105.8
SG-DHFX-2052	29210-2052	20926474	1 1/4	52x2.0	60	2.13	54.1	5.26	133.6

S=Stainless Steel (See Fitting Identification in Appendix for more information.)

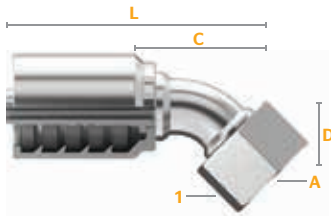

DIN 24° Heavy





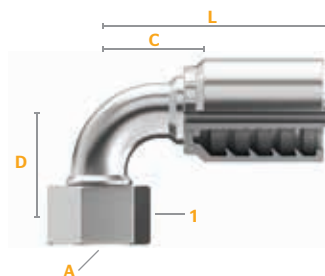

Female / 45° Elbow / Swivel

Part Number	Product Number	SAP Number	Hose ID	Thread Size (A)	Hex 1 Wrench Size	Drop (D)		Cut-Off (C)		Length (L)	
			in.		mm	in.	mm	in.	mm	in.	mm
SG-DHFX45-0620	29215-0620	20822174	3/8	20x1.5	24	0.79	20.1	2.01	51.1	3.46	88.1
SG-DHFX45-0622	29215-0622	20822173	3/8	22x1.5	27	0.83	21.1	2.09	53.1	3.54	90.1
SG-DHFX45-0624	29215-0624	20873182	3/8	24x1.5	30	0.85	21.6	2.19	55.6	3.64	92.7
SG-DHFX45-0824	29215-0824	20822172	1/2	24x1.5	30	0.85	21.6	2.20	55.9	3.73	94.9
SG-DHFX45-1030	29215-1030	20900860	5/8	30x2.0	36	1.18	30.0	2.60	66.0	4.19	106.5
SG-DHFX45-1230	29215-1230	20923060	3/4	30x2.0	36	1.17	29.7	3.33	84.6	5.20	132.1
SG-DHFX45-1236	29215-1236	20822171	3/4	36x2.0	46	1.30	33.0	2.72	69.1	4.59	116.6
SG-DHFX45-1642	29215-1642	20822170	1	42x2.0	50	1.59	40.4	4.33	110.0	6.613	168.0

DIN 24° Heavy

Female / 90° Elbow / Swivel





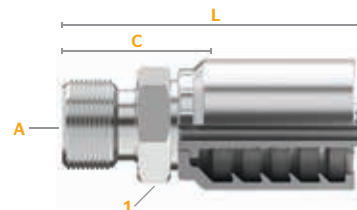

Part Number	Product Number	SAP Number									
			Hose ID	Thread Size (A)	Hex 1 Wrench Size	Drop (D)	Cut-Off (C)	Length (L)	in.	mm	in.
SG-DHFX90-0620	29220-0620	20822169	3/8	20x1.5	24	1.52	38.6	1.34	34.0	2.80	71.0
SG-DHFX90-0622	29220-0622	20822168	3/8	22x1.5	27	1.59	40.4	1.34	34.0	2.80	71.0
SG-DHFX90-0824	29220-0824	20731752	1/2	24x1.5	30	1.63	41.4	1.57	39.9	3.11	78.9
SG-DHFX90-1030	29220-1030	20822167	5/8	30x2.0	36	2.17	55.1	1.97	50.0	3.56	90.5
SG-DHFX90-1230	29220-1230	20822166	3/4	30x2.0	36	2.28	57.9	2.01	51.1	3.88	98.6
SG-DHFX90-1236	29220-1236	20822165	3/4	36x2.0	46	2.34	59.4	2.01	51.1	3.88	98.6
SG-DHFX90-1642	29220-1642	20822163	1	42x2.0	50	3.11	79.0	2.99	75.9	5.27	133.9
SG-DHFX90-2052	29220-2052	20959264	1 1/4	52x2.0	60	3.98	101.1	3.97	100.8	7.11	180.6

DIN 24° Heavy

Male



Part Number	Product Number	SAP Number							
			Hose ID	Thread Size (A)	Hex 1 Wrench Size	Cut-Off (C)	Length (L)	in.	mm
SG-DHM-0824	29225-0824	20822160	1/2	24x1.5	24	1.22	31.0	2.76	70.0
SG-DHM-1030	29225-1030	20900861	5/8	30x2.0	30	1.40	35.6	2.99	75.9
SG-DHM-1230	29225-1230	20822159	3/4	30x2.0	32	1.44	36.5	3.31	84.0
SG-DHM-1236	29225-1236	20822158	1	26x2.0	36	1.60	40.6	3.47	88.1
SG-DHM-1642	29225-1642	20822157	1	42x2.0	46	1.82	46.2	4.10	104.2



Download the **MyCrimp App** for more information.

Section 2
SG Fittings

FITTINGS



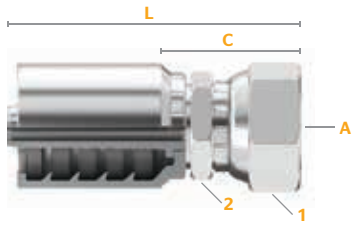

Komatsu® 30° Flare with Metric Threads

Female / Swivel

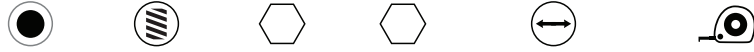

Part Number	Product Number	SAP Number	Hose ID	Thread Size (A)	Hex 1 Wrench Size	Hex 2 Wrench Size	Cut-Off (C)		Length (L)	
			in.		mm	mm	in.	mm	in.	mm
SG-KMFX-0618	29545-0618	20821982	3/8	18x1.5	22		1.36	34.6	2.82	71.6
SG-KMFX-0822	29545-0822	20758298	1/2	22x1.5	27		1.47	37.3	3.00	76.3
SG-KMFX-1024	29545-1024	20821981	5/8	24x1.5	32		1.75	44.5	3.35	85.0
SG-KMFX-1230	29545-1230	20821980	3/4	30x1.5	36		1.95	49.5	3.82	97.0
SG-KMFX-1633	29545-1633	20821979	1	33x1.5	41		2.43	61.8	4.72	119.8
SG-KMFX-2036	29545-2036	20926514	1 ¼	36x1.5	46	41	2.72	69.2	5.86	148.8
SG-KMFX-2442	29545-2442	20873196	1 ½	42x1.5	55		3.09	78.5	6.55	166.5

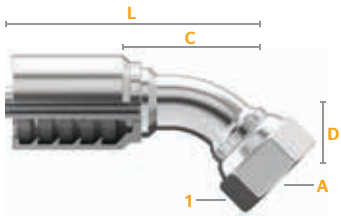

Komatsu® 30° Flare with Metric Threads

Female / 45° Elbow / Swivel







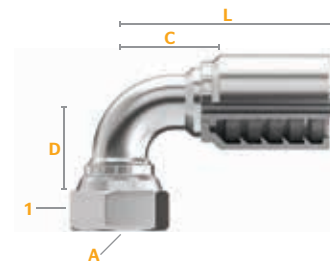

Part Number	Product Number	SAP Number	Hose ID	Thread Size (A)	Hex 1 Wrench Size	Drop (D)	Cut-Off (C)		Length (L)	
			in.		mm	in.	mm	in.	mm	in.
SG-KMFX45-0618	29548-0618	20821978	3/8	18x1.5	22	0.71	1.73	43.9	3.19	80.9
SG-KMFX45-0822	29548-0822	20821977	1/2	22x1.5	27	1.16	2.20	55.9	3.74	94.9

Komatsu® 30° Flare with Metric Threads

Female / 90° Elbow / Swivel







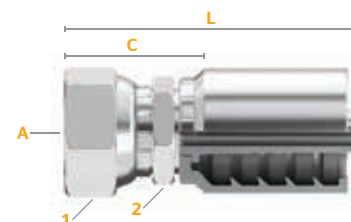

Part Number	Product Number	SAP Number									
			Hose ID	Thread Size (A)	Hex 1 Wrench Size	Drop (D)	Cut-Off (C)	Length (L)			
			in.		mm	in.	mm	in.	mm		
SG-KMFX90-0618	29550-0618	20821976	3/8	18x1.5	22	1.40	35.6	1.42	36.1	2.88	73.1
SG-KMFX90-0822	29550-0822	20821975	1/2	22x1.5	27	2.09	53.1	1.74	44.1	3.27	83.1

JIS 30° (Parallel Pipe Threads)

Female / Swivel



Part Number	Product Number	SAP Number								
			Hose ID	Thread Size (A)	Hex 1 Wrench Size	Hex 2 Wrench Size	Cut-Off (C)	Length (L)		
			in.		mm	mm	in.	mm	in.	mm
SG-JSFX-0606	29520-0606	20821992	3/8	3/8-19	22	19	1.36	34.6	2.82	71.6
SG-JSFX-0808	29520-0808	20821991	1/2	1/2-14	27	22	1.47	37.2	3.00	76.3
SG-JSFX-1212	29520-1212	20821990	3/4	3/4-14	36	30	1.70	43.1	3.57	90.6
SG-JSFX-1616	29520-1616	20821989	1	1-11	41	36	2.05	52.1	4.33	110.1
SG-JSFX-2020	29520-2020	20926513	1 1/4	1 1/4-11	50	41	2.35	59.7	5.48	139.2



Download the **MyCrimp App** for more information.

Section 2
SG Fittings

FITTINGS



SECTION 3 - S6 AND DG FITTINGS

This section lists all fittings compatible with the following hose:

Hose	Description	Compatible Dash Size	Hose	Description	Compatible Dash Size
SR13	SAE 100R13 / EN 856 R13	Hose dash sizes -24 and -32	ARC15	SAE 100R15	All hose dash sizes
ARC13	SAE 100R13	All hose dash sizes	S4SP	EN 856 4SP / DIN 20023 4SP	All hose dash sizes
SR15	SAE 100R15	All hose dash sizes	S4SH	EN 856 4SH / DIN 20023 4SH	All hose dash sizes

How to Use the Fittings Table





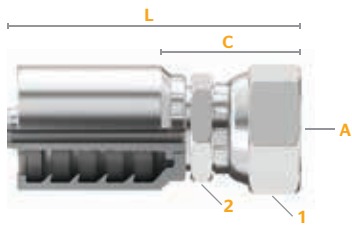

The fittings in this section will follow a similar table structure to the one seen on this page.

Fitting dimensions and attributes are explained below.



Fitting Name

Fitting Description

Part Number	Product Number	SAP Number											
			Hose ID	Thread Size (A)	Hex 1 Wrench Size	Hex 2 Wrench Size	Cut-Off (C)	Length (L)	Skive Type*				
			in.		in.	mm	in.	mm	in.	mm			
S6-JCFX-2424	30400-2424	20241922	1 1/2	1 7/8 -12	2 3/8	55	2	50	1.94	49.4	5.94	151.0	NS
S6-JCFX-3232	30400-3232	20242040	2	2 1/2 -12	2 13/16	70	2 13/16	70	2.58	65.5	6.51	165.4	NS

*NS=Non-Skive

Fitting Dimensions and Attributes

Part Number See Hydraulic Fittings Nomenclature on page 128 for a breakdown of part number attributes

Hose ID The compatible Hose ID

Tube ID The compatible Tube ID

Thread Size The thread size or sizes available for a particular fitting dash size (indicated by **A** in the fitting image)

Hex Size The wrench size for one or both nuts on the fitting (indicated by **1** or **2** in the fitting image)

Drop The length of the elbow (indicated by **D** in the fitting image)

Cut-Off The amount of hose to be cut for a correct assembly length (indicated by **C** in the fitting image)

Length The overall length of the fitting

Skive Type For applicable fittings, a skive type will be indicated as Skive, Non-Skive or Dual-Grip

Choose fittings carefully, considering the working pressure of both the hose and fitting. The maximum working pressure of the hose assembly is the lesser of the rated working pressure of the hose and the fitting. See page 389 for the Fittings Working Pressure Guide.

FITTINGS



Section 3

S6 + DG Fittings





























COMPATIBLE HOSE:

SR13 SR15 S4SP
ARC13 ARC15 S4SH

For a detailed list, please refer to your Crimp Specifications Manual.

S6 and DG Fittings Overview

A complete overview of all S6 and DG fittings found in this section.

<p>JIC 37° Flare (SAE J514) Uni-Crimp™ & Dual-Grip Female Swivel</p>  <p>S6-JCFX P. 219</p>	<p>JIC 37° Flare (SAE J514) Female 45° Elbow Swivel</p>  <p>S6-JCFX45 P. 219</p>	<p>JIC 37° Flare (SAE J514) Uni-Crimp™ & Dual-Grip Female Swivel</p>  <p>S6-JCFX90 P. 220</p>	<p>JIC 37° Flare (SAE J514) Uni-Crimp™ & Dual-Grip Male</p>  <p>S6-JCM P. 220</p>
<p>NPTF Uni-Crimp™ & Dual-Grip Male</p>  <p>S6-NPM P. 221</p>	<p>NPM API Uni-Crimp™ & Dual-Grip Male</p>  <p>S6-NPMAPI P. 221</p>	<p>O-Ring Face Seal Uni-Crimp™ & Dual-Grip Female Swivel</p>  <p>S6-OFFX P. 222</p>	<p>O-Ring Face Seal Female 45° Elbow Swivel</p>  <p>S6-OFFX45 P. 222</p>
<p>O-Ring Face Seal Uni-Crimp™ & Dual-Grip Female 90° Elbow Swivel</p>  <p>S6-OFFX90 P. 223</p>	<p>O-Ring Face Seal Male</p>  <p>S6-OFM P. 223</p>	<p>Code 61 Flange Uni-Crimp™ & Dual-Grip</p>  <p>S6-FL P. 224</p>	<p>Code 61 Flange 22.5° Elbow</p>  <p>S6-FL22 P. 224</p>
<p>Code 61 Flange (SAE J518) Uni-Crimp™ & Dual-Grip 30° Elbow</p>  <p>S6-FL30 P. 225</p>	<p>Code 61 Flange (SAE J518) Uni-Crimp™ & Dual-Grip 45° Elbow</p>  <p>S6-FL45 P. 225</p>	<p>Code 61 Flange (SAE J518) 60° Elbow</p>  <p>S6-FL60 P. 226</p>	<p>Code 61 Flange (SAE J518) 67° Elbow</p>  <p>S6-FL67 P. 226</p>
<p>Code 61 Flange (SAE J518) Uni-Crimp™ & Dual-Grip 90° Elbow</p>  <p>S6-FL90 P. 227</p>	<p>Code 62 Flange (SAE J518) Uni-Crimp™ & Dual-Grip</p>  <p>S6-FH P. 227</p>	<p>Code 62 Flange (SAE J518) 22.5° Elbow</p>  <p>S6-FH22 P. 228</p>	<p>Code 62 Flange (SAE J518) 30° Elbow</p>  <p>S6-FH30 P. 228</p>
<p>Code 62 Flange (SAE J518) Uni-Crimp™ & Dual-Grip 45° Elbow</p>  <p>S6-FH45 P. 229</p>	<p>Code 62 Flange (SAE J518) 60° Elbow</p>  <p>S6-FH60 P. 229</p>	<p>Code 62 Flange (SAE J518) Uni-Crimp™ & Dual-Grip 90° Elbow</p>  <p>S6-FH90 P. 230</p>	<p>Caterpillar® Flange</p>  <p>S6-CF P. 230</p>
<p>Caterpillar® Flange 22.5° Elbow</p>  <p>S6-CF22 P. 231</p>	<p>Caterpillar® Flange 30° Elbow</p>  <p>S6-CF30 P. 231</p>	<p>Caterpillar® Flange 45° Elbow</p>  <p>S6-CF45 P. 231</p>	<p>Caterpillar® Flange 60° Elbow</p>  <p>S6-CF60 P. 232</p>



Download the **MyCrimp App** for more information.

Section 3
S6 + DG Fittings

FITTINGS



S6 and DG Fittings Overview

A complete overview of all S6 and DG fittings found in this section.

<p>Caterpillar® Flange 90° Elbow</p>  <p>S6-CF90 P. 232</p>	<p>IHUF Hammer Union</p>  <p>S6-IHUF P. 233</p>	<p>IHUM Hammer Union</p>  <p>S6-IHUM P. 233</p>	<p>British Standard Pipe Parallel Uni-Crimp™ & Dual-Grip Female Swivel</p>  <p>S6-BPFX P. 233</p>
<p>British Standard Pipe Parallel Uni-Crimp™ & Dual-Grip Female 45° Elbow Swivel</p>  <p>S6-BPFX45 P. 234</p>	<p>British Standard Pipe Parallel Uni-Crimp™ & Dual-Grip Female 90° Elbow Swivel</p>  <p>S6-BPFX90 P. 234</p>	<p>British Standard Pipe Parallel Male</p>  <p>S6-BPM P. 235</p>	<p>British Standard Pipe Tapered Male</p>  <p>S6-BTM P. 235</p>

JIC 37° Flare (SAE J514)

Female / Swivel

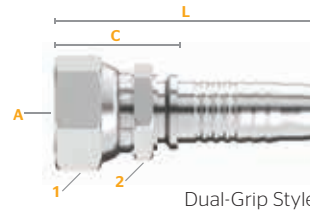



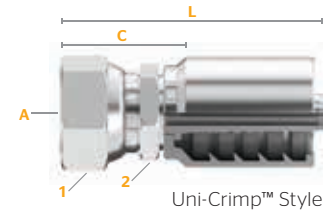



Dual-Grip Style



Uni-Crimp™ Style

Uni-Crimp™ Style

Part Number	Product Number	SAP Number											
			Hose ID	Thread Size (A)	Hex 1 Wrench Size	Hex 2 Wrench Size	Cut-Off (C)	Length (L)	Skive Type*				
S6-JCFX-2424	30400-2424	20241922	in.		in.	mm	in.	mm	in.	mm	in.	mm	NS
S6-JCFX-3232	30400-3232	20242040	2	1 1/2 -12	2 3/16	55	2	50	1.94	49.4	5.94	151.0	NS
S6-JCFX-3232	30400-3232	20242040	2	2 1/2 -12	2 1/16	70	2 13/16	70	2.58	65.5	6.51	165.4	NS

*NS=Non-Skive

Dual-Grip Style





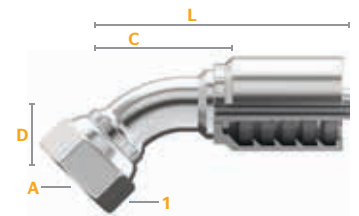

Part Number	Product Number	SAP Number	Hose ID	Thread Size (A)	Hex 1 Wrench Size		Hex 2 Wrench Size		Cut-Off (C)		Length (L)		Skive Type*
					in.	mm	in.	mm	in.	mm	in.	mm	
DG-JCFX-2424 ^{T1}	16400-2424	20242432	1 1/2	1 1/2 -12	2 3/16	55			1.14	29.0	5.47	139.0	DG
DG-JCFX-3232 ^{T1}	16400-3232	20254272	2	2 1/2 -12	2 13/16	70			1.34	34.0	6.10	155.0	DG

T=Thrust-Wire Nut 1=Single Hex (See Fitting Identification in Appendix for more information) *DG=Dual-Grip

JIC 37° Flare (SAE J514)

Female / 45° Elbow / Swivel



Part Number	Product Number	SAP Number										Skive Type*	
			Hose ID	Thread Size (A)	Hex 1 Wrench Size	Drop (D)	Cut-Off (C)	Length (L)					
S6-JCFX45-2424	30420-2424	20424976	in.		in.	mm	in.	mm	in.	mm	in.	mm	NS
S6-JCFX45-2424	30420-2424	20424976	1 1/2	1 1/2 -12	2 3/16	55	1.71	43.5	4.65	118.0	8.64	219.5	NS
S6-JCFX45-3232	30420-3232	20788106	2	2 1/2 -12	2 1/16	70	2.76	70.1	6.54	166.1	10.47	266.7	NS

*NS=Non-Skive

 Download the **MyCrimp App** for more information.

Section 3
S6 + DG Fittings

FITTINGS



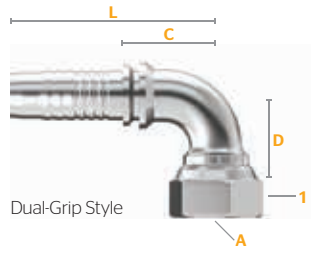

JIC 37° Flare (SAE J514)

Female / 90° Elbow / Swivel

Uni-Crimp™ Style

Part Number	Product Number	SAP Number	Hose ID	Thread Size (A)	Hex 1 Wrench Size		Drop (D)		Cut-Off (C)		Length (L)		Skive Type*
					in.	mm	in.	mm	in.	mm	in.	mm	
S6-JCFX90-2424	30425-2424	20241905	1 ½	1 ¾-12	2 ⅝	55	3.62	92.0	4.13	105.0	7.40	188.0	NS
S6-JCFX90-3232	30425-3232	20788107	2	2 ½-12	2 ⅞	70	5.51	140.2	5.71	145.0	9.64	244.9	NS

*NS=Non-Skive

Dual-Grip Style

Part Number	Product Number	SAP Number	Hose ID	Thread Size (A)	Hex 1 Wrench Size		Drop (D)		Cut-Off (C)		Length (L)		Skive Type*
					in.	mm	in.	mm	in.	mm	in.	mm	
DG-JCFX90-2424 ^T	16425-2424	20254277	1 ½	1 ¾-12	2 ⅝	55	3.62	92.0	3.70	94.0	7.28	185.0	DG

^T=Thrust-Wire Nut (See Fitting Identification in Appendix for more information.) *DG=Dual-Grip

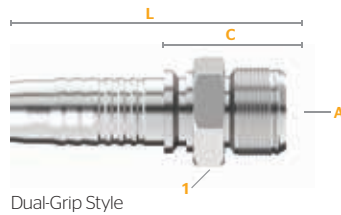
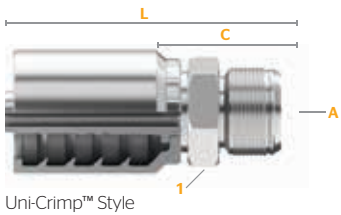

JIC 37° Flare (SAE J514)

Male

Uni-Crimp™ Style

Part Number	Product Number	SAP Number	Hose ID	Thread Size (A)	Hex 1 Wrench Size		Cut-Off (C)		Length (L)		Skive Type*
					in.	mm	in.	mm	in.	mm	
S6-JCM-2424	30450-2424	20424981	1 ½	1 ¾-12	2	50	2.26	57.5	5.53	140.5	NS
S6-JCM-3232	30450-3232	20788108	2	2 ½-12	2 ⅞	70	2.83	71.8	6.76	171.6	NS

*NS=Non-Skive

Dual-Grip Style

Part Number	Product Number	SAP Number	Hose ID	Thread Size (A)	Hex 1 Wrench Size		Cut-Off (C)		Length (L)		Skive Type*
					in.	mm	in.	mm	in.	mm	
DG-JCM-2424	16450-2424	20242352	1 ½	1 ¾-12	2	50	1.54	39.0	5.57	141.5	DG

*DG=Dual-Grip

FITTINGS



Section 3

S6 + DG Fittings

COMPATIBLE HOSE:

SR13 SR15 S4SP
 ARC13 ARC15 S4SH

For a detailed list, please refer to your Crimp Specifications Manual.

NPTF

Male

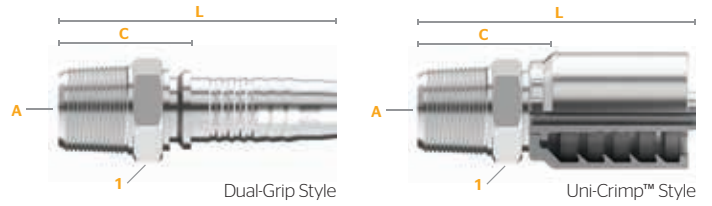

Uni-Crimp™ Style

Part Number	Product Number	SAP Number	Hose ID	Thread Size (A)	Hex 1 Wrench Size		Cut-Off (C)		Length (L)		Skive Type*
					in.	mm	in.	mm	in.	mm	
S6-NPM-2424	30615-2424	20293313	1 ½	1 ½ - 1 1/2	2	50	2.19	55.5	5.45	138.5	NS
S6-NPM-2432	30615-2432	20864301	1 ½	2 - 1 1/2							NS
S6-NPM-3232	30615-3232	20293314	2	2 - 1 1/2	2 5/16	70	2.53	64.1	6.45	163.9	NS

*NS=Non-Skive

Dual-Grip Style

Part Number	Product Number	SAP Number	Hose ID	Thread Size (A)	Hex 1 Wrench Size		Cut-Off (C)		Length (L)		Skive Type*
					in.	mm	in.	mm	in.	mm	
DG-NPM-1616	16615-1616	20242518	1	1 - 1 1/2	1 7/16	36	1.34	34.0	4.67	118.5	DG
DG-NPM-2020	16615-2020	20242437	1 ¼	1 ¼ - 1 1/2	1 3/16	46	1.41	35.8	5.24	133.0	DG
DG-NPM-2424	16615-2424	20242354	1 ½	1 ½ - 1 1/2	2	50	1.56	39.5	5.49	139.5	DG
DG-NPM-3232	16615-3232	20242401	2	2 - 1 1/2	2 5/16	65	1.54	39.2	5.91	150.2	DG

*DG=Dual-Grip

NPM API

Male

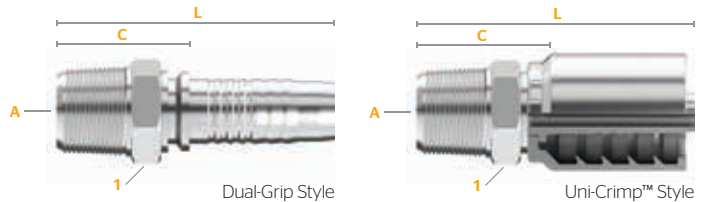

Uni-Crimp™ Style

Part Number	Product Number	SAP Number	Hose ID	Thread Size (A)	Hex 1 Wrench Size		Cut-Off (C)		Length (L)		Skive Type*
					in.	mm	in.	mm	in.	mm	
S6-NPM-API-2424	30617-2424	20466174	1 ½	1 ½ - 1 1/2	2	50	3.27	83.0	6.54	166.0	NS
S6-NPM-API-3232	30618-3232	20679658	2	2 - 1 1/2	2 5/16	70	4.20	106.8	8.13	206.6	NS

*NS=Non-Skive

Dual-Grip Style

Part Number	Product Number	SAP Number	Hose ID	Thread Size (A)	Hex 1 Wrench Size		Cut-Off (C)		Length (L)		Skive Type*
					in.	mm	in.	mm	in.	mm	
DG-NPM-API-3232	16630-3232	20466175	2	2 - 1 1/2	2 5/16	65	3.76	95.5	7.58	192.5	DG

*DG=Dual-Grip



Download the **MyCrimp App** for more information.

Section 3

S6 + DG Fittings

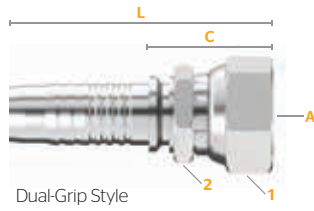
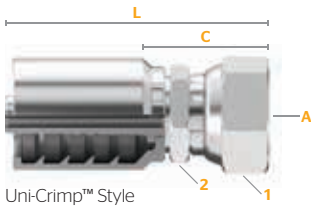

O-Ring Face Seal (SAE J1453 ORS/ORFS)

Female / Swivel

Uni-Crimp™ Style

Part Number	Product Number	SAP Number	Hose ID	Thread Size (A)	Hex 1 Wrench Size		Hex 2 Wrench Size		Cut-Off (C)		Length (L)		Skive Type*
					in.	mm	in.	mm	in.	mm	in.	mm	
S6-OFFX-2424	30700-2424	20297684	1 ½	2-12	2 ¾	60	2	50	2.46	62.5	6.36	161.5	NS

*NS=Non-Skive

Dual-Grip Style

Part Number	Product Number	SAP Number	Hose ID	Thread Size (A)	Hex 1 Wrench Size		Hex 2 Wrench Size		Cut-Off (C)		Length (L)		Skive Type*
					in.	mm	in.	mm	in.	mm	in.	mm	
DG-OFFX-2424	16700-2424	20297682	1 ½	2-12	2 ¾	60	2	50	2.05	52.0	6.28	159.5	DG

*DG=Dual-Grip

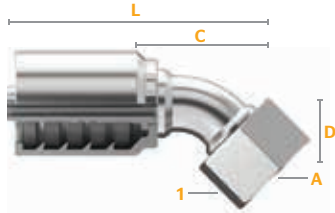

O-Ring Face Seal (SAE J1453 ORS/ORFS)

Female / 45° Elbow / Swivel

Part Number	Product Number	SAP Number	Hose ID	Thread Size (A)	Hex 1 Wrench Size		Drop (D)	Cut-Off (C)		Length (L)		
					in.	mm		in.	mm	in.	mm	
S6-OFFX45-2424	30710-2424	20424986	1 ½	2-12	2 ¾	60	1.46	37.0	4.57	116.0	8.15	207.0

O-Ring Face Seal (SAE J1453 ORS/ORFS)

Female / 90° Elbow / Swivel

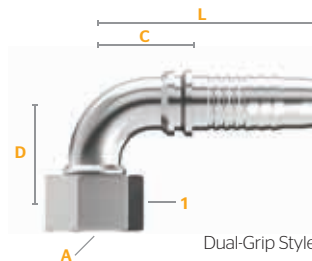

Dual-Grip Style

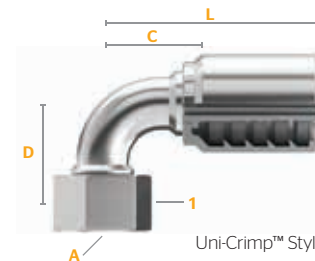

Uni-Crimp™ Style

Uni-Crimp™ Style

Part Number	Product Number	SAP Number										Skive Type*	
			Hose ID	Thread Size (A)	Hex 1 Wrench Size	Drop (D)	Cut-Off (C)	Length (L)					
			in.	in.	mm	in.	mm	in.	mm	in.	mm		
S6-OFFX90-2424	30715-2424	20297685	1 ½	2-12	2 3/8	60	3.80	96.5	5.12	130.0	8.39	213.0	NS

*NS=Non-Skive

Dual-Grip Style

Part Number	Product Number	SAP Number	Hose ID	Thread Size (A)	Hex 1 Wrench Size	Drop (D)		Cut-Off (C)		Length (L)		Skive Type*	
						in.	mm	in.	mm	in.	mm		
DG-OFFX90-2424 ^c	16715-2024	20297683	1 ½	2-12	2 ¾	60	3.31	84.0	3.90	99.0	7.52	191.0	DG

C=Crimp Nut (See Fitting Identification in Appendix for more information.) *DG=Dual-Grip

O-Ring Face Seal (SAE J1453 ORS/ORFS)

Male

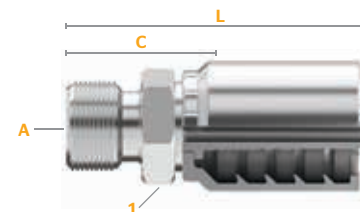

Part Number	Product Number	SAP Number								
			Hose ID	Thread Size (A)	Hex 1 Wrench Size	Cut-Off (C)	Length (L)			
			in.	in.	mm	in.	mm	in.	mm	
S6-OFM-2424	30730-2424	20424993	1 ½	2-12	2 ¾	55	1.91	48.5	5.18	131.5

Download the **MyCrimp App** for more information.

Section 3
S6 + DG Fittings

FITTINGS



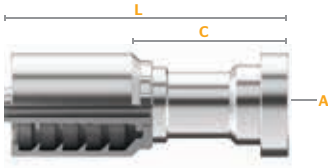



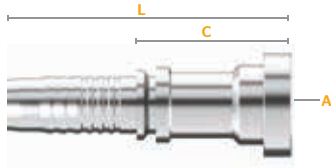

Uni-Crimp™ Style



Dual-Grip Style



Code 61 Flange (SAE J518)

Uni-Crimp™ Style

Part Number	Product Number	SAP Number									Skive Type*
			Hose ID	Flange Size	Flange Diameter (A)		Cut-Off (C)		Length (L)		
			in.		in.	mm	in.	mm	in.	mm	
S6-FL-2424	30320-2424	20307984	1 ½	1 ½	2.37	60.3	2.50	63.5	5.77	146.5	NS
S6-FL-3224	30320-3224	20788102	2	1 ½	2.37	60.3	2.99	76.0	6.92	175.8	NS
S6-FL-3232	30320-3232	20307985	2	2	2.81	71.4	2.76	70.1	6.69	169.9	NS
S6-FL-3240	30320-3240	20788103	2	2 ½	3.31	84.1	2.61	66.3	6.54	166.1	NS

*NS=Non-Skive

Dual-Grip Style





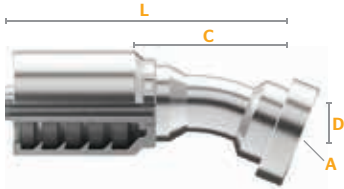

Part Number	Product Number	SAP Number	Hose ID	Flange Size							Skive Type*
					Flange Diameter (A)		Cut-Off (C)		Length (L)		
			in.		in.	mm	in.	mm	in.	mm	
DG-FL-2424	16320-2424	20242554	1 ½	1 ½	2.37	60.3	1.77	45.0	5.81	147.5	DG
DG-FL-2432	16320-2432	20242298	1 ½	2	2.81	71.4	2.22	56.5	6.26	159.0	DG
DG-FL-3232	16320-3232	20242526	2	2	2.81	71.4	2.17	55.0	6.54	166.0	DG

*DG=Dual-Grip



Code 61 Flange (SAE J518)

22.5° Elbow

Part Number	Product Number	SAP Number											Skive Type*
			Hose ID	Flange Size	Flange Diameter (A)		Drop (D)		Cut-Off (C)		Length (L)		
			in.		in.	mm	in.	mm	in.	mm	in.	mm	
S6-FL22-3232	30330-3232	20788100	2	2	2.81	71.4	0.866	22.0	5.709	145.0	9.637	244.8	NS

*NS=Non-Skive

Code 61 Flange (SAE J518)

30° Elbow

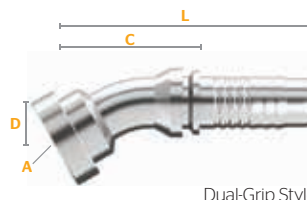

Dual-Grip Style

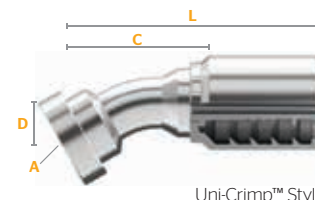

Uni-Crimp™ Style

Uni-Crimp™ Style

Part Number	Product Number	SAP Number	Hose ID		Flange Size		Flange Diameter (A)		Drop (D)		Cut-Off (C)		Length (L)		Skive Type*
			in.	mm	in.	mm	in.	mm	in.	mm	in.	mm			
S6-FL30-3232	30335-3232	20788101	2		2		2.81	71.4	1.26	32.0	5.709	145.0	9.637	244.8	NS

*NS=Non-Skive

Dual-Grip Style

Part Number	Product Number	SAP Number	Hose ID		Flange Size		Flange Diameter (A)		Drop (D)		Cut-Off (C)		Length (L)		Skive Type*
			in.	mm	in.	mm	in.	mm	in.	mm	in.	mm			
DG-FL30-3232	16335-3232	20297539	2		2		2.81	71.4	1.28	32.5	5.87	149.0	9.69	246.0	DG

*DG=Dual-Grip

Code 61 Flange (SAE J518)

45° Elbow

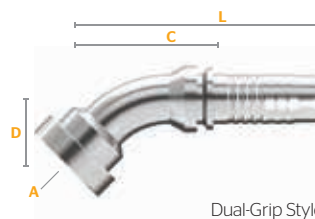

Dual-Grip Style

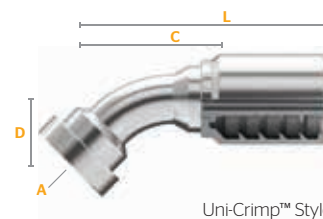

Uni-Crimp™ Style

Uni-Crimp™ Style

Part Number	Product Number	SAP Number	Hose ID		Flange Size		Flange Diameter (A)		Drop (D)		Cut-Off (C)		Length (L)		Skive Type*
			in.	mm	in.	mm	in.	mm	in.	mm	in.	mm			
S6-FL45-2424	30340-2424	20307988	1 ½		1 ½		2.37	60.3	1.69	43.0	4.37	111.0	7.64	194.0	NS
S6-FL45-3232	30340-3232	20788104	2		2		2.81	71.4	2.21	56.0	6.10	155.0	10.03	254.8	NS

*NS=Non-Skive

Dual-Grip Style

Part Number	Product Number	SAP Number	Hose ID		Flange Size		Flange Diameter (A)		Drop (D)		Cut-Off (C)		Length (L)		Skive Type*
			in.	mm	in.	mm	in.	mm	in.	mm	in.	mm			
DG-FL45-2424	16340-2424	20242449	1 ½		1 ½		2.37	60.3	1.69	43.0	4.09	104.0	7.68	195.0	DG
DG-FL45-3232	16340-3232	20242294	2		2		2.81	71.4	2.13	54.0	5.43	138.0	9.25	235.0	DG

*DG=Dual-Grip



Download the **MyCrimp App** for more information.

Section 3
S6 + DG Fittings





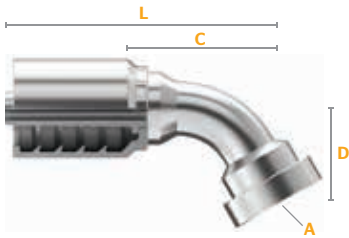

FITTINGS





Code 61 Flange (SAE J518)

60° Elbow





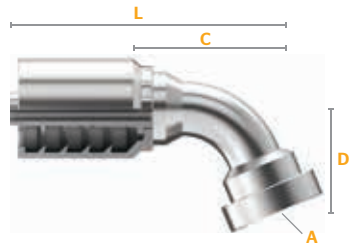

Part Number	Product Number	SAP Number											Skive Type*
			Hose ID	Flange Size	Flange Diameter (A)		Drop (D)		Cut-Off (C)		Length (L)		
			in.		in.	mm	in.	mm	in.	mm	in.	mm	
S6-FL60-3232	30345-3232	20788105	2	2	2.81	71.4	3.268	83.0	5.709	145.0	9.637	244.8	NS

*NS=Non-Skive



Code 61 Flange (SAE J518)

67° Elbow

Part Number	Product Number	SAP Number											Skive Type*
			Hose ID	Flange Size	Flange Diameter (A)		Drop (D)		Cut-Off (C)		Length (L)		
			in.		in.	mm	in.	mm	in.	mm	in.	mm	
S6-FL67-3232	30347-3232	20293322	2	2	2.81	71.4	3.819	97.0	6.30	160.0	10.23	259.8	NS

*NS=Non-Skive

FITTINGS



Section 3

S6 + DG Fittings

COMPATIBLE HOSE:

SR13	SR15	S4SP
ARC13	ARC15	S4SH

For a detailed list, please refer to your Crimp Specifications Manual.

Code 61 Flange (SAE J518)

90° Elbow

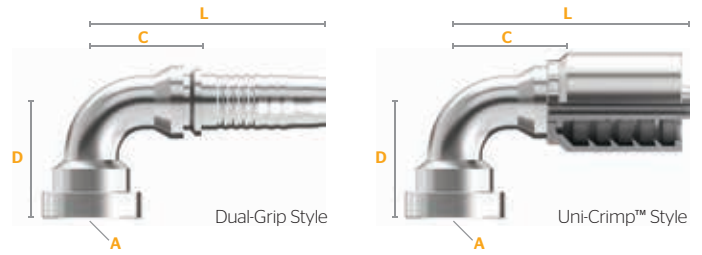

Uni-Crimp™ Style

Part Number	Product Number	SAP Number	Hose ID		Flange Size		Flange Diameter (A)		Drop (D)		Cut-Off (C)		Length (L)		Skive Type*
			in.	mm	in.	mm	in.	mm	in.	mm	in.	mm			
S6-FL90-2424	30350-2424	20308022	1 ½	40.0	1 ½	40.0	2.37	60.3	3.66	93.0	4.06	103.0	7.32	186.0	NS
S6-FL90-3232	30350-3232	20308023	2	51.0	2	51.0	2.81	71.4	5.433	138.0	5.71	145.0	9.639	168.6	NS

*NS=Non-Skive

Dual-Grip Style

Part Number	Product Number	SAP Number	Hose ID		Flange Size		Flange Diameter (A)		Drop (D)		Cut-Off (C)		Length (L)		Skive Type*
			in.	mm	in.	mm	in.	mm	in.	mm	in.	mm			
DG-FL90-2424	16350-2424	20242524	1 ½	40.0	1 ½	40.0	2.37	60.3	3.66	93.0	3.78	96.0	7.36	187.0	DG
DG-FL90-3232	16350-3232	20242525	2	51.0	2	51.0	2.81	71.4	5.12	130.0	5.28	134.0	9.09	231.0	DG

*DG=Dual-Grip

Code 62 Flange (SAE J518)

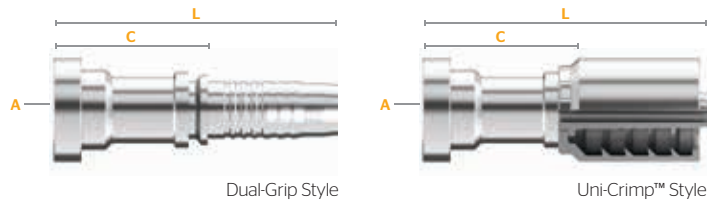

Uni-Crimp™ Style

Part Number	Product Number	SAP Number	Hose ID		Flange Size		Flange Diameter (A)		Cut-Off (C)		Length (L)		Skive Type*
			in.	mm	in.	mm	in.	mm	in.	mm			
S6-FH-2424	30300-2424	20241758	1 ½	40.0	1 ½	40.0	2.50	63.5	2.99	76.0	6.26	159.0	NS
S6-FH-2432	30300-2432	20241756	1 ½	40.0	2	51.0	3.13	79.4	3.46	88.0	6.73	171.0	NS
S6-FH-3224	30300-3224	20788098	2	51.0	1 ½	40.0	2.50	63.5	2.99	76.0	6.92	175.8	NS
S6-FH-3232	30300-3232	20241748	2	51.0	2	51.0	3.13	79.4	2.87	73.0	7.24	184.0	DG

*NS=Non-Skive DG=Dual-Grip

Dual-Grip Style

Part Number	Product Number	SAP Number	Hose ID		Flange Size		Flange Diameter (A)		Cut-Off (C)		Length (L)		Skive Type*
			in.	mm	in.	mm	in.	mm	in.	mm			
DG-FH-2424	16300-2424	20242308	1 ½	40.0	1 ½	40.0	2.50	63.5	2.26	57.5	6.30	160.0	DG
DG-FH-2432	16300-2432	20242796	1 ½	40.0	2	51.0	3.13	79.4	2.74	69.5	6.77	172.0	DG
DG-FH-3232	16300-3232	20254307	2	51.0	2	51.0	3.13	79.4	2.87	73.0	7.24	184.0	DG

*DG=Dual-Grip



Download the **MyCrimp App** for more information.

Section 3
S6 + DG Fittings





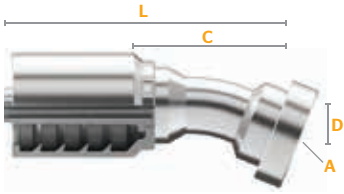

FITTINGS





Code 62 Flange (SAE J518)

22.5° Elbow





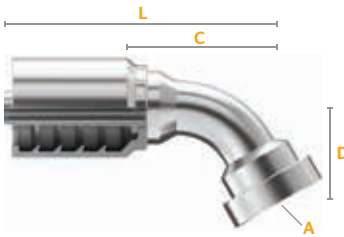

Part Number	Product Number	SAP Number											Skive Type*
			Hose ID	Flange Size	Flange Diameter (A)		Drop (D)		Cut-Off (C)		Length (L)		
			in.		in.	mm	in.	mm	in.	mm	in.	mm	
S6-FH22-3232	30303-3232	20788097	2	2	3.13	79.4	0.98	25.0	5.71	145.0	9.39	238.4	NS

*NS=Non-Skive



Code 62 Flange (SAE J518)

30° Elbow

Part Number	Product Number	SAP Number											Skive Type*
			Hose ID	Flange Size	Flange Diameter (A)		Drop (D)		Cut-Off (C)		Length (L)		
			in.		in.	mm	in.	mm	in.	mm	in.	mm	
S6-FH30-2424	30305-2424	20293334	1 ½	1 ½	2.50	63.5	1.16	29.5	6.06	154.0	9.33	237.0	NS
S6-FH30-3232	30305-3232	20293335	2	2	3.13	79.4	1.32	33.5	5.71	145.0	9.36	237.6	NS

*NS=Non-Skive

Code 62 Flange (SAE J518)

45° Elbow

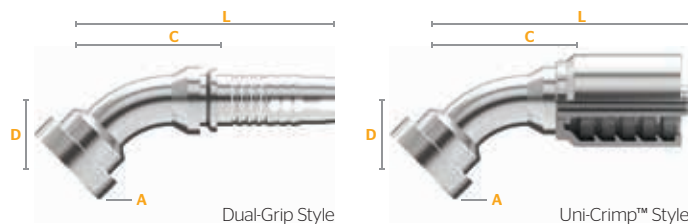

Uni-Crimp™ Style

Part Number	Product Number	SAP Number	Hose ID		Flange Size		Flange Diameter (A)		Drop (D)		Cut-Off (C)		Length (L)		Skive Type*
			in.	mm	in.	mm	in.	mm	in.	mm	in.	mm			
S6-FH45-2424	30310-2424	20241768	1 ½	38.1	1 ½	38.1	2.50	63.5	1.89	48.0	5.67	144.0	8.94	227.0	NS
S6-FH45-2432	30310-2432	20241766	1 ½	38.1	2	50.8	3.13	79.4	2.17	55.0	5.39	137.0	8.66	220.0	NS
S6-FH45-3232	30310-3232	20241779	2	50.8	2	50.8	3.13	79.4	2.21	56.0	6.10	155.0	10.03	254.8	NS

*NS=Non-Skive

Dual-Grip Style

Part Number	Product Number	SAP Number	Hose ID		Flange Size		Flange Diameter (A)		Drop (D)		Cut-Off (C)		Length (L)		Skive Type*
			in.	mm	in.	mm	in.	mm	in.	mm	in.	mm			
DG-FH45-2424	16310-2424	20242302	1 ½	38.1	1 ½	38.1	2.50	63.5	1.89	48.0	5.35	136.0	8.98	228.0	DG
DG-FH45-2432	16310-2432	20242795	1 ½	38.1	2	50.8	3.13	79.4	2.17	55.0	5.08	129.0	8.70	221.0	DG
DG-FH45-3232	16310-3232	20254310	2	50.8	2	50.8	3.13	79.4	2.48	63.0	6.34	161.0	10.16	258.0	DG

*DG=Dual-Grip

Code 62 Flange (SAE J518)

60° Elbow

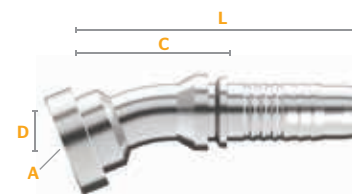

Part Number	Product Number	SAP Number	Hose ID		Flange Size		Flange Diameter (A)		Drop (D)		Cut-Off (C)		Length (L)		Skive Type*
			in.	mm	in.	mm	in.	mm	in.	mm	in.	mm			
S6-FH60-3232	30312-3232	20788099	2	50.8	2	50.8	3.13	79.4	3.27	83.0	5.71	145.0	9.64	244.8	NS

*NS=Non-Skive



Download the **MyCrimp App** for more information.

Section 3
S6 + DG Fittings

FITTINGS



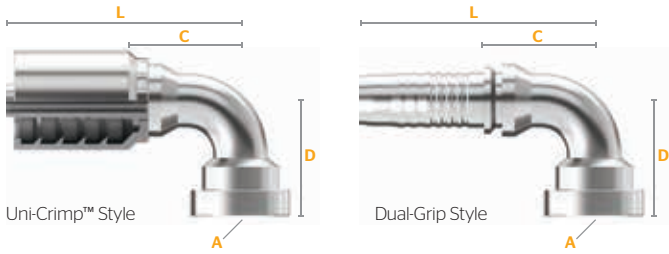







Code 62 Flange (SAE J518)

90° Elbow

Uni-Crimp™ Style

Part Number	Product Number	SAP Number											Skive Type*
			Hose ID	Flange Size	Flange Diameter (A)		Drop (D)		Cut-Off (C)		Length (L)		
			in.		in.	mm	in.	mm	in.	mm	in.	mm	
S6-FH90-2420	30315-2420	20241782	1 ½	1 ¼	2.13	54.0	3.35	85.0	4.41	112.0	7.68	195.0	NS
S6-FH90-2424	30315-2424	20241783	1 ½	1 ½	2.50	63.5	4.29	109.0	4.49	114.0	7.76	197.0	NS
S6-FH90-2432	30315-2432	20293343	1 ½	2	3.13	79.4	4.78	121.5	4.65	118.0	7.91	201.0	NS
S6-FH90-3232	30315-3232	20241735	2	2	3.13	79.4	3.27	83.0	5.71	145.0	9.64	244.8	NS

*NS=Non-Skive



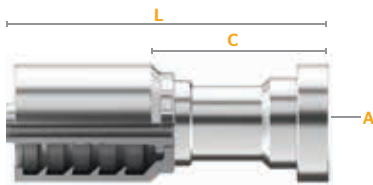

Dual-Grip Style

Part Number	Product Number	SAP Number	Hose ID	Flange Size	Flange Diameter (A)		Drop (D)		Cut-Off (C)		Length (L)		Skive Type*
			in.		in.	mm	in.	mm	in.	mm	in.	mm	
DG-FH90-2424	16315-2424	20242304	1 ½	1 ½	2.50	63.5	4.29	109.0	4.17	106.0	7.80	198.0	DG
DG-FH90-3232	16315-3232	20254314	2	2	3.13	79.4	5.45	138.5	5.87	149.0	9.69	246.0	DG

*DG=Dual-Grip



Caterpillar® Flange

Part Number	Product Number	SAP Number									Skive Type*
			Hose ID	Flange Size	Flange Diameter (A)		Cut-Off (C)		Length (L)		
			in.		in.	mm	in.	mm	in.	mm	
S6-CF-2424	30185-2424	20293347	1 ½	1 ½	2.50	63.5	3.50	89.0	6.77	172.0	NS
S6-CF-3232	30185-3232	20293348	2	2	3.13	79.4	4.34	110.1	8.26	209.9	NS

*NS=Non-Skive

Caterpillar® Flange

22.5° Elbow

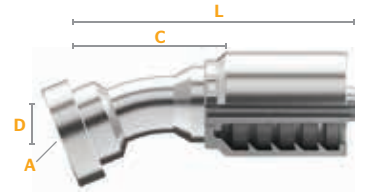

Part Number	Product Number	SAP Number	Flange Size		Flange Diameter (A)		Drop (D)		Cut-Off (C)		Length (L)		Skive Type*
			Hose ID	Flange Size	in.	mm	in.	mm	in.	mm	in.	mm	
S6-CF22-3232	30187-3232	20788095	2	2	3.13	79.4	0.98	25.0	4.34	110.1	8.26	209.9	NS

*NS=Non-Skive

Caterpillar® Flange

30° Elbow

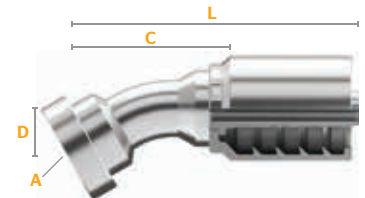

Part Number	Product Number	SAP Number	Flange Size		Flange Diameter (A)		Drop (D)		Cut-Off (C)		Length (L)		Skive Type*
			Hose ID	Flange Size	in.	mm	in.	mm	in.	mm	in.	mm	
S6-CF30-3232	30188-3232	20788096	2	2	3.13	79.4	1.38	35.0	6.54	166.2	10.47	266.0	NS

*NS=Non-Skive

Caterpillar® Flange

45° Elbow

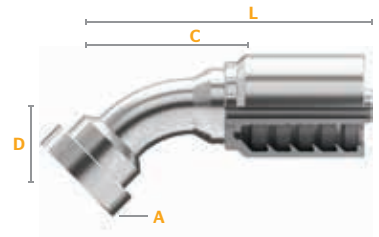

Part Number	Product Number	SAP Number	Flange Size		Flange Diameter (A)		Drop (D)		Cut-Off (C)		Length (L)		Skive Type*
			Hose ID	Flange Size	in.	mm	in.	mm	in.	mm	in.	mm	
S6-CF45-2424	30190-2424	20424964	1 ½	1 ½	2.50	63.5	2.05	52.0	7.13	181.0	10.39	264.0	NS
S6-CF45-3232	30190-3232	20441298	2	2	3.13	79.4	2.76	70.0	6.54	166.2	10.47	266.0	NS

*NS=Non-Skive



Download the **MyCrimp App** for more information.

Section 3
S6 + DG Fittings

FITTINGS



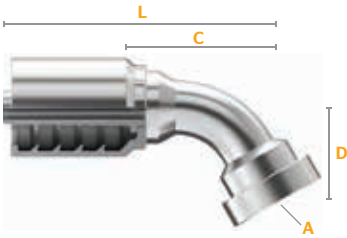

Caterpillar® Flange

60° Elbow



Part Number	Product Number	SAP Number	Flange Size		Flange Diameter (A)		Drop (D)		Cut-Off (C)		Length (L)		Skive Type*
			Hose ID	Flange Size	in.	mm	in.	mm	in.	mm	in.	mm	
S6-CF60-2424	30192-2424	20441299	1 ½	1 ½	2.50	63.5	2.85	72.5	6.46	164.0	9.76	248.0	NS
S6-CF60-2432	30192-2432	20441335	1 ½	2	3.13	79.4	3.35	85.0	5.71	145.0	8.98	228.0	NS
S6-CF60-3232	30192-3232	20441300	2	2	3.13	79.4	3.27	83.0	6.54	166.2	10.47	266.0	NS

*NS=Non-Skive

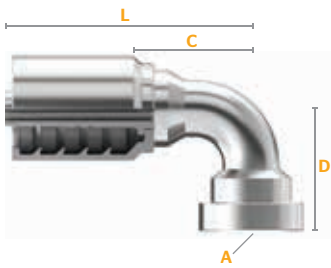

Caterpillar® Flange

90° Elbow



Part Number	Product Number	SAP Number	Flange Size		Flange Diameter (A)		Drop (D)		Cut-Off (C)		Length (L)		Skive Type*
			Hose ID	Flange Size	in.	mm	in.	mm	in.	mm	in.	mm	
S6-CF90-2424	30195-2424	20424954	1 ½	1 ½	2.50	63.5	4.29	109.0	4.61	117.0	7.87	200.0	NS
S6-CF90-3232	30195-3232	20441302	2	2	3.13	79.4	5.43	138.0	5.71	145.0	9.637	244.8	NS

*NS=Non-Skive



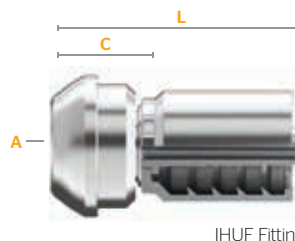

Hammer Union

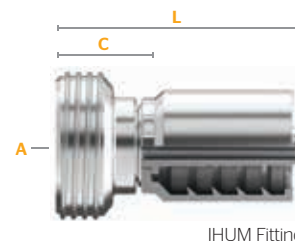

IHUF Fitting



IHUM Fitting

Part Number	Product Number	SAP Number							Skive Type*
			Hose ID	Thread Size (A)	Cut-Off (C)		Length (L)		
			in.		in.	mm	in.	mm	
S6-IHUF1502-2432	30390-2432	20864300	1 ½	2-11 1/2 3 TPI ACME 2G	2.85	72.4	6.11	155.2	NS
S6-IHUM1502-2432	30395-2432	20864272	1 ½	2-11 1/2 3 TPI ACME 2G	2.59	65.8	5.85	148.6	NS
S6-IHUF1502-3232	30390-3232	20806362	2	2-11 1/2 3 TPI ACME 2G	2.59	65.8	6.52	165.6	NS
S6-IHUM1502-3232	30395-3232	20806363	2	2-11 1/2 3 TPI ACME 2G	2.62	66.5	6.55	166.4	NS

BSPB (British Standard Pipe Parallel)

Female / Swivel

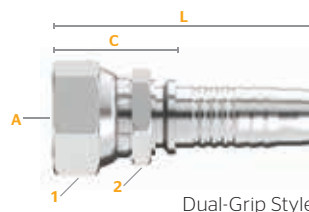



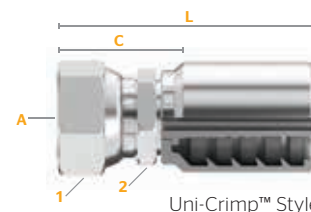

Dual-Grip Style







Uni-Crimp™ Style

Uni-Crimp™ Style

Part Number	Product Number	SAP Number								Skive Type*
			Hose ID	Thread Size (A)	Hex 1 Wrench Size	Cut-Off (C)		Length (L)		
			in.		mm	in.	mm	in.	mm	
S6-BPFX-3232	30105-3232	20788090	2	2-11	70	2.38	60.4	6.305	160.1	NS

*NS=Non-Skive

Dual-Grip Style

Part Number	Product Number	SAP Number								Skive Type*
			Hose ID	Thread Size (A)	Hex 1 Wrench Size	Cut-Off (C)		Length (L)		
			in.		mm	in.	mm	in.	mm	
DG-BPFX-3232 ^T	16105-3232	20242791	2	2-11	70	1.30	33.0	5.75	146.1	DG

^T=Thrust-Wire Nut (See Fitting Identification in Appendix for more information.) *DG=Dual-Grip



Download the **MyCrimp App** for more information.

Section 3
S6 + DG Fittings

FITTINGS



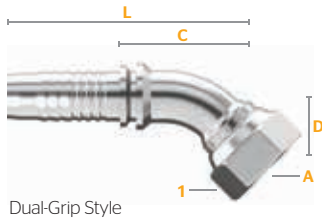
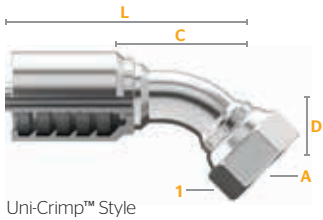

BSPB (British Standard Pipe Parallel)

Female / 45° Elbow / Swivel

Uni-Crimp™ Style

Part Number	Product Number	SAP Number	Hose ID	Thread Size (A)	Hex 1 Wrench Size	Drop (D)	Cut-Off (C)	Length (L)	Skive Type*
			in.		mm	in. mm	in. mm	in. mm	
S6-BPFX45-3232	30115-3232	20788091	2	2-11	70	2.76 70.0	6.54 166.2	10.47 266.0	NS

*NS=Non-Skive

Dual-Grip Style

Part Number	Product Number	SAP Number	Hose ID	Thread Size (A)	Hex 1 Wrench Size	Drop (D)	Cut-Off (C)	Length (L)	Skive Type*
			in.		mm	in. mm	in. mm	in. mm	
DG-BPFX45-2424 ^T	16115-2424	20242286	1 ½	1 ½-11	55	1.81 46.0	4.45 113.0	8.29 210.6	DG
DG-BPFX45-3232 ^T	16115-3232	20242788	2	2-11	70	2.36 60.0	5.94 151.0	10.08 256.0	DG

T=Thrust-Wire Nut (See Fitting Identification in Appendix for more information.) *DG=Dual-Grip

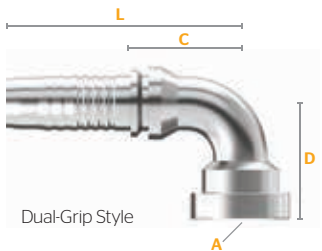
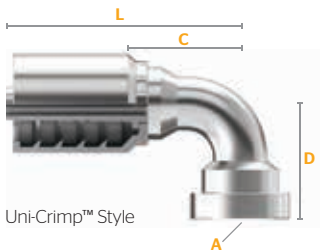

BSPB (British Standard Pipe Parallel)

Female / 90° Elbow / Swivel

Uni-Crimp™ Style

Part Number	Product Number	SAP Number	Hose ID	Thread Size (A)	Hex 1 Wrench Size	Drop (D)	Cut-Off (C)	Length (L)	Skive Type*
			in.		mm	in. mm	in. mm	in. mm	
S6-BPFX90-2424	30110-2424	20424917	1 ½	1 ½-11	55		Contact Continental		NS
S6-BPFX90-3232	30120-3232	20788092	2	2-11	70	5.51 140.0	5.71 145.0	9.627 244.5	NS

*NS=Non-Skive

Dual-Grip Style





Part Number	Product Number	SAP Number	Hose ID	Thread Size (A)	Hex 1 Wrench Size	Drop (D)	Cut-Off (C)	Length (L)	Skive Type*
			in.		mm	in. mm	in. mm	in. mm	
DG-BPFX90-2424 ^T	16120-2424	20242789	1 ½	1 ½-11	55	3.78 96.0	3.66 93.0	7.28 185.0	DG
DG-BPFX90-3232 ^T	16120-3232	20242790	2	2-11	70	4.92 125.0	5.47 139.0	9.29 236.0	DG

T=Thrust-Wire Nut (See Fitting Identification in Appendix for more information.) *DG=Dual-Grip

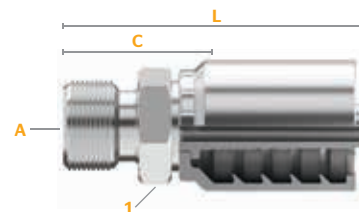
BSPP (British Standard Pipe Parallel)

Male







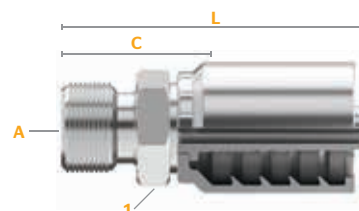

Part Number	Product Number	SAP Number							Skive Type*	
			Hose ID	Thread Size (A)	Hex 1 Wrench Size	Cut-Off (C)	Length (L)			
			in.		mm	in.	mm	in.	mm	
S6-BPM-2424	30130-2424	20424951	1 1/2	1 1/2-11	50	2.20	55.9	5.466	138.8	NS
S6-BPM-3232	30130-3232	20788093	2	2-11	70	2.66	67.5	6.587	167.3	NS

*NS=Non-Skive

BSPT (British Standard Pipe Tapered)

Male



Part Number	Product Number	SAP Number							Skive Type*	
			Hose ID	Thread Size (A)	Hex 1 Wrench Size	Cut-Off (C)	Length (L)			
			in.		mm	in.	mm	in.	mm	
S6-BTM-3232	30170-3232	20788094	2	2-11	70	2.53	64.1	6.453	163.9	NS

*DG=Dual-Grip



Download the **MyCrimp App** for more information.

Section 3
S6 + DG Fittings

FITTINGS



SECTION 4 - BT FITTINGS

This section lists all fittings compatible with the following hose:

Hose	Description	Compatible Dash Size
HR4	SAE 100R4	All hose dash sizes

How to Use the Fittings Table





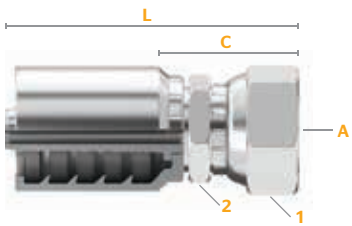

The fittings in this section will follow a similar table structure to the one seen on this page.

Fitting dimensions and attributes are explained below.



Fitting Name

Fitting Description

Part Number	Product Number	SAP Number										
			Hose ID	Thread Size (A)	Hex 1 Wrench Size	Hex 2 Wrench Size	Cut-Off (C)	Length (L)				
			in.		in.	mm	in.	mm	in.	mm		
BTJCFX-1212	37400-1212	21007489	3/4	1 1/16-12	1 1/4	32	1 1/16	27	1.74	44.2	3.29	83.6
BTJCFX-1616	37400-1616	21007491	1	1 1/16-12	1 1/2	38	1 1/4	32	1.96	49.8	3.74	94.9
BTJCFX-2020†	37400-2020	21007492	1 1/4	1 1/8-12	2	50	1 3/8	41	2.15	54.6	4.20	106.6

Fitting Dimensions and Attributes

Part Number See Hydraulic Fittings Nomenclature on page 128 for a breakdown of part number attributes

Hose ID The compatible Hose ID

Tube ID The compatible Tube ID

Thread Size The thread size or sizes available for a particular fitting dash size (indicated by **A** in the fitting image)

Hex Size The wrench size for one or both nuts on the fitting (indicated by **1** or **2** in the fitting image)

Drop The length of the elbow (indicated by **D** in the fitting image)

Cut-Off The amount of hose to be cut for a correct assembly length (indicated by **C** in the fitting image)

Length The overall length of the fitting

Skive Type For applicable fittings, a skive type will be indicated as Skive, Non-Skive or Dual-Grip

Choose fittings carefully, considering the working pressure of both the hose and fitting. The maximum working pressure of the hose assembly is the lesser of the rated working pressure of the hose and the fitting. See page 389 for the Fittings Working Pressure Guide.

BT Fittings Overview

A complete overview of all BT fittings found in this section.

JIC 37° Flare (SAE J514)

Female
Swivel



BT-JCFX

P. 238

JIC 37° Flare (SAE J514)

Female
45° Elbow
Swivel



BT-JCFX45

P. 238

JIC 37° Flare (SAE J514)

Female
90° Elbow
Swivel



BT-JCFX90

P. 239

JIC 37° Flare (SAE J514)

Male



BT-JCM

P. 239

NPTF

Male



BT-NPM

P. 240

O-Ring Face Seal (SAE J1453 ORS/ORFS)

Female
Swivel



BT-OFFX

P. 240

Code 61 Flange (SAE J518)



BT-FL

P. 241

Code 61 Flange (SAE J518)

90° Elbow



BT-FL90

P. 241



Download the **MyCrimp App**
for more information.

Section 4
BT Fittings





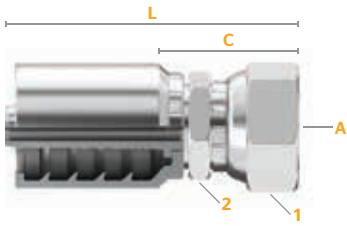

FITTINGS





JIC 37° Flare (SAE J514)

Female / Swivel





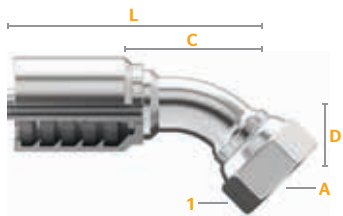

Part Number	Product Number	SAP Number										
			Hose ID	Thread Size (A)	Hex 1 Wrench Size	Hex 2 Wrench Size	Cut-Off (C)		Length (L)			
			in.		in.	mm	in.	mm	in.	mm	in.	mm
BT-JCFX-1210	37400-1210	21007488	3/4	7/8-14	1 ¼	32	1 ⅙	27	1.63	41.4	3.18	80.8
BT-JCFX-1212	37400-1212	21007489	3/4	1 ⅙-12	1 ¼	32	1 ⅙	27	1.74	44.2	3.29	83.6
BT-JCFX-1216	37400-1216	21007490	3/4	1 ⅙-12	1 ½	38	1 ¼	32	1.89	48.1	3.45	87.5
BT-JCFX-1616	37400-1616	21007491	1	1 ⅙-12	1 ½	38	1 ¼	32	1.96	49.8	3.74	94.9
BT-JCFX-2020 ^T	37400-2020	21007492	1 ¼	1 ⅙-12	2	50	1 ⅝	41	2.15	54.6	4.20	106.6
BT-JCFX-2424 ^T	37400-2424	21007493	1 ½	1 ⅙-12	2 ⅜	55	2	50	2.42	61.4	4.75	120.6
BT-JCFX-3232 ^T	37400-3232	21007494	2	2 ½-12	2 ⅝	70	2 ⅝	65	2.88	73.1	5.71	145.1

T=Thrust-Wire Nut (See Fitting Identification in Appendix for more information.)



JIC 37° Flare (SAE J514)

Female / 45° Elbow / Swivel

Part Number	Product Number	SAP Number										
			Hose ID	Thread Size (A)	Hex 1 Wrench Size	Drop (D)	Cut-Off (C)		Length (L)			
			in.		in.	mm	in.	mm	in.	mm	in.	mm
BT-JCFX45-1212	37420-1212	21007495	3/4	1 ⅙-12	1 ¼	32	0.83	21.0	2.64	67.0	4.19	106.5
BT-JCFX45-1616	37420-1616	21007496	1	1 ⅙-12	1 ½	38	0.95	24.0	3.11	79.0	4.89	124.1
BT-JCFX45-2020 ^T	37420-2020	21007497	1 ¼	1 ⅙-12	2	50	1.46	37.1	3.82	97.0	5.87	149.0
BT-JCFX45-2424 ^T	37420-2424	21007498	1 ½	1 ⅙-12	2 ⅜	55	1.69	42.9	4.45	113.0	6.78	172.2

T=Thrust-Wire Nut (See Fitting Identification in Appendix for more information.)

JIC 37° Flare (SAE J514)

Female / 90° Elbow / Swivel

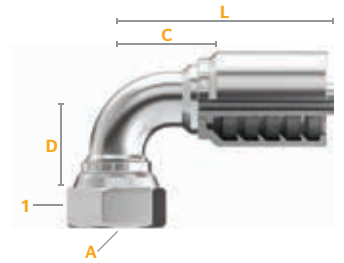

Part Number	Product Number	SAP Number	Hose ID		Thread Size (A)		Hex 1 Wrench Size		Elbow Type*	Drop (D)		Cut-Off (C)		Length (L)	
			in.	mm	in.	mm	in.	mm		in.	mm	in.	mm		
BT-JCFX90-1212	37425-1212	21007499	3/4		1 1/16	-12	1 1/4	32		2.13	54.0	2.05	52.0	3.60	91.4
BT-JCFX90L-1212	37440-1212	21007501	3/4		1 1/16	-12	1 1/4	32	LT	3.74	95.0	2.13	54.0	3.68	93.4
BT-JCFX90S-1212	37445-1212	21007500	3/4		1 1/16	-12	1 1/4	32	ST	1.81	46.0	2.28	58.0	3.84	97.4
BT-JCFX90-1616	37425-1616	21007502	1		1 3/16	-12	1 1/2	38		2.81	71.4	2.89	73.4	4.67	118.5
BT-JCFX90L-1616	37440-1616	21007504	1		1 3/16	-12	1 1/2	38	LT	4.49	114.0	3.11	79.0	4.89	124.1
BT-JCFX90S-1616	37445-1616	21007503	1		1 3/16	-12	1 1/2	38	ST	2.21	56.0	2.91	74.0	4.69	119.1
BT-JCFX90-2020 ^T	37425-2020	21007505	1 1/4		1 5/8	-12	2	50		3.07	78.0	3.23	82.0	5.28	134.0
BT-JCFX90-2424 ^T	37425-2424	21007506	1 1/2		1 7/8	-12	2 3/16	55		3.62	91.9	3.94	100.0	6.27	159.1
UC-JCFX90-3232 ^T	37425-3232	21007507	2		2 1/2	-12	2 5/16	70		5.51	140.0	5.08	129.0	7.91	201.0

^T=Thrust-Wire Nut (See Fitting Identification in Appendix for more information.) *Elbow Type: LT=Long Tube ST=Short Tube

JIC 37° Flare (SAE J514)

Male

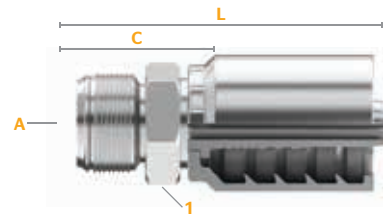

Part Number	Product Number	SAP Number	Hose ID		Thread Size (A)		Hex 1 Wrench Size		Cut-Off (C)		Length (L)	
			in.	mm	in.	mm	in.	mm	in.	mm		
BT-JCM-1212	37450-1212	21007508	3/4		1 1/16	-12	1 1/16	27	1.48	37.7	3.04	77.1
BT-JCM-1616	37450-1616	21007509	1		1 3/16	-12	1 7/16	36	1.67	42.4	3.45	87.5
BT-JCM-2020	37450-2020	21007510	1 1/4		1 5/8	-12	1 9/16	46	1.91	48.6	3.96	100.5
BT-JCM-2424	37450-2424	21007511	1 1/2		1 7/8	-12	2	50	2.08	52.7	4.40	111.8



Download the **MyCrimp App** for more information.

Section 4
BT Fittings



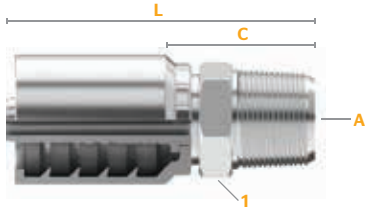

FITTINGS





NPTF





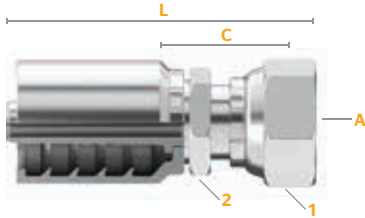

Male

Part Number	Product Number	SAP Number								
			Hose ID	Thread Size (A)	Hex 1 Wrench Size	Hex 2 Wrench Size	Cut-Off (C)	Length (L)	in.	mm
BT-NPM-1212	37615-1212	21007512	in.		in.	mm	in.	mm	in.	mm
BT-NPM-1616	37615-1616	21007513	3/4	3/4-14	1 1/16	27	1.36	34.6	2.92	74.1
BT-NPM-2020	37615-2020	21007514	1	1-11 1/2	1 1/16	36	1.73	43.9	3.51	89.0
BT-NPM-2424	37615-2424	21007515	1 1/4	1 1/4-11 1/2	1 3/16	46	1.95	49.5	4.00	101.5
BT-NPM-3232	37615-3232	21007516	1 1/2	1 1/2-11 1/2	2	50	2.01	51.0	4.34	110.1
BT-NPM-3232	37615-3232	21007516	2	2-11 1/2	2 3/16	65	2.14	54.5	4.98	126.4







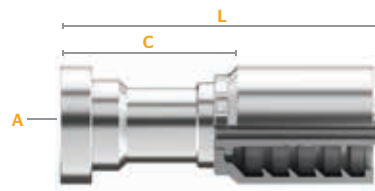

O-Ring Face Seal (SAE J1453 ORS/ORFS)

Female / Swivel

Part Number	Product Number	SAP Number										
			Hose ID	Thread Size (A)	Hex 1 Wrench Size	Hex 2 Wrench Size	Cut-Off (C)	Length (L)	in.	mm	in.	mm
BT-OFFX-1212	37700-1212	21007517	in.		in.	mm	in.	mm	in.	mm	in.	mm
BT-OFFX-1616	37700-1616	21007518	3/4	1 3/16-12	1 1/16	36	1 3/16	30	1.67	42.3	3.22	81.8
BT-OFFX-2020	37700-2020	21007519	1	1 7/16-12	1 5/8	41	1 7/16	36	1.95	49.4	3.72	94.5
BT-OFFX-2424	37700-2424	21007520	1 1/4	1 1/16-12	2	50	1 5/8	41	2.08	52.9	4.13	104.9
BT-OFFX-2424	37700-2424	21007520	1 1/2	2-12	2 3/8	60	2	50	2.23	56.7	4.56	115.8

Code 61 Flange (SAE J518)







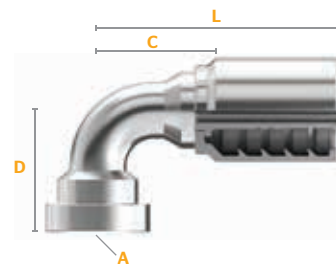

Part Number	Product Number	SAP Number								
			Hose ID	Flange Size	Flange Diameter (A)		Cut-Off (C)		Length (L)	
			in.		in.	mm	in.	mm	in.	mm
BT-FL-1212	37320-1212	21007426	3/4	3/4	1.50	38.1	1.67	42.4	3.22	81.9
BT-FL-1616	37320-1616	21007427	1	1	1.75	44.5	2.02	51.3	3.80	96.4
BT-FL-2020	37320-2020	21007428	1 ¼	1 ¼	2.00	50.8	2.19	55.6	4.24	107.6
BT-FL-2424	37320-2424	21007429	1 ½	1 ½	2.37	60.3	2.31	58.7	4.64	117.8
BT-FL-3232	37320-3232	21007480	2	2	2.81	71.4	2.76	70.1	5.59	142.1
BT-FL-4040	37320-4040	21007481	2 ½	2 ½	3.31	84.1	2.24	56.9	5.49	139.4

Code 61 Flange (SAE J518)

90° Elbow



Part Number	Product Number	SAP Number										
			Hose ID	Flange Size	Flange Diameter (A)		Drop (D)		Cut-Off (C)		Length (L)	
			in.		in.	mm	in.	mm	in.	mm	in.	mm
BT-FL90-1212	37350-1212	21007482	3/4	3/4	1.50	38.1	2.36	59.9	2.28	57.9	3.83	97.4
BT-FL90-1616	37350-1616	21007483	1	1	1.75	44.5	2.64	67.1	2.80	71.1	4.58	116.2
BT-FL90-2020	37350-2020	21007484	1 ¼	1 ¼	2.00	50.8	3.31	84.1	3.46	87.9	5.51	139.9
BT-FL90-2424	37350-2424	21007485	1 ½	1 ½	2.37	60.3	3.58	90.9	4.13	104.9	6.46	164.0
BT-FL90-3232	37350-3232	21007486	2	2	2.81	71.4	5.12	130.0	5.08	129.0	7.91	201.0
BT-FL90-4040	37350-4040	21007487	2 ½	2 ½	3.31	84.1	5.75	146.0	6.30	160.0	9.55	242.5



Download the **MyCrimp App** for more information.

Section 4
BT Fittings

FITTINGS



SECTION 5 - UC FITTINGS

This section lists all fittings compatible with the following hose:

Hose	Description	Compatible Dash Size	Hose	Description	Compatible Dash Size
SR1SN	SAE 100R1AT / EN 853 1SN	Hose dash size -03	HR6	SAE 100R6 / EN 854 R6	Hose dash size -03
SR2SN	SAE 100R2AT / EN 856 2SN	Hose dash size -03	SR14A	SAE 100R14A	Hose dash size -03
SR3	SAE 100R3 / EN 854 R3	Hose dash size -03	SFS	Fire Suppression	Hose dash size -03
SR5	SAE 100R5	Hose dash size -03	SCP3	SAE 100R17	Hose dash sizes below -16
DR5	SAE 100R5	Hose dash size -03	ACP3	SAE 100R17	Hose dash sizes below -10
SR6	SAE J1942	Hose dash size -03	BOP	Blowout Prevention	Hose dash sizes below -16
HR4	SAE 100R4	All hose dash sizes			

How to Use the Fittings Table

The fittings in this section will follow a similar table structure to the one seen on this page.

Fitting dimensions and attributes are explained below.

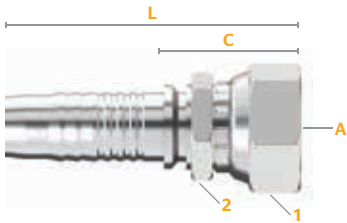

Fitting Name

Fitting Description

Part Number	Product Number	SAP Number	Thread Size (A)		Hex 1 Wrench Size		Hex 2 Wrench Size		Cut-Off (C)		Length (L)	
			Hose ID	Thread Size (A)	in.	mm	in.	mm	in.	mm	in.	mm
UC-JCFX-0505	36400-0505	20242676	5/16	1/2-20	11/16	17	9/16	14	1.24	31.4	2.22	56.3
UC-JCFX-0606	36400-0606	20242787	3/8	9/16-18	3/4	19	11/16	17	1.22	31.1	2.27	57.7
UC-JCFX-0708	36400-0708	20979891	13/32	3/4-16	1	25	3/4	19	1.374	34.9	2.423	61.5

Fitting Dimensions and Attributes

Part Number See Hydraulic Fittings Nomenclature on page 128 for a breakdown of part number attributes

Hose ID The compatible Hose ID

Tube ID The compatible Tube ID

Thread Size The thread size or sizes available for a particular fitting dash size (indicated by **A** in the fitting image)

Hex Size The wrench size for one or both nuts on the fitting (indicated by **1** or **2** in the fitting image)

Drop The length of the elbow (indicated by **D** in the fitting image)

Cut-Off The amount of hose to be cut for a correct assembly length (indicated by **C** in the fitting image)

Length The overall length of the fitting

Skive Type For applicable fittings, a skive type will be indicated as Skive, Non-Skive or Dual-Grip

Choose fittings carefully, considering the working pressure of both the hose and fitting. The maximum working pressure of the hose assembly is the lesser of the rated working pressure of the hose and the fitting. See page 389 for the Fittings Working Pressure Guide.

FITTINGS



Section 5 UC Fittings





























COMPATIBLE HOSE:

SR1SN	SR5	HR6	SFS	ACP3
SR2SN	DR5	HR4	SCP3	BOP
SR3	SR6	SR14A		

For a detailed list, please refer to your Crimp Specifications Manual.

UC Fittings Overview

A complete overview of all UC fittings found in this section.

<p>JIC 37° Flare (SAE J514) Female Swivel</p>  <p>UC-JCFX P. 245</p>	<p>JIC 37° Flare (SAE J514) Female 45° Elbow Swivel</p>  <p>UC-JCFX45 P. 246</p>	<p>JIC 37° Flare (SAE J514) Female 90° Elbow Swivel</p>  <p>UC-JCFX90 P. 247</p>	<p>JIC 37° Flare (SAE J514) Male</p>  <p>UC-JCM P. 249</p>
<p>SAE 45° J512 Flare Female Swivel</p>  <p>UC-SFFX P. 250</p>	<p>SAE 45° J512 Flare Female 45° Elbow Swivel</p>  <p>UC-SFFX45 P. 250</p>	<p>SAE 45° J512 Flare Female 90° Elbow Swivel</p>  <p>UC-SFFX90 P. 251</p>	<p>SAE 45° J512 Flare Male</p>  <p>UC-SFM P. 251</p>
<p>SAE 45° Inverted Flare Male Swivel</p>  <p>UC-SIMX P. 252</p>	<p>SAE 45° Inverted Flare Female 45° Elbow Swivel</p>  <p>UC-SIMX45 P. 252</p>	<p>SAE 45° Inverted Flare Male 90° Elbow Swivel</p>  <p>UC-SIMX90 P. 253</p>	<p>NPTF Female</p>  <p>UC-NPF P. 253</p>
<p>NPTF Male</p>  <p>UC-NPM P. 254</p>	<p>NPTF Male Swivel</p>  <p>UC-NPMX P. 255</p>	<p>NPTF Male 90° Block Elbow Swivel</p>  <p>UC-NPMX90B P. 256</p>	<p>NPSM Female Swivel</p>  <p>UC-NSFX P. 256</p>
<p>SAE J514 Flareless Tube Fittings Male</p>  <p>UC-FTM P. 257</p>	<p>Standpipe 45° Elbow</p>  <p>UC-SP P. 257</p>	<p>Standpipe 45° Elbow</p>  <p>UC-SP45 P. 258</p>	<p>O-Ring Face Seal (SAE J1453 ORS/ORFS) Female Swivel</p>  <p>UC-OFFX P. 258</p>
<p>O-Ring Face Seal (SAE J1453 ORS/ORFS) Female 45° Elbow Swivel</p>  <p>UC-OFFX45 P. 259</p>	<p>O-Ring Face Seal (SAE J1453 ORS/ORFS) Female 90° Elbow Swivel</p>  <p>UC-OFFX90 P. 260</p>	<p>O-Ring Face Seal (SAE J1453 ORS/ORFS) Male</p>  <p>UC-OFM P. 261</p>	<p>O-Ring Boss Straight Thread (SAE J514) Male</p>  <p>UC-OBM P. 262</p>
<p>O-Ring Boss Straight Thread (SAE J514) Male Swivel</p>  <p>UC-OBMX P. 262</p>	<p>O-Ring Boss Straight Thread (SAE J514) Male 90° Block Elbow Swivel</p>  <p>UC-OBMX90B P. 263</p>	<p>Code 61 Flange (SAE J518)</p>  <p>UC-FL P. 263</p>	<p>Code 61 Flange (SAE J518) 22.5° Elbow</p>  <p>UC-FL22 P. 264</p>



Download the **MyCrimp App** for more information.

Section 5
UC Fittings

FITTINGS



UC Fittings Overview

A complete overview of all UC fittings found in this section.

Code 61 Flange (SAE J518)

30° Elbow



UC-FL30 P. 264

Code 61 Flange (SAE J518)

45° Elbow



UC-FL45 P. 265

Code 61 Flange (SAE J518)

60° Elbow



UC-FL60 P. 265

Code 61 Flange (SAE J518)

90° Elbow



UC-FL90 P. 266

Code 62 Flange (SAE J518)

30° Elbow



UC-FH P. 267

Code 62 Flange (SAE J518)

45° Elbow



UC-FH45 P. 267

Code 62 Flange (SAE J518)

90° Elbow



UC-FH90 P. 268

BSPP (British Standard Pipe Parallel)

Female Swivel



UC-BPFX P. 268

BSPP (British Standard Pipe Parallel)

Female 45° Elbow Swivel



UC-BPFX45 P. 269

BSPP (British Standard Pipe Parallel)

Female 90° Elbow Swivel



UC-BPFX90 P. 269

BSPP (British Standard Pipe Parallel)

Male



UC-BPM P. 270

BSPP (British Standard Pipe Tapered)

Male



UC-BTM P. 270

BSP Flat Seat (British Standard Pipe)

Female Swivel



UC-BFFX P. 271

DIN 24° Light

Female Swivel



UC-DLFX P. 271

DIN 24° Light

Female 45° Elbow Swivel



UC-DLFX45 P. 272

DIN 24° Light

Female 90° Elbow Swivel



UC-DLFX90 P. 272

DIN 24° Light

Male



UC-DLM P. 273

DIN 24° Heavy

Female Swivel



UC-DHFX P. 273

DIN 24° Heavy

Female 45° Elbow Swivel



UC-DHFX45 P. 274

DIN 24° Heavy

Female 90° Elbow Swivel



UC-DHFX90 P. 274

DIN 24° Heavy

Male



UC-DHM P. 275

DIN 60°

Female 45° Elbow Swivel



UC-DNFX45 P. 275

DIN 60°

Female 90° Elbow Swivel



UC-DNFX90 P. 276

Komatsu® 30° Flare with Metric Threads

Female Swivel



UC-KMFX P. 276

Komatsu® 30° Flare with Metric Threads

Female 45° Elbow Swivel



UC-KMFX45 P. 277

Komatsu® 30° Flare with Metric Threads

Female 90° Elbow Swivel



UC-KMFX90 P. 277

JIS 30° (Parallel Pipe Threads)

Female Swivel



UC-JSFX P. 278

Hose Joiner



UC-HJ P. 278





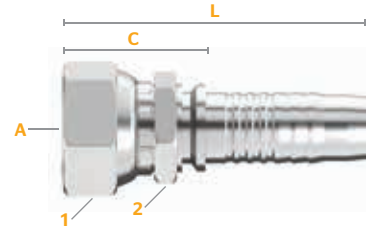

COMPATIBLE HOSE:

SR1SN	SR5	HR6	SFS	ACP3
SR2SN	DR5	HR4	SCP3	BOP
SR3	SR6	SR14A		

JIC 37° Flare (SAE J514)

Female / Swivel



Part Number	Product Number	SAP Number										
			Hose ID	Thread Size (A)	Hex 1 Wrench Size	Hex 2 Wrench Size	Cut-Off (C)		Length (L)		in.	mm
			in.		in.	mm	in.	mm	in.	mm	in.	mm
UCH-JCFX-0304	36400-0304H	20530659	3/16	7/16-20	5/8	16	1/2	12	1.07	27.2	1.94	49.4
UC-JCFX-0403	36400-0403	20318324	1/4	3/8-24	1/2	12	1/2	12	1.11	28.1	2.09	53.0
UC-JCFX-0404	36400-0404	20242786	1/4	7/16-20	5/8	16	9/16	14	1.17	29.6	2.15	54.5
UC-JCFX-0404S	36400-0404S	20540685	1/4	7/16-20	5/8	16	9/16	14	1.17	29.6	2.15	54.5
UC-JCFX-0405	36400-0405	20242746	1/4	1/2-20	11/16	17	9/16	14	1.24	31.4	2.22	56.3
UC-JCFX-0406	36400-0406	20242778	1/4	9/16-18	3/4	19	9/16	14	1.23	31.2	2.21	56.1
UC-JCFX-0504	36400-0504	20629768	5/16	7/16-20	5/8	16	9/16	14	1.20	30.4	2.18	55.3
UC-JCFX-0505	36400-0505	20242676	5/16	1/2-20	11/16	17	9/16	14	1.24	31.4	2.22	56.3
UC-JCFX-0506	36400-0506	20242765	5/16	9/16-18	3/4	19	9/16	14	1.23	31.2	2.21	56.1
UC-JCFX-0604	36400-0604	20688966	3/8	7/16-20	5/8	16	11/16	17	1.237	31.4	2.217	56.3
UC-JCFX-0606	36400-0606	20242787	3/8	9/16-18	3/4	19	11/16	17	1.22	31.1	2.27	57.7
UC-JCFX-0606S	36400-0606S	20540686	3/8	9/16-18	3/4	19	11/16	17	1.22	31.1	2.27	57.7
UC-JCFX-0608	36400-0608	20242779	3/8	3/4-16	1	25	3/4	19	1.37	34.9	2.42	61.5
UC-JCFX-0608S	36400-0608S	20873146	3/8	3/4-16	1	25	3/4	19	1.37	34.9	2.42	61.5
UC-JCFX-0610	36400-0610	20242708	3/8	7/8-14	1 1/16	27	7/8	22	1.53	38.8	2.58	65.5
UC-JCFX-0706	36400-0706	20979890	13/32	9/16-18	3/4	19	11/16	17	1.223	31.1	2.272	57.7
UC-JCFX-0708	36400-0708	20979891	13/32	3/4-16	1	25	3/4	19	1.374	34.9	2.423	61.5
UC-JCFX-0710	36400-0710	20979892	13/32	7/8-14	1 1/16	27	7/8	22	1.529	38.8	2.578	65.5
UC-JCFX-0806	36400-0806	20242666	1/2	9/16-18	3/4	19	3/4	19	1.29	32.8	2.54	64.5
UC-JCFX-0808	36400-0808	20242785	1/2	3/4-16	1	25	3/4	19	1.44	36.7	2.69	68.4
UC-JCFX-0808S	36400-0808S	20540687	1/2	3/4-16	1	25	3/4	19	1.44	36.7	2.69	68.4
UC-JCFX-0810	36400-0810	20242772	1/2	7/8-14	1 1/16	27	7/8	22	1.56	39.6	2.81	71.3
UC-JCFX-0812	36400-0812	20242727	1/2	1 1/16-12	1 1/4	32	1	25	1.68	42.6	2.93	74.3
UC-JCFX-1008	36400-1008	20242399	5/8	3/4-16	1	25	15/16	24	1.52	38.7	2.88	73.2
UC-JCFX-1010	36400-1010	20242774	5/8	7/8-14	1 1/16	27	15/16	24	1.67	42.4	3.03	76.9
UC-JCFX-1010S	36400-1010S	20540688	5/8	7/8-14	1 1/16	27	15/16	24	1.67	42.4	3.03	76.9
UC-JCFX-1012	36400-1012	20242580	5/8	1 1/16-12	1 1/4	32	1	25	1.68	42.6	3.04	77.1
UC-JCFX-1210	36400-1210	20242694	3/4	7/8-14	1 1/4	32	1 1/16	27	1.63	41.4	3.18	80.8
UC-JCFX-1212	36400-1212	20242783	3/4	1 1/16-12	1 1/4	32	1 1/16	27	1.74	44.2	3.29	83.6
UC-JCFX-1212S	36400-1212S	20540689	3/4	1 1/16-12	1 1/4	32	1 1/16	27	1.74	44.2	3.29	83.6
UC-JCFX-1214	36400-1214	20242613	3/4	1 3/16-12	1 1/16	36	1 1/4	32	1.76	44.6	3.31	84.0
UC-JCFX-1216	36400-1216	20242719	3/4	1 3/16-12	1 1/2	38	1 1/4	32	1.89	48.1	3.45	87.5
UC-JCFX-1416	36400-1416	20283395	7/8	1 3/16-12	1 1/2	38	1 1/4	32	1.85	47.0	3.40	86.3
UC-JCFX-1612	36400-1612	20242702	1	1 1/16-12	1 1/4	32	1 1/4	32	1.88	47.7	3.65	92.8
UC-JCFX-1616	36400-1616	20242784	1	1 3/16-12	1 1/2	38	1 1/4	32	1.96	49.8	3.74	94.9
UC-JCFX-1616S	36400-1616S	20540690	1	1 3/16-12	1 1/2	38	1 1/4	32	1.96	49.8	3.74	94.9
UC-JCFX-1620 ^T	36400-1620	20242711	1	1 3/8-12	2	50	1 3/8	41	2.07	52.5	3.84	97.6

Continued on the next page.



Download the **MyCrimp App** for more information.

Section 5 UC Fittings

FITTINGS



JIC 37° Flare (Female) Continued

Part Number	Product Number	SAP Number	Hose ID	Thread Size (A)	Hex 1 Wrench Size		Hex 2 Wrench Size		Cut-Off (C)		Length (L)	
					in.	mm	in.	mm	in.	mm	in.	mm
UC-JCFX-1816	36400-1816	20613766	1 1/8	1 1/8-12	1 1/2	38	1 1/8	41	1.80	45.8	3.56	90.4
UC-JCFX-1820	36400-1820	20283399	1 1/8	1 1/8-12	2	50	1 1/8	41	2.09	53.0	3.84	97.6
UC-JCFX-2020 ^T	36400-2020	20242781	1 1/4	1 1/8-12	2	50	1 1/8	41	2.15	54.6	4.20	106.6
UC-JCFX-2020S	36400-2020S	20676944	1 1/4	1 1/8-12	2	50	1 1/8	41	2.15	54.6	4.20	106.6
UC-JCFX-2224	36400-2224	20283397	1 3/8	1 1/8-12	2 3/16	55	2	50	2.46	62.4	4.50	114.4
UC-JCFX-2420	36400-2420	20591960	1 1/2	1 1/8-12	2	50	2	50	2.21	56.2	4.54	115.4
UC-JCFX-2424 ^T	36400-2424	20242768	1 1/2	1 1/8-12	2 3/16	55	2	50	2.42	61.4	4.75	120.6
UC-JCFX-2932	36400-2932	20283398	1 9/16	2 1/2-12	2 9/16	70	2 3/16	65	2.86	72.7	5.70	144.8
UC-JCFX-3232 ^T	36400-3232	20242754	2	2 1/2-12	2 9/16	70	2 3/16	65	2.88	73.1	5.71	145.1
UC-JCFX-3232S	36400-3232S	20672343	2	2 1/2-12	2 9/16	70	2 3/16	65	2.88	73.1	5.71	145.1

^T=Thrust-Wire Nut S=Stainless Steel (See Fitting Identification in Appendix for more information.)

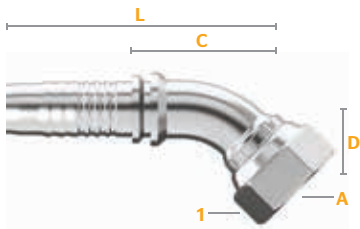

JIC 37° Flare (SAE J514)

Female / 45° Elbow / Swivel



Part Number	Product Number	SAP Number	Hose ID	Thread Size (A)	Hex 1 Wrench Size		Drop (D)	Cut-Off (C)		Length (L)		
					in.	mm		in.	mm	in.	mm	
UC-JCFX45-0304	36420-0304	20685771	3/16	7/16-20	5/8	16	0.39	100	1.44	36.6	2.31	58.8
UC-JCFX45-0404	36420-0404	20242725	1/4	7/16-20	5/8	16	0.39	100	1.46	37.0	2.44	61.9
UC-JCFX45-0405	36420-0405	20242628	1/4	1/2-20	11/16	17	0.47	120	1.46	37.0	2.44	61.9
UC-JCFX45-0406	36420-0406	20242629	1/4	9/16-18	3/4	19	0.43	110	1.54	39.0	2.52	63.9
UC-JCFX45-0506	36420-0506	20242489	5/16	9/16-18	3/4	19	0.47	11.9	1.69	42.9	2.67	67.8
UC-JCFX45-0606	36420-0606	20242743	3/8	9/16-18	3/4	19	0.43	11.0	1.81	46.0	2.86	72.6
UC-JCFX45-0608	36420-0608	20242698	3/8	3/4-16	1	25	0.59	15.0	1.85	47.0	2.90	73.6
UC-JCFX45-0706	36420-0706	20979893	13/32	9/16-18	3/4	19	0.43	11.0	1.81	46.0	2.86	72.6
UC-JCFX45-0708	36420-0708	20979894	13/32	3/4-16	1	25	0.59	15.0	1.85	47.0	2.90	73.6
UC-JCFX45-0808	36420-0808	20242729	1/2	3/4-16	1	25	0.59	15.0	2.05	52.0	3.29	83.7
UC-JCFX45-0810	36420-0810	20242675	1/2	7/8-14	1 1/8	27	0.63	16.0	2.01	51.0	3.26	82.7
UC-JCFX45-1010	36420-1010	20242345	5/8	7/8-14	1 1/8	27	0.87	22.0	2.56	65.0	3.92	99.5
UC-JCFX45-1012	36420-1012	20242344	5/8	1 1/8-12	1 1/4	32	0.83	21.0	2.72	69.0	4.07	103.5
UC-JCFX45-1212	36420-1212	20242721	3/4	1 1/8-12	1 1/4	32	0.83	21.0	2.64	67.0	4.19	106.5
UC-JCFX45-1216	36420-1216	20242343	3/4	1 1/8-12	1 1/2	38	1.02	26.0	2.80	71.0	4.35	110.4
UC-JCFX45-1416	36420-1416	20749855	7/8	1 1/8-12	1 1/2	38	1.24	31.4	3.14	79.6	4.68	118.9
UC-JCFX45-1616	36420-1616	20242742	1	1 1/8-12	1 1/2	38	0.95	24.0	3.11	79.0	4.89	124.1

Continued on the next page.

FITTINGS



Section 5

UC Fittings

COMPATIBLE HOSE:

SR1SN	SR5	HR6	SFS	ACP3
SR2SN	DR5	HR4	SCP3	BOP
SR3	SR6	SR14A		

For a detailed list, please refer to your Crimp Specifications Manual.

JIC 37° Flare (Female 45° Elbow) Continued

Part Number	Product Number	SAP Number	Hose ID	Thread Size (A)	Hex 1 Wrench Size		Drop (D)		Cut-Off (C)		Length (L)	
			in.		in.	mm	in.	mm	in.	mm	in.	mm
UC-JCFX45-1820	36420-1820	20367919	1 1/8	1 1/8-12	2	50	1.52	38.6	3.43	87.1	5.19	131.7
UC-JCFX45-2020 ^T	36420-2020	20242710	1 1/4	1 1/8-12	2	50	1.46	37.1	3.82	97.0	5.87	149.0
UC-JCFX45-2424 ^T	36420-2424	20242632	1 1/2	1 1/8-12	2 3/16	55	1.69	42.9	4.45	113.0	6.78	172.2
UC-JCFX45-3232 ^T	36420-3232	20269237	2	2 1/8-12	2 1/16	70	2.64	67.1	6.30	160.0	9.13	232.0

^T=Thrust-Wire Nut (See Fitting Identification in Appendix for more information.)

JIC 37° Flare (SAE J514)

Female / 90° Elbow / Swivel

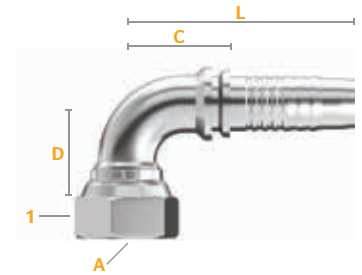

Part Number	Product Number	SAP Number	Hose ID	Thread Size (A)	Hex 1 Wrench Size		Elbow Type*	Drop (D)		Cut-Off (C)		Length (L)	
			in.		in.	mm		in.	mm	in.	mm	in.	mm
UC-JCFX90-0304	36425-0304	20269250	3/16	7/16-20	5/8	16		1.26	32.0	1.30	33.0	2.17	55.2
UC-JCFX90-0404	36425-0404	20242770	1/4	7/16-20	5/8	16		1.26	32.0	1.34	34.0	2.32	58.9
UC-JCFX90L-0404	36440-0404	20242662	1/4	7/16-20	5/8	16	LT	1.81	46.0	1.25	31.8	2.23	56.7
UC-JCFX90S-0404	36445-0404	20242430	1/4	7/16-20	5/8	16	ST	0.83	21.0	1.06	27.0	2.04	51.9
UC-JCFX90-0405	36425-0405	20242657	1/4	1/2-20	11/16	17		1.18	30.0	1.02	26.0	2.00	50.9
UC-JCFX90L-0405	36440-0405	20242473	1/4	1/2-20	11/16	17	LT	1.77	45.0	1.02	26.0	2.00	50.9
UC-JCFX90S-0405	36445-0405	20242396	1/4	1/2-20	11/16	17	ST	0.93	23.5	1.02	26.0	2.00	50.9
UC-JCFX90-0406	36425-0406	20242718	1/4	9/16-18	3/4	19		1.50	38.0	1.10	28.0	2.08	52.9
UC-JCFX90L-0406	36440-0406	20242474	1/4	9/16-18	3/4	19	LT	2.13	54.0	1.34	34.0	2.32	58.9
UC-JCFX90S-0406	36445-0406	20242397	1/4	9/16-18	3/4	19	ST	0.91	23.0	1.22	31.0	2.20	55.9
UC-JCFX90-0504	36425-0504	20612476	5/16	7/16-20	5/8	16		1.26	32.0	1.34	34.0	2.32	58.9
UC-JCFX90-0505	36425-0505	20242565	5/16	1/2-20	3/4	17		1.38	35.1	1.34	34.0	2.32	58.9
UC-JCFX90-0506	36425-0506	20242490	5/16	9/16-18	3/4	19		1.38	35.1	1.30	33.0	2.28	57.9
UC-JCFX90L-0506	36440-0506	20242454	5/16	9/16-18	3/4	19	LT	2.13	54.1	1.42	36.1	2.40	61.0
UC-JCFX90-0604	36425-0604	20318323	3/8	7/16-20	5/8	16		1.26	32.0	1.38	35.0	2.43	61.6
UC-JCFX90L-0604	36440-0604	20318322	3/8	7/16-20	5/8	16	LT	1.81	46.0	1.22	31.0	2.27	57.6
UC-JCFX90-0606	36425-0606	20242776	3/8	9/16-18	3/4	19		1.50	38.0	31	57.6	2.27	57.6
UC-JCFX90L-0606	36440-0606	20242720	3/8	9/16-18	3/4	19	LT	2.13	54.0	1.69	43.0	2.74	69.6
UC-JCFX90S-0606	36445-0606	20242475	3/8	9/16-18	3/4	19	ST	0.91	23.0	1.65	42.0	2.70	68.7
UC-JCFX90-0608	36425-0608	20242753	3/8	3/4-16	1	25		1.61	41.0	1.54	39.0	2.58	65.6
UC-JCFX90L-0608	36440-0608	20242587	3/8	3/4-16	1	25	LT	2.52	64.0	1.85	47.0	2.90	73.6
UC-JCFX90S-0608	36445-0608	20242431	3/8	3/4-16	1	25	ST	1.14	29.0	1.93	49.0	2.98	75.6

Continued on the next page.



Download the **MyCrimp App** for more information.

Section 5 UC Fittings

FITTINGS



JIC 37° Flare (Female 90° Elbow) Continued

Part Number	Product Number	SAP Number	Hose ID	Thread Size (A)	Hex 1 Wrench Size		Elbow Type*	Drop (D)		Cut-Off (C)		Length (L)	
					in.	mm		in.	mm	in.	mm	in.	mm
UC-JCFX90-0706	36425-0706	20979910	13/32	9/16-18	3/4	19		1.50	38.0	1.22	31.0	2.27	57.6
UC-JCFX90L-0706	36440-0706	20979912	13/32	9/16-18	3/4	19	LT	2.13	54.0	1.69	43.0	2.74	69.6
UC-JCFX90S-0706	36445-0706	20979914	13/32	9/16-18	3/4	19	ST	0.91	23.0	1.65	42.0	2.70	68.7
UC-JCFX90-0708	36425-0708	20979911	13/32	3/4-16	1	25		1.61	41.0	1.54	39.0	2.58	65.6
UC-JCFX90L-0708	36440-0708	20979913	13/32	3/4-16	1	25	LT	2.52	64.0	1.85	47.0	2.89	73.6
UC-JCFX90S-0708	36445-0708	20979895	13/32	3/4-16	1	25	ST	1.14	29.0	1.93	49.0	2.98	75.6
UC-JCFX90-0808	36425-0808	20242764	1/2	3/4-16	1	25		1.58	40.0	1.46	37.0	2.70	68.7
UC-JCFX90L-0808	36440-0808	20242688	1/2	3/4-16	1	25	LT	2.52	64.0	1.97	50.0	3.22	81.7
UC-JCFX90S-0808	36445-0808	20242429	1/2	3/4-16	1	25	ST	1.14	29.0	1.81	46.0	3.06	77.7
UC-JCFX90-0810	36425-0810	20242706	1/2	7/8-14	1 1/16	27		1.85	47.0	1.69	43.0	2.94	74.7
UC-JCFX90L-0810	36440-0810	20242584	1/2	7/8-14	1 1/16	27	LT	2.56	65.0	1.46	37.0	2.70	68.7
UC-JCFX90S-0810	36445-0810	20242395	1/2	7/8-14	1 1/16	27	ST	1.26	32.0	1.81	46.0	3.06	77.7
UC-JCFX90-0812	36425-0812	20242349	1/2	1 1/16-12	1 1/4	32		1.81	46.0	1.46	37.0	2.70	68.7
UC-JCFX90-1010	36425-1010	20242749	5/8	7/8-14	1 1/16	27		1.89	48.0	1.93	49.0	3.29	83.5
UC-JCFX90L-1010	36440-1010	20242346	5/8	7/8-14	1 1/16	27	LT	2.56	65.0	1.97	50.0	3.32	84.4
UC-JCFX90S-1010	36445-1010	20591962	5/8	7/8-14	1 1/16	27	ST	1.26	32.0	1.93	49.0	3.29	83.5
UC-JCFX90-1012	36425-1012	20242350	5/8	1 1/16-12	1 1/4	32		2.28	58.0	1.89	48.0	3.25	82.5
UC-JCFX90L-1012	36440-1012	20283400	5/8	1 1/16-12	1 1/4	32	LT	3.78	96.0	2.35	59.7	3.71	94.2
UC-JCFX90L-1210	36440-1210	20591961	3/4	7/8-14	1 1/16	27	LT	2.76	70.0	1.97	50.0	3.52	89.5
UC-JCFX90S-1210	36445-1210	20613762	3/4	7/8-14	1 1/16	27	ST	1.26	32.0	1.97	50.0	3.52	89.5
UC-JCFX90-1212	36425-1212	20242756	3/4	1 1/16-12	1 1/4	32		2.13	54.0	2.05	52.0	3.60	91.4
UC-JCFX90L-1212	36440-1212	20242674	3/4	1 1/16-12	1 1/4	32	LT	3.74	95.0	2.13	54.0	3.68	93.4
UC-JCFX90S-1212	36445-1212	20591963	3/4	1 1/16-12	1 1/4	32	ST	1.81	46.0	2.28	58.0	3.84	97.4
UC-JCFX90-1216	36425-1216	20242579	3/4	1 1/16-12	1 1/2	38		2.84	72.0	2.09	53.0	3.64	92.5
UC-JCFX90-1416	36425-1416	20749859	7/8	1 1/16-12	1 1/2	38		2.85	72.3	2.93	74.5	4.48	113.7
UC-JCFX90-1616	36425-1616	20242758	1	1 1/16-12	1 1/2	38		2.81	71.4	2.89	73.4	4.67	118.5
UC-JCFX90L-1616	36440-1616	20242651	1	1 1/16-12	1 1/2	38	LT	4.49	114.0	3.11	79.0	4.89	124.1
UC-JCFX90S-1616	36445-1616	20591964	1	1 1/16-12	1 1/2	38	ST	2.21	56.0	2.91	74.0	4.69	119.1
UC-JCFX90-2020 ^T	36425-2020	20242752	1 1/4	1 1/16-12	2	50		3.07	78.0	3.23	82.0	5.28	134.0
UC-JCFX90S-2020 ^T	36445-2020	20591967	1 1/4	1 1/16-12	2	50	ST	2.52	64.0	3.23	82.0	5.28	134.0
UC-JCFX90-2424 ^T	36425-2424	20242645	1 1/2	1 1/16-12	2 3/16	55		3.62	91.9	3.94	100.0	6.27	159.1
UC-JCFX90-3232 ^T	36425-3232	20269239	2	2 1/2-12	2 9/16	70		5.51	140.0	5.08	129.0	7.91	201.0

T=Thrust-Wire Nut (See Fitting Identification in Appendix for more information.) *Elbow Type: LT=Long Tube ST=Short Tube

FITTINGS



Section 5

UC Fittings

COMPATIBLE HOSE:





SR1SN	SR5	HR6	SFS	ACP3
SR2SN	DR5	HR4	SCP3	BOP
SR3	SR6	SR14A		

For a detailed list, please refer to your Crimp Specifications Manual.

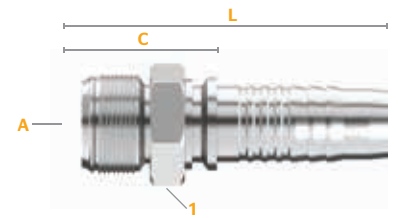
JIC 37° Flare (SAE J514)

Male



Part Number	Product Number	SAP Number								
			Hose ID	Thread Size (A)	Hex 1 Wrench Size		Cut-Off (C)		Length (L)	
			in.		in.	mm	in.	mm	in.	mm
UC-JCM-0304	36450-0304	20592795	3/16	7/16-20	1/2	12	0.98	24.8	1.85	47.0
UC-JCM-0404	36450-0404	20242728	1/4	7/16-20	1/2	12	0.99	25.2	1.97	50.1
UC-JCM-0405	36450-0405	20242664	1/4	1/2-20	9/16	14	1.03	26.2	2.01	51.1
UC-JCM-0406	36450-0406	20242687	1/4	9/16-18	11/16	17	1.04	26.4	2.02	51.3
UC-JCM-0505	36450-0505	20242588	5/16	1/2-20	9/16	14	1.04	26.3	2.02	51.2
UC-JCM-0506	36450-0506	20242434	5/16	9/16-18	11/16	17	1.04	26.5	2.02	51.4
UC-JCM-0606	36450-0606	20242759	3/8	9/16-18	11/16	17	1.05	26.6	2.10	53.2
UC-JCM-0608	36450-0608	20242755	3/8	3/4-16	3/4	19	1.14	28.9	2.19	55.5
UC-JCM-0610	36450-0610	20242630	3/8	7/8-14	15/16	24	1.33	33.8	2.38	60.5
UC-JCM-0706	36450-0706	20979915	13/32	9/16-18	11/16	17	1.05	26.6	2.10	53.2
UC-JCM-0708	36450-0708	20979916	13/32	3/4-16	3/4	19	1.14	28.9	2.19	55.5
UC-JCM-0710	36450-0710	20979917	13/32	7/8-14	15/16	24	1.33	33.8	2.38	60.5
UC-JCM-0808	36450-0808	20242736	1/2	3/4-16	3/4	19	1.17	29.8	2.42	61.4
UC-JCM-0810	36450-0810	20242716	1/2	7/8-14	15/16	24	1.35	34.4	2.60	66.0
UC-JCM-0812	36450-0812	20242670	1/2	1 1/8-12	1 1/8	27	1.46	37.1	2.71	68.7
UC-JCM-1010	36450-1010	20242435	5/8	7/8-14	15/16	24	1.38	35.0	2.73	69.4
UC-JCM-1012	36450-1012	20242400	5/8	1 1/8-12	1 1/8	27	1.46	37.1	2.82	71.5
UC-JCM-1212	36450-1212	20242732	3/4	1 1/8-12	1 1/8	27	1.48	37.7	3.04	77.1
UC-JCM-1214	36450-1214	20242542	3/4	1 3/8-12	1 1/4	32	1.62	41.0	3.17	80.5
UC-JCM-1216	36450-1216	20242634	3/4	1 7/8-12	1 7/8	36	1.66	42.2	3.21	81.6
UC-JCM-1616	36450-1616	20242747	1	1 7/8-12	1 7/8	36	1.67	42.4	3.45	87.5
UC-JCM-1620	36450-1620	20242433	1	1 3/4-12	1 3/4	46	1.84	46.8	3.62	91.9
UC-JCM-2020	36450-2020	20242712	1 1/4	1 3/8-12	1 3/8	46	1.91	48.6	3.96	100.5
UC-JCM-2024	36450-2024	20242608	1 1/4	1 7/8-12	2	50	2.08	52.8	4.12	104.7
UC-JCM-2424	36450-2424	20242625	1 1/2	1 7/8-12	2	50	2.08	52.7	4.40	111.8
UC-JCM-3232	36450-3232	20242547	2	2 1/2-12	2 3/8	65	2.45	62.1	5.28	134.1



Download the **MyCrimp App** for more information.

Section 5
UC Fittings

FITTINGS



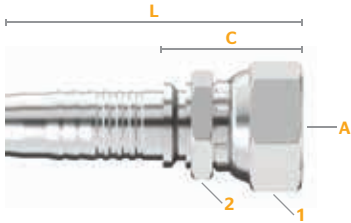

SAE 45° J512 Flare

Female / Swivel

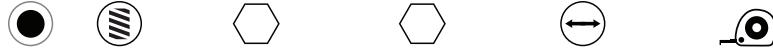

Part Number	Product Number	SAP Number	Thread		Hex 1		Hex 2		Cut-Off (C)		Length (L)	
			Hose ID	Size (A)	Wrench Size	Wrench Size	Wrench Size	Wrench Size	in.	mm	in.	mm
UC-SFFX-0304	36775-0304	20778888	3/16	7/16-20	5/8	16	1/2	13	1.07	27.2	1.94	49.4
UC-SFFX-0506	36775-0506	20778889	5/16	5/8-18	7/8	22	3/4	19	1.32	33.5	2.30	58.4
UC-SFFX-0606	36775-0606	20242760	3/8	5/8-18	7/8	22	3/4	19	1.32	33.6	2.37	60.2
UC-SFFX-0608	36775-0608	20318359	3/8	3/4-16	1	25	3/4	19	1.37	34.9	2.42	61.5
UC-SFFX-0706	36775-0706	20979936	13/32	5/8-18	7/8	22	3/4	19	1.32	33.6	2.37	60.2
UC-SFFX-0708	36775-0708	20979937	13/32	3/4-16	1	25	3/4	19	1.37	34.9	2.42	61.5
UC-SFFX-0808	36775-0808	20778907	1/2	3/4-16	1	25	7/8	22	1.44	36.7	2.69	68.4
UC-SFFX-0810	36775-0810	20778908	1/2	7/8-14	1 1/6	27	7/8	22	1.60	40.6	2.85	72.3
UC-SFFX-1212	36775-1212	20242652	3/4	1 1/6 -14	1 1/4	32	1 1/6	27	1.74	44.2	3.29	83.6

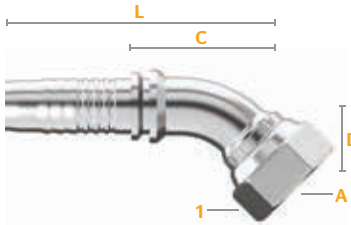

SAE 45° J512 Flare

Female / 45° Elbow / Swivel



Part Number	Product Number	SAP Number	Thread		Hex 1		Drop (D)		Cut-Off (C)		Length (L)	
			Hose ID	Size (A)	Wrench Size	Wrench Size	Wrench Size	Wrench Size	in.	mm	in.	mm
UC-SFFX45-0506	36777-0506	20778900	5/16	5/8-18	7/8	22	0.47	11.9	1.69	42.9	2.67	67.8
UC-SFFX45-0606	36777-0606	20318360	3/8	5/8-18	7/8	22	0.47	12.0	1.81	46.0	2.86	72.6
UC-SFFX45-0608	36777-0608	20778909	3/8	3/4-16	1	25	0.59	15.0	1.85	47.0	2.90	73.6
UC-SFFX45-0706	36777-0706	20979938	13/32	5/8-18	7/8	22	0.47	12.0	1.81	46.0	2.86	72.6
UC-SFFX45-0808	36777-0808	20318361	1/2	3/4-16	1	25	0.59	15.0	2.05	52.0	3.29	83.7
UC-SFFX45-0810	36777-0810	20778901	1/2	7/8-14	1 1/6	27	0.63	16.0	2.01	51.0	3.26	82.7

FITTINGS



Section 5

UC Fittings

COMPATIBLE HOSE:

- SR1SN
- SR5
- HR6
- SFS
- ACP3
- SR2SN
- DR5
- HR4
- SCP3
- BOP
- SR3
- SR6
- SR14A

For a detailed list, please refer to your Crimp Specifications Manual.

SAE 45° J512 Flare

Female / 90° Elbow / Swivel

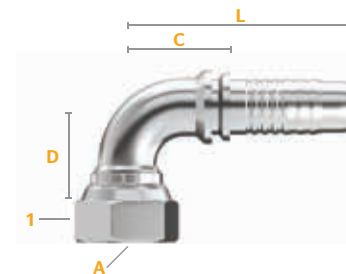

Part Number	Product Number	SAP Number	Hose ID	Thread Size (A)	Hex 1 Wrench Size	Drop (D)		Cut-Off (C)		Length (L)		
			in.		in.	mm	in.	mm	in.	mm	in.	mm
UC-SFFX90-0506	36780-0506	20778902	5/16	5/8-18	7/8	22	1.38	35.1	1.30	33.0	2.28	57.9
UC-SFFX90-0606	36780-0606	20318325	3/8	5/8-18	7/8	22	0.95	24.0	1.65	42.0	2.70	68.7
UC-SFFX90L-0606	36781-0606	20318362	3/8	5/8-18	7/8	22	2.19	55.5	1.69	43.0	2.74	69.6
UC-SFFX90-0608	36781-0608	20761705	3/8	3/4-16	1	25	1.61	41.0	1.54	39.0	2.58	65.6
UC-SFFX90S-0608	36783-0608	20778910	3/8	3/4-16	1	25	1.14	29.0	1.93	49.0	2.98	75.6
UC-SFFX90-0706	36780-0706	20979939	13/32	5/8-18	7/8	22	0.95	24.0	1.65	42.0	2.70	68.7
UC-SFFX90-0808	36781-0808	20778903	1/2	3/4-16	1	25	1.58	40.0	1.46	37.0	2.70	68.7
UC-SFFX90S-0808	36783-0808	20318363	1/2	3/4-16	1	25	1.14	29.0	1.81	46.0	3.06	77.7
UC-SFFX90-0810	36781-0810	20778904	1/2	7/8-14	1 1/16	27	2.13	54.0	2.05	52.0	3.6	91.4
UC-SFFX90S-0810	36783-0810	20778905	1/2	7/8-14	1 1/16	27	1.26	32.0	1.81	46.0	3.06	77.7

SAE 45° J512 Flare

Male

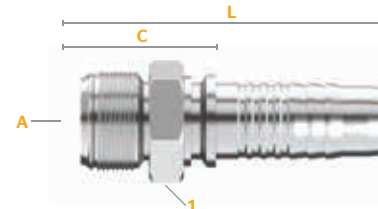

Part Number	Product Number	SAP Number	Hose ID	Thread Size (A)	Hex 1 Wrench Size	Cut-Off (C)		Length (L)		
			in.		in.	mm	in.	mm	in.	mm
UC-SFM-0606	36785-0606	20318320	3/8	5/8-18	5/8	16	1.12	28.5	2.17	55.2
UC-SFM-0608	36785-0810	20778911	3/8	3/4-16	3/4	19	1.23	31.2	2.28	57.9
UC-SFM-0706	36785-0706	20979940	13/32	5/8-18			1.12	28.5	2.17	55.2
UC-SFM-0808	36785-0808	20778906	1/2	3/4-16	3/4	19	1.27	32.1	2.51	63.8



Download the **MyCrimp App** for more information.

Section 5
UC Fittings

FITTINGS



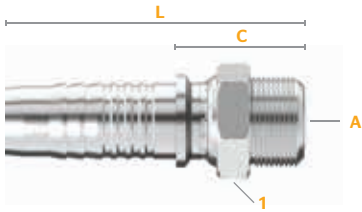

SAE 45° Inverted Flare

Male / Swivel

Part Number	Product Number	SAP Number	Hose ID		Thread Size (A)		Hex 1 Wrench Size		Cut-Off (C)		Length (L)	
			in.	mm	in.	mm	in.	mm	in.	mm	in.	mm
UC-SIMX-0403	36800-0403	20318328	1/4		3/8-24		1/2	12	1.68	42.7	2.66	67.6
UC-SIMX-0404	36800-0404	20318329	1/4		7/16-24		1/2	12	1.70	43.1	2.68	67.9
UC-SIMX-0405	36800-0405	20318330	1/4		1/2-20		9/16	14	1.83	46.6	2.81	71.5
UC-SIMX-0605	36800-0605	20318331	3/8		1/2-20		9/16	14	1.84	46.8	2.89	73.4
UC-SIMX-0606	36800-0606	20318332	3/8		5/8-18		11/16	17	1.89	48.0	2.94	74.7
UC-SIMX-0607	36800-0607	20318333	3/8		11/16-18		3/4	19	1.92	48.7	2.97	75.3
UC-SIMX-0808	36800-0808	20318334	1/2		3/4-18		3/4	19	2.00	50.8	3.25	82.5
UC-SIMX-0810	36800-0810	20318335	1/2		7/8-18		15/16	24	2.07	52.7	3.32	84.4

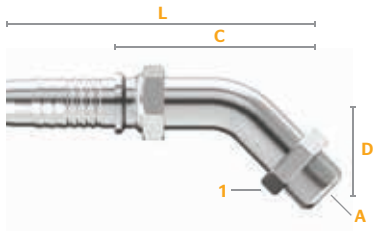

SAE 45° Inverted Flare





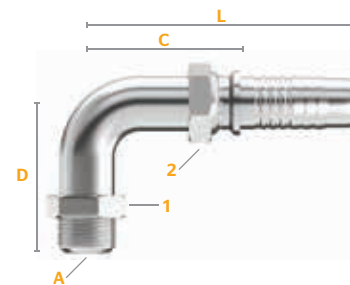

Male / 45° Elbow / Swivel

Part Number	Product Number	SAP Number	Hose ID		Thread Size (A)		Hex 1 Wrench Size		Drop (D)		Cut-Off (C)		Length (L)	
			in.	mm	in.	mm	in.	mm	in.	mm	in.	mm	in.	mm
UC-SIMX45-0403	36810-0403	20318336	1/4		3/8-24		1/2	12	1.24	31.5	2.68	68.1	3.66	93.0
UC-SIMX45-0404	36810-0404	20318337	1/4		7/16-24		1/2	12	1.24	31.5	2.68	68.1	3.66	93.0
UC-SIMX45-0604	36810-0604	20318338	3/8		7/16-24		1/2	12	1.57	39.8	2.95	74.9	4.00	101.6
UC-SIMX45-0605	36810-0605	20318339	3/8		1/2-20		9/16	14	1.50	38.1	2.99	75.9	4.04	102.6
UC-SIMX45-0606	36810-0606	20318340	3/8		5/8-18		11/16	17	1.50	38.1	2.99	75.9	4.04	102.6
UC-SIMX45-0607	36810-0607	20318341	3/8		11/16-18		3/4	19	1.50	38.1	2.99	75.9	4.04	102.6

SAE 45° Inverted Flare

Male / 90° Elbow / Swivel





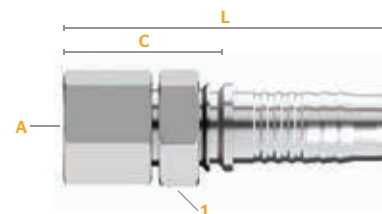

Part Number	Product Number	SAP Number										
			Hose ID	Thread Size (A)	Hex 1 Wrench Size	Drop (D)	Cut-Off (C)	Length (L)	in.	mm	in.	mm
UC-SIMX90-0404	36815-0404	20318343	1/4	7/16-24	1/2	12	2.05	52.1	1.30	33.0	2.28	57.9
UC-SIMX90-0405	36815-0405	20318344	1/4	1/2-20	9/16	14	1.96	49.8	1.52	38.6	2.50	63.5
UC-SIMX90-0604	36815-0604	20318345	3/8	7/16-24	1/2	12	2.44	62.0	1.34	34.0	2.39	60.7
UC-SIMX90-0605	36815-0605	20318346	3/8	1/2-20	9/16	14	2.44	62.0	1.38	35.1	2.43	61.7
UC-SIMX90-0606	36815-0606	20318347	3/8	5/8-18	11/16	17	2.44	62.0	1.38	35.1	2.43	61.7
UC-SIMX90-0607	36815-0607	20318348	3/8	11/16-18	3/4	19	2.44	62.0	1.38	35.1	2.43	61.7
UC-SIMX90-0808	36815-0808	20318349	1/2	3/4-18	3/4	19	2.32	58.9	2.13	54.1	3.38	85.8

NPTF

Female



Part Number	Product Number	SAP Number									
			Hose ID	Thread Size (A)	Hex 1 Wrench Size	Cut-Off (C)	Length (L)	in.	mm	in.	mm
UC-NPF-0402	36600-0402	20638492	1/4	1/8-27	9/16	14	0.88	22.4	1.86	47.3	
UC-NPF-0404	36600-0404	20242660	1/4	1/4-18	3/4	19	1.09	27.6	2.07	52.5	
UC-NPF-0606	36600-0606	20242656	3/8	3/8-18	7/8	22	1.15	29.2	2.20	55.8	
UC-NPF-0706	36600-0706	20979918	13/32	3/8-18	7/8	22	1.15	29.2	2.20	55.8	
UC-NPF-0808	36600-0808	20242622	1/2	1/2-14	1	25	1.40	35.6	2.65	67.2	
UC-NPF-1212	36600-1212	20242548	3/4	3/4-14	1 1/4	32	1.51	38.4	3.06	77.8	



Download the **MyCrimp App** for more information.

Section 5
UC Fittings

FITTINGS



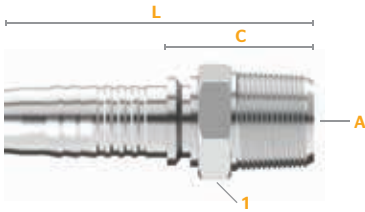

NPTF

Male



Part Number	Product Number	SAP Number	Hose ID	Thread Size (A)	Hex 1 Wrench Size		Cut-Off (C)		Length (L)	
					in.	mm	in.	mm	in.	mm
UC-NPM-0302	36615-0302	20242703	3/16	1/8-27	1/2	12	0.78	19.7	1.65	41.9
UC-NPM-0402	36615-0402	20242766	1/4	1/8-27	9/16	14	0.84	21.2	1.82	46.1
UC-NPM-0404	36615-0404	20242780	1/4	1/4-18	11/16	17	1.06	27.0	2.04	51.9
UC-NPM-0404S	36615-0404S	20540691	1/4	1/4-18	11/16	17	1.06	27.0	2.04	51.9
UC-NPM-0406	36615-0406	20242748	1/4	3/8-18	3/4	19	1.09	27.7	2.07	52.6
UC-NPM-0408	36615-0408	20242661	1/4	1/2-14	7/8	22	1.27	32.2	2.25	57.1
UC-NPM-0504	36615-0504	20283392	5/16	1/4-18	11/16	17	1.07	27.1	2.05	52.0
UC-NPM-0504S	36615-0504S	20540692	5/16	1/4-18	11/16	17	1.07	27.1	2.05	52.0
UC-NPM-0506	36615-0506	20283396	5/16	3/8-18	3/4	19	1.10	27.9	2.08	52.8
UC-NPM-0508	36615-0508	20592578	5/16	1/2-14	7/8	22	1.27	32.3	2.25	57.2
UC-NPM-0604	36615-0604	20242761	3/8	1/4-18	11/16	17	1.07	27.2	2.12	53.8
UC-NPM-0606	36615-0606	20242782	3/8	3/8-18	3/4	19	1.10	27.9	2.15	54.6
UC-NPM-0606S	36615-0606S	20540693	3/8	3/8-18	3/4	19	1.10	27.9	2.15	54.6
UC-NPM-0608	36615-0608	20242767	3/8	1/2-14	7/8	22	1.27	32.4	2.32	59.0
UC-NPM-0704	36615-0704	20979896	13/32	1/4-18	11/16	17	1.07	27.2	2.12	53.8
UC-NPM-0706	36615-0706	20979897	13/32	3/8-18	3/4	19	1.10	27.9	2.15	54.6
UC-NPM-0708	36615-0708	20979898	13/32	1/2-14	7/8	22	1.27	32.4	2.32	59.0
UC-NPM-0806	36615-0806	20242722	1/2	3/8-18	3/4	19	1.12	28.4	2.37	60.1
UC-NPM-0808	36615-0808	20242775	1/2	1/2-14	7/8	22	1.30	33.0	2.55	64.7
UC-NPM-0808S	36615-0808S	20540694	1/2	1/2-14	7/8	22	1.30	33.0	2.55	64.7
UC-NPM-0812	36615-0812	20242679	1/2	3/4-14	1 1/16	27	1.34	34.1	2.59	65.8
UC-NPM-1012	36615-1012	20274105	5/8	3/4-14	1 1/16	27	1.35	34.4	2.71	68.9
UC-NPM-1208	36615-1208	20242689	3/4	1/2-14	1 1/16	27	1.32	33.5	2.87	73.0
UC-NPM-1212	36615-1212	20242771	3/4	3/4-14	1 1/16	27	1.36	34.6	2.92	74.1
UC-NPM-1212S	36615-1212S	20540695	3/4	3/4-14	1 1/16	27	1.36	34.6	2.92	74.1
UC-NPM-1216	36615-1216	20242649	3/4	1-11 1/2	1 1/16	36	1.72	43.7	3.27	83.1
UC-NPM-1416	36615-1416	20269531	7/8	1-11 1/2	1 1/16	36	1.73	43.9	3.27	83.1
UC-NPM-1612	36615-1612	20242684	1	3/4-14	1 1/16	36	1.56	39.5	3.33	84.6
UC-NPM-1616	36615-1616	20242769	1	1-11 1/2	1 1/16	36	1.73	43.9	3.51	89.0
UC-NPM-1616S	36615-1616S	20540696	1	1-11 1/2	1 1/16	36	1.73	43.9	3.51	89.0
UC-NPM-1620	36615-1620	20242638	1	1 1/4-11 1/2	1 3/16	46	1.88	47.8	3.66	92.8
UC-NPM-1820	36615-1820	20283394	1 1/8	1 1/4-11 1/2	1 3/16	46	1.89	48.0	3.65	92.6

Continued on the next page.

FITTINGS



Section 5

UC Fittings

COMPATIBLE HOSE:

- | | | | | |
|-------|-----|-------|------|------|
| SR1SN | SR5 | HR6 | SFS | ACP3 |
| SR2SN | DR5 | HR4 | SCP3 | BOP |
| SR3 | SR6 | SR14A | | |

For a detailed list, please refer to your Crimp Specifications Manual.

NPTF (Male) Continued

Part Number	Product Number	SAP Number	Hose ID	Thread Size (A)	Hex 1 Wrench Size		Cut-Off (C)		Length (L)	
			in.		in.	mm	in.	mm	in.	mm
UC-NPM-2020	36615-2020	20242773	1 ¼	1 ¼-11 ½	1 ⅞	46	1.95	49.5	4.00	101.5
UC-NPM-2224	36615-2224	20283393	1 ⅜	1 ½-11 ½	2	50	1.99	50.6	4.04	102.6
UC-NPM-2424	36615-2424	20242685	1 ½	1 ½-11 ½	2	50	2.01	51.0	4.34	110.1
UC-NPM-2424S	36615-2424S	20873147	1 ½	1 ½-11 ½	2	50	2.01	51.0	4.34	110.1
UC-NPM-2432S	36615-2424	20873148	1 ½	2-11 ½	2 ⅞	65	2.14	54.4	4.98	126.5
UC-NPM-2932	36615-2932	20269535	1 ⅞	2-11 ½	2 ⅞	65	2.14	54.4	4.98	126.5
UC-NPM-3232	36615-3232	20242642	2	2-11 ½	2 ⅞	65	2.14	54.5	4.98	126.4

S=Stainless Steel (See Fitting Identification in Appendix for more information.)

NPTF

Male / Swivel

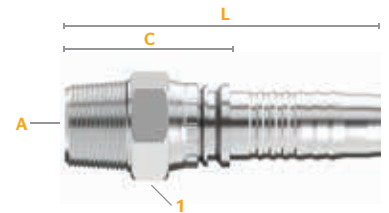

Part Number	Product Number	SAP Number	Hose ID	Thread Size (A)	Hex 1 Wrench Size		Cut-Off (C)		Length (L)	
			in.		in.	mm	in.	mm	in.	mm
UC-NPMX-0404	36645-0404	20242757	1/4	1/4-18	11/16	17	1.49	37.8	2.47	62.7
UC-NPMX-0404S	36645-0404S	20879001	1/4	1/4-18	11/16	17	1.49	37.8	2.47	62.7
UC-NPMX-0406	36645-0406	20242519	1/4	3/8-18	7/8	22	1.57	39.9	2.55	64.8
UC-NPMX-0604	36645-0604	20242745	3/8	1/4-18	11/16	17	1.58	40.1	2.63	66.8
UC-NPMX-0606	36645-0606	20242777	3/8	3/8-18	7/8	22	1.49	37.8	2.54	64.4
UC-NPMX-0606S	36645-0606S	20879002	3/8	3/8-18	7/8	22	1.49	37.8	2.54	64.4
UC-NPMX-0608	36645-0608	20242751	3/8	1/2-14	1	25	1.71	43.5	2.76	70.2
UC-NPMX-0704	36645-0704	20979919	13/32	1/4-18	11/16	17	1.62	41.1	2.67	67.8
UC-NPMX-0706	36645-0706	20979920	13/32	3/8-18	7/8	22	1.53	38.8	2.58	65.5
UC-NPMX-0708	36645-0708	20979921	13/32	1/2-14	1	25	1.71	43.5	2.76	70.2
UC-NPMX-0806	36645-0806	20242503	1/2	3/8-18	7/8	22	1.51	38.5	2.76	70.1
UC-NPMX-0808	36645-0808	20242762	1/2	1/2-14	1	25	1.66	42.3	2.91	73.9
UC-NPMX-0808S	36645-0808S	20879003	1/2	1/2-14	1	25	1.66	42.3	2.91	73.9
UC-NPMX-1212	36645-1212	20242730	3/4	3/4-14	1 ¼	32	1.97	50.1	3.53	89.6
UC-NPMX-1212S	36645-1212S	20879004	3/4	3/4-14	1 ¼	32	1.97	50.1	3.53	89.6
UC-NPMX-1616	36645-1616	20242739	1	1-11 ½	1 ⅞	41	2.30	58.4	4.07	103.5
UC-NPMX-1616S	36645-1616S	20879005	1	1-11 ½	1 ⅞	41	2.30	58.4	4.07	103.5

S=Stainless Steel (See Fitting Identification in Appendix for more information.)



Download the **MyCrimp App** for more information.

Section 5
UC Fittings

FITTINGS



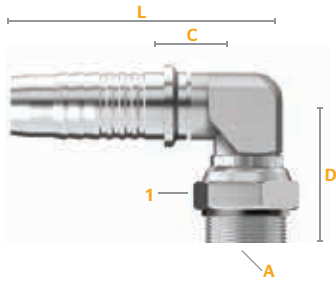

NPTF

Male / 90° Block Elbow / Swivel



Part Number	Product Number	SAP Number	Thread Size (A)		Hex 1 Wrench Size		Drop (D)		Cut-Off (C)		Length (L)	
			Hose ID	in.	mm	in.	mm	in.	mm	in.	mm	
UC-NPMX90B-0404	36650-0404	20318350	1/4	1/4-18	11/16	17	1.69	42.9	0.71	18.1	1.69	43.0
UC-NPMX90B-0604	36650-0604	20318351	3/8	1/4-18	11/16	17	1.63	41.5	0.92	23.3	1.97	50.0
UC-NPMX90B-0606	36650-0606	20318352	3/8	3/8-18	7/8	22	1.62	41.2	0.92	23.3	1.97	50.0
UC-NPMX90B-0808	36650-0808	20318353	1/2	1/2-14	1	25	2.15	54.6	1.16	29.4	2.41	61.1
UC-NPMX90B-1212	36650-1212	20318364	3/4	3/4-14	1 1/4	32	2.58	65.6	1.24	31.5	2.80	71.0

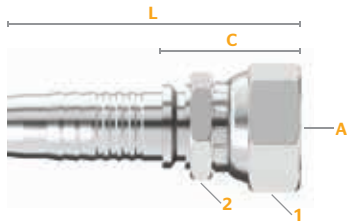

NPSM

Female / Swivel

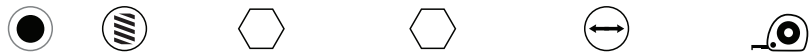

Part Number	Product Number	SAP Number	Thread Size (A)		Hex 1 Wrench Size		Hex 2 Wrench Size		Cut-Off (C)		Length (L)	
			Hose ID	in.	mm	in.	mm	in.	mm	in.	mm	
UC-NSFX-0404	36655-0404	20242668	1/4	1/4-18	3/4	19	11/16	17	1.19	30.2	2.17	55.1
UC-NSFX-0606	36655-0606	20242669	3/8	3/8-18	7/8	22	3/4	19	1.24	31.4	2.29	58.0
UC-NSFX-0706	36655-0706	20979922	13/32	3/8-18	7/8	22	3/4	19	1.24	31.4	2.29	58.0
UC-NSFX-0808	36655-0808	20242654	1/2	1/2-14	1 1/16	27	7/8	22	1.35	34.3	2.60	66.0
UC-NSFX-1212S	36655-1212S	20955326	3/4	3/4-14	1 1/4	32	1 3/16	30	1.46	37.1	3.01	76.5
UC-NSFX-1616S	36655-1616S	20955327	1	1-11 1/2	1 1/2	38	1 3/16	36	1.76	44.7	3.54	89.9

S=Stainless Steel (See Fitting Identification in Appendix for more information.)

FITTINGS



Section 5

UC Fittings

COMPATIBLE HOSE:





SR1SN	SR5	HR6	SFS	ACP3
SR2SN	DR5	HR4	SCP3	BOP
SR3	SR6	SR14A		

For a detailed list, please refer to your Crimp Specifications Manual.

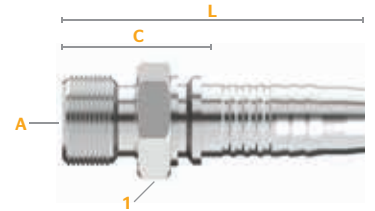
SAE J514 Flareless Tube Fittings

Male





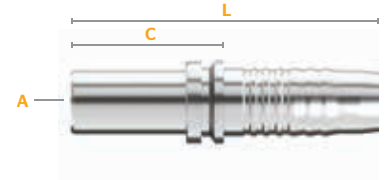

Part Number	Product Number	SAP Number								
			Hose ID	Thread Size (A)	Hex 1 Wrench Size		Cut-Off (C)		Length (L)	
			in.		in.	mm	in.	mm	in.	mm
UC-FTM-0404	36360-0404	20286107	1/4	7/16-20	1/2	12	0.88	22.2	1.86	47.1
UC-FTM-0506	36360-0506	20295568	5/16	9/16-18	5/8	16	0.97	24.7	1.95	49.6
UC-FTM-0606	36360-0606	20286108	3/8	9/16-18	5/8	16	0.97	24.7	2.02	51.4

All fittings come with nut and sleeve.

Standpipe



Part Number	Product Number	SAP Number						
			Hose ID	Tube OD (A)	Cut-Off (C)		Length (L)	
			in.	mm	in.	mm	in.	mm
UC-SP-0408	36825-0408	20242506	1/4	8	1.19	30.3	2.17	55.2
UC-SP-0410	36825-0410	20242461	1/4	10	1.27	32.3	2.25	57.2
UC-SP-0610	36825-0610	20242555	3/8	10	1.19	30.2	2.24	56.9
UC-SP-0612	36825-0612	20242576	3/8	12	1.15	29.2	2.20	55.9
UC-SP-0815	36825-0815	20242372	1/2	15	1.26	32.0	2.51	63.7
UC-SP-0816	36825-0816	20242482	1/2	16	1.46	37.1	2.71	68.8
UC-SP-1222	36825-1222	20242373	3/4	22	1.44	36.6	2.99	76.0
UC-SP-1628	36825-1628	20242371	1	28	1.59	40.4	3.37	85.5



Download the **MyCrimp App** for more information.

Section 5
UC Fittings

FITTINGS



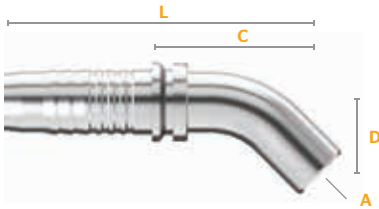

Standpipe

45° Elbow



Part Number	Product Number	SAP Number	Hose ID		Drop (D)		Cut-Off (C)		Length (L)	
			in.	mm	in.	mm	in.	mm	in.	mm
UC-SP45-0408	36830-0408	20242370	1/4	8	0.91	23.1	1.69	42.9	2.67	67.8

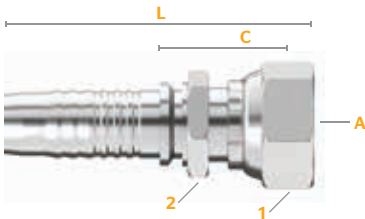

O-Ring Face Seal (SAE J1453 ORS/ORFS)

Female / Swivel

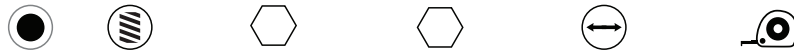

Part Number	Product Number	SAP Number	Hose ID	Thread Size (A)		Hex 1 Wrench Size		Hex 2 Wrench Size		Cut-Off (C)		Length (L)	
				in.	mm	in.	mm	in.	mm	in.	mm	in.	mm
UC-OFFX-0404	36700-0404	20242723	1/4	9/16-18	11/16	17	9/16	14	1.07	27.3	2.05	52.2	
UC-OFFX-0406	36700-0406	20242655	1/4	11/16-16	7/8	22	11/16	17	1.19	30.1	2.17	55.0	
UC-OFFX-0408	36700-0408	20242441	1/4	13/16-16	15/16	24	7/8	22	1.39	35.4	2.37	60.3	
UC-OFFX-0506	36700-0506	20242544	5/16	11/16-16	7/8	22	11/16	17	1.19	30.2	2.17	55.1	
UC-OFFX-0604	36700-0604	20612477	3/8	9/16-18	11/16	17	11/16	17	1.12	28.4	2.17	55.1	
UC-OFFX-0606	36700-0606	20242763	3/8	11/16-16	7/8	22	11/16	17	1.19	30.3	2.24	56.9	
UC-OFFX-0608	36700-0608	20242691	3/8	13/16-16	15/16	24	7/8	22	1.40	35.6	2.45	62.2	
UC-OFFX-0706	36700-0706	20979926	13/32	11/16-16	7/8	22	11/16	17	1.19	30.3	2.24	56.9	
UC-OFFX-0708	36700-0708	20979927	13/32	13/16-16	15/16	24	7/8	22	1.40	35.6	2.45	62.2	
UC-OFFX-0806	36700-0806	20242552	1/2	11/16-16	7/8	22	3/4	19	1.26	32.0	2.51	63.7	
UC-OFFX-0808	36700-0808	20242733	1/2	13/16-16	15/16	24	7/8	22	1.42	36.1	2.67	67.8	
UC-OFFX-0808S	36700-0808S	20838430	1/2	13/16-16	15/16	24	7/8	22	1.42	36.1	2.67	67.8	
UC-OFFX-0810	36700-0810	20242704	1/2	1-14	1 3/8	30	15/16	24	1.56	39.5	2.80	71.2	
UC-OFFX-0812	36700-0812	20242551	1/2	1 3/8-12	1 7/8	36	1 3/8	30	1.66	42.1	2.90	73.8	
UC-OFFX-1010	36700-1010	20242442	5/8	1-14	1 3/8	30	15/16	24	1.56	39.6	2.92	74.1	
UC-OFFX-1012	36700-1012	20242367	5/8	1 3/8-12	1 7/8	36	1 3/8	30	1.66	42.1	3.10	78.8	
UC-OFFX-1210	36700-1210	20242553	3/4	1-14	1 3/8	30	1 3/8	27	1.58	40.1	3.13	79.5	
UC-OFFX-1212	36700-1212	20242741	3/4	1 3/8-12	1 7/8	36	1 3/8	30	1.67	42.3	3.22	81.8	
UC-OFFX-1216	36700-1216	20242646	3/4	1 3/8-12	1 7/8	41	1 3/8	36	1.92	48.6	3.47	88.1	

Continued on the next page.

FITTINGS



Section 5

UC Fittings

COMPATIBLE HOSE:

SR1SN	SR5	HR6	SFS	ACP3
SR2SN	DR5	HR4	SCP3	BOP
SR3	SR6	SR14A		

For a detailed list, please refer to your Crimp Specifications Manual.

O-Ring Face Seal (Female) Continued

Part Number	Product Number	SAP Number	Hose ID	Thread Size (A)	Hex 1 Wrench Size		Hex 2 Wrench Size		Cut-Off (C)		Length (L)	
					in.	mm	in.	mm	in.	mm	in.	mm
UC-OFFX-1612	36700-1612	20242521	1	1 7/16 -12	1 7/16	36	1 1/4	32	1.79	45.3	3.56	90.4
UC-OFFX-1616	36700-1616	20242734	1	1 7/16 -12	1 5/8	41	1 7/16	36	1.95	49.4	3.72	94.5
UC-OFFX-1616S	36700-1616S	20838431	1	1 7/16 -12	1 5/8	41	1 7/16	36	1.95	49.4	3.72	94.5
UC-OFFX-1620	36700-1620	20242505	1	1 7/16 -12	2	50	1 5/8	41	1.98	50.3	3.76	95.4
UC-OFFX-2020	36700-2020	20242692	1 1/4	1 1/8 -12	2	50	1 5/8	41	2.08	52.9	4.13	104.9
UC-OFFX-2424	36700-2424	20242495	1 1/2	2-12	2 3/8	60	2	50	2.23	56.7	4.56	115.8
UC-OFFX-2424S	36700-2424S	20838432	1 1/2	2-12	2 3/8	60	2	50	2.23	56.7	4.56	115.8

S=Stainless Steel (See Fitting Identification in Appendix for more information.)

O-Ring Face Seal (SAE J1453 ORS/ORFS)

Female / 45° Elbow / Swivel

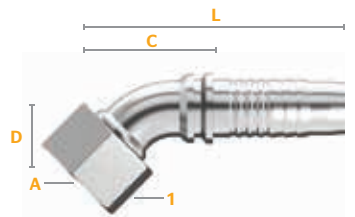

Part Number	Product Number	SAP Number	Hose ID	Thread Size (A)	Hex 1 Wrench Size		Drop (D)		Cut-Off (C)		Length (L)	
					in.	mm	in.	mm	in.	mm	in.	mm
UC-OFFX45-0404	36710-0404	20242631	1/4	9/16-18	11/16	17	0.43	10.9	1.61	41.0	2.60	66.0
UC-OFFX45-0406	36710-0406	20242549	1/4	11/16-16	7/8	22	0.43	10.9	1.81	46.0	2.80	71.0
UC-OFFX45-0506	36710-0506	20242456	5/16	11/16-16	7/8	22	0.47	11.9	1.81	46.0	2.99	76.0
UC-OFFX45-0606	36710-0606	20242683	3/8	11/16-16	7/8	22	0.47	11.9	1.85	47.0	2.91	74.0
UC-OFFX45-0608	36710-0608	20242593	3/8	13/16-16	15/16	24	0.59	15.0	2.01	51.0	3.07	78.0
UC-OFFX45-0706	36710-0706	20979928	13/32	11/16-16	7/8	22	0.47	11.9	1.85	47.0	2.90	73.7
UC-OFFX45-0708	36710-0708	20979929	13/32	13/16-16	15/16	24	0.59	15.0	2.01	51.0	3.06	77.6
UC-OFFX45-0808 ^c	36710-0808	20242637	1/2	13/16-16	15/16	24	0.63	16.0	1.85	47.0	3.11	79.0
UC-OFFX45-0810	36710-0810	20242532	1/2	1-14	1 3/8	30	0.65	16.5	1.97	50.0	3.23	82.0
UC-OFFX45-1212	36710-1212	20242681	3/4	1 3/16 -12	1 7/16	36	0.83	21.0	2.48	63.0	4.06	103.0
UC-OFFX45-1216	36710-1216	20242359	3/4	1 7/16 -12	1 5/8	41	0.94	23.9	2.80	71.1	4.33	110.0
UC-OFFX45-1616	36710-1616	20242643	1	1 7/16 -12	1 5/8	41	1.02	26.0	3.23	81.9	5.00	127.0
UC-OFFX45-1620	36710-1620	20242355	1	1 1/8 -12	2	50	1.02	25.9	3.35	85.1	5.41	137.5
UC-OFFX45-2020	36710-2020	20242609	1 1/4	1 1/8 -12	2	50	1.02	25.9	3.82	97.0	6.16	156.5
UC-OFFX45-2024	36710-2024	20242477	1 1/4	2-12	2 3/8	60	1.10	27.9	3.98	101.1	6.34	161.0
UC-OFFX45-2424	36710-2424	20242357	1 1/2	2-12	2 3/8	60	1.10	27.9	4.13	104.9	6.77	172.0

C=Crimp Nut (See Fitting Identification in Appendix for more information.)



Download the **MyCrimp App** for more information.

Section 5
UC Fittings

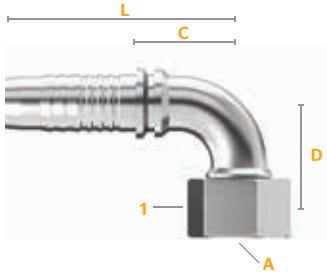

O-Ring Face Seal (SAE J1453 ORS/ORFS)

Female / 90° Elbow / Swivel



Part Number	Product Number	SAP Number	Hose ID	Thread Size (A)	Hex 1 Wrench Size	Elbow Type*	Drop (D)		Cut-Off (C)		Length (L)	
			in.	in.	in.		mm	in.	mm	in.	mm	in.
UC-OFFX90-0404	36715-0404	20242602	1/4	9/16-18	11/16		1.26	32.0	1.18	30.0	2.16	54.9
UC-OFFX90L-0404	36720-0404	20242533	1/4	9/16-18	11/16	LT	1.81	46.0	1.30	33.0	2.28	57.9
UC-OFFX90S-0404	36725-0404	20242682	1/4	9/16-18	11/16	ST	0.83	21.0	1.10	28.0	2.08	52.9
UC-OFFX90-0406	36715-0406	20242479	1/4	11/16-16	7/8		1.50	38.0	1.46	37.0	2.44	61.9
UC-OFFX90L-0406	36720-0406	20242492	1/4	11/16-16	7/8	LT	2.13	54.0	1.38	35.0	2.36	59.9
UC-OFFX90S-0406	36725-0406	20242598	1/4	11/16-16	7/8	ST	0.91	23.0	1.26	32.0	2.24	56.9
UC-OFFX90S-0506	36725-0506	20242494	5/16	11/16-16	7/8	ST	0.98	24.9	1.61	40.9	2.59	65.8
UC-OFFX90-0606	36715-0606	20242633	3/8	11/16-16	7/8		1.50	38.0	1.65	42.0	2.70	68.6
UC-OFFX90L-0606	36720-0606	20242615	3/8	11/16-16	7/8	LT	2.13	54.0	1.65	42.0	2.70	68.6
UC-OFFX90S-0606	36725-0606	20242717	3/8	11/16-16	7/8	ST	0.98	25.0	1.65	42.0	2.70	68.6
UC-OFFX90-0608	36715-0608	20242480	3/8	13/16-16	15/16		1.61	41.0	1.73	44.0	2.78	70.6
UC-OFFX90L-0608	36720-0608	20242493	3/8	13/16-16	15/16	LT	2.52	64.0	1.85	47.0	2.90	73.6
UC-OFFX90S-0608	36725-0608	20242620	3/8	13/16-16	15/16	ST	1.14	29.0	1.65	42.0	2.70	68.6
UC-OFFX90-0706	36715-0706	20979930	13/32	11/16-16	7/8		1.50	38.0	1.65	42.0	2.70	68.6
UC-OFFX90S-0706	36725-0706	20979932	13/32	11/16-16	7/8	ST	0.98	25.0	1.65	42.0	2.70	68.6
UC-OFFX90-0708	36715-0708	20979931	13/32	13/16-16	15/16		1.61	41.0	1.73	44.0	2.781	70.6
UC-OFFX90S-0708	36725-0708	20979933	13/32	13/16-16	15/16	ST	1.14	29.0	1.65	42.0	2.70	68.6
UC-OFFX90-0808 ^c	36715-0808	20242571	1/2	13/16-16	15/16		1.65	42.0	1.38	35.0	2.63	66.7
UC-OFFX90L-0808 ^c	36720-0808	20242566	1/2	13/16-16	15/16	LT	2.52	64.0	1.50	38.0	2.74	69.7
UC-OFFX90S-0808 ^c	36725-0808	20242663	1/2	13/16-16	15/16	ST	1.14	29.0	1.58	40.0	2.82	71.7
UC-OFFX90-0810	36715-0810	20242363	1/2	1-14	1 3/16		1.85	47.0	1.89	48.0	3.14	79.7
UC-OFFX90L-0810	36720-0810	20242438	1/2	1-14	1 3/16	LT	2.76	70.1	1.81	46.0	3.06	77.6
UC-OFFX90S-0810	36725-0810	20242550	1/2	1-14	1 3/16	ST	1.28	32.5	1.81	46.0	3.06	77.6
UC-OFFX90S-0812	36725-0812	20318321	1/2	1 3/16-12	1 7/16	ST	2.01	51.1	2.19	55.6	3.44	87.3
UC-OFFX90-1010	36715-1010	20242403	5/8	1-14	1 3/16		1.73	44.0	2.17	55.0	3.52	89.5
UC-OFFX90S-1010	36725-1010	20242365	5/8	1-14	1 3/16	ST	1.28	32.5	2.05	52.0	3.40	86.5
UC-OFFX90S-1012	36725-1012	20242364	5/8	1 3/16-12	1 7/16	ST	1.93	49.0	2.17	55.1	3.53	89.6
UC-OFFX90S-1210	36725-1210	20242457	3/4	1-14	1 3/16	ST	1.54	39.1	1.75	44.5	3.30	83.9
UC-OFFX90-1212	36715-1212	20242439	3/4	1 3/16-12	1 7/16		2.28	58.0	2.44	62.0	3.99	101.4
UC-OFFX90L-1212	36720-1212	20242514	3/4	1 3/16-12	1 7/16	LT	3.78	96.0	2.44	62.0	3.99	101.4
UC-OFFX90S-1212	36725-1212	20242680	3/4	1 3/16-12	1 7/16	ST	2.01	51.0	2.40	61.0	3.96	100.5
UC-OFFX90S-1216	36725-1216	20242481	3/4	1 7/16-12	1 5/8	ST	2.80	71.1	2.60	66.0	4.15	105.5

Continued on the next page.

FITTINGS



Section 5

UC Fittings

COMPATIBLE HOSE:

SR1SN	SR5	HR6	SFS	ACP3
SR2SN	DR5	HR4	SCP3	BOP
SR3	SR6	SR14A		

For a detailed list, please refer to your Crimp Specifications Manual.

O-Ring Face Seal (Female 90° Elbow) Continued

Part Number	Product Number	SAP Number	Hose ID	Thread	Hex 1		Elbow Type*	Drop (D)		Cut-Off (C)		Length (L)	
				Size (A)	Wrench Size	in.		mm	in.	mm	in.	mm	in.
UC-OFFX90-1616	36715-1616	20242478	1	1 1/16-12	1 3/8	41		2.60	66.0	3.27	83.0	5.04	128.1
UC-OFFX90L-1616	36720-1616	20242504	1	1 1/16-12	1 3/8	41	LT	4.49	114.0	3.27	83.0	5.04	128.1
UC-OFFX90S-1616	36725-1616	20242690	1	1 1/16-12	1 3/8	41	ST	2.28	58.0	3.27	83.0	5.04	128.1
UC-OFFX90-1620	36715-1620	20242360	1	1 1/16-12	2	50		3.07	78.0	3.27	83.0	5.04	128.1
UC-OFFX90S-1620	36725-1620	20242440	1	1 1/16-12	2	50	ST	2.52	64.0	3.27	83.0	5.04	128.1
UC-OFFX90S-2020	36725-2020	20242671	1 1/4	1 1/16-12	2	50	ST	2.68	68.1	3.74	95.0	5.79	147.0
UC-OFFX90L-2024	36720-2024	20242402	1 1/4	2-12	2 3/8	60	LT	5.55	141.0	4.02	102.1	6.07	154.1
UC-OFFX90S-2024	36725-2024	20242405	1 1/4	2-12	2 3/8	60	ST	2.72	69.1	4.02	102.1	6.07	154.1
UC-OFFX90S-2424	36725-2424	20242404	1 1/2	2-12	2 3/8	60	ST	3.07	78.0	4.02	102.1	6.35	161.2

C=Crimp Nut (See Fitting Identification in Appendix for more information.) *Elbow Type: LT=Long Tube ST=Short Tube

O-Ring Face Seal (SAE J1453 ORS/ORFS)

Male

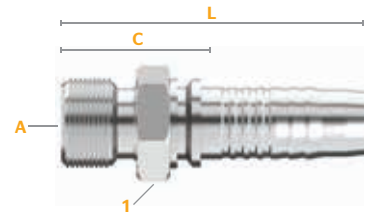

Part Number	Product Number	SAP Number	Hose ID	Thread	Hex 1		Cut-Off (C)		Length (L)	
			in.	in.	in.	mm	in.	mm	in.	mm
UC-OFM-0404	36730-0404	20242567	1/4	9/16-18	11/16	17	1.00	25.4	1.98	50.3
UC-OFM-0406	36730-0406	20777952	1/4	11/16-16	3/4	19	0.96	24.3	1.94	49.1
UC-OFM-0506	36730-0506	20959268	5/16	11/16-16	3/4	19	1.05	26.7	2.03	51.6
UC-OFM-0606	36730-0606	20242596	3/8	11/16-16	3/4	19	1.05	26.7	2.10	53.4
UC-OFM-0608	36730-0608	20242575	3/8	13/16-16	7/8	22	1.05	26.6	2.10	53.2
UC-OFM-0706	36730-0706	20979934	13/32	11/16-16	3/4	19	1.06	26.9	2.11	53.6
UC-OFM-0708	36730-0708	20979935	13/32	13/16-16	7/8	22	1.05	26.6	2.10	53.2
UC-OFM-0808	36730-0808	20242545	1/2	13/16-16	7/8	22	1.19	30.3	2.44	62.0
UC-OFM-0810	36730-0810	20242369	1/2	1-14	1 1/16	27	1.21	30.7	2.46	62.4
UC-OFM-0812	36730-0812	20242368	1/2	1 3/16-12	1 1/4	32	1.34	34.0	2.59	65.7
UC-OFM-1212	36730-1212	20242535	3/4	1 3/16-12	1 1/4	32	1.36	34.6	2.92	74.1
UC-OFM-1216	36730-1216	20242443	3/4	1 7/16-12	1 3/8	41	1.55	39.3	3.10	78.8
UC-OFM-1616	36730-1616	20242459	1	1 1/16-12	1 1/2	38	1.47	37.4	3.25	82.5
UC-OFM-2020	36730-2020	20242460	1 1/4	1 1/16-12	1 3/8	46	1.64	41.7	3.69	93.7



Download the **MyCrimp App** for more information.

Section 5
UC Fittings

FITTINGS



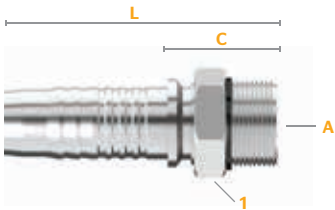

O-Ring Boss Straight Thread (SAE J514)

Male



Part Number	Product Number	SAP Number	Hose ID		Thread Size (A)		Hex 1 Wrench Size		Cut-Off (C)		Length (L)	
			in.	mm	in.	mm	in.	mm	in.	mm	in.	mm
UC-OBM-0404	36670-0404	20242597	1/4		7/16-20		9/16	14	0.88	22.3	1.86	47.2
UC-OBM-0405	36670-0405	20242531	1/4		1/2-20		5/8	16	0.88	22.3	1.86	47.2
UC-OBM-0406	36670-0406	20242591	1/4		9/16-18		11/16	17	0.88	22.2	1.86	47.1
UC-OBM-0606	36670-0606	20242677	3/8		9/16-18		3/4	19	0.94	23.7	1.98	50.4
UC-OBM-0608	36670-0608	20242672	3/8		3/4-16		7/8	22	0.987	25.1	2.036	51.8
UC-OBM-0610	36670-0610	20242614	3/8		7/8-14		1 1/8	27	1.08	27.4	2.13	54.1
UC-OBM-0706	36670-0706	20979923	13/32		9/16-18		3/4	19	0.94	23.7	1.98	50.4
UC-OBM-0708	36670-0708	20979924	13/32		3/4-16		7/8	22	0.987	25.1	2.036	51.8
UC-OBM-0710	36670-0710	20979925	13/32		7/8-14		1 1/8	27	1.079	27.4	2.128	54.1
UC-OBM-0808	36670-0808	20242665	1/2		3/4-16		7/8	22	1.01	25.6	2.26	57.3
UC-OBM-0810	36670-0810	20242595	1/2		7/8-14		1 1/8	27	1.10	27.9	2.35	59.6
UC-OBM-0812	36670-0812	20242476	1/2		1 1/8-12		1 1/4	32	1.26	32.1	2.51	63.8
UC-OBM-1210	36670-1210	20242520	3/4		7/8-14		1 1/8	27	1.13	28.6	2.68	68.0
UC-OBM-1212	36670-1212	20242592	3/4		1 1/8-12		1 1/4	32	1.29	32.7	2.84	72.2
UC-OBM-1216	36670-1216	20242455	3/4		1 1/8-12		1 1/2	38	1.37	34.8	2.92	74.2
UC-OBM-1616	36670-1616	20242589	1		1 1/8-12		1 1/2	38	1.38	35.0	3.15	80.1

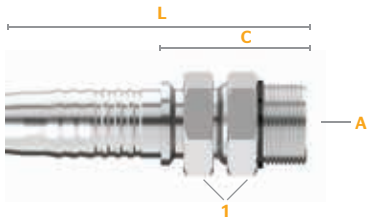

O-Ring Boss Straight Thread (SAE J514)

Male / Swivel



Part Number	Product Number	SAP Number	Hose ID		Thread Size (A)		Hex 1 Wrench Size		Cut-Off (C)		Length (L)	
			in.	mm	in.	mm	in.	mm	in.	mm		
UC-OBMX-0608	36680-0608	20318237	3/8		3/4-16		1	25	1.731	44.0	2.78	70.6
UC-OBMX-0808	36680-0808	20318238	1/2		3/4-16		1	25	1.682	42.7	2.93	74.4
UC-OBMX-0810	36680-0810	20318239	1/2		7/8-14		1	25	1.689	42.9	2.94	74.6

FITTINGS



Section 5

UC Fittings

COMPATIBLE HOSE:





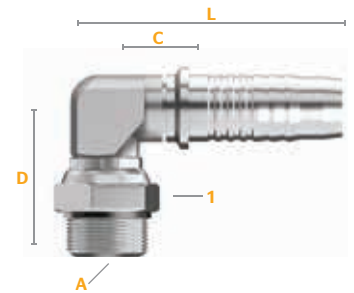

SR1SN	SR5	HR6	SFS	ACP3
SR2SN	DR5	HR4	SCP3	BOP
SR3	SR6	SR14A		

For a detailed list, please refer to your Crimp Specifications Manual.

O-Ring Boss Straight Thread (SAE J514)





Male / 90° Block Elbow / Swivel

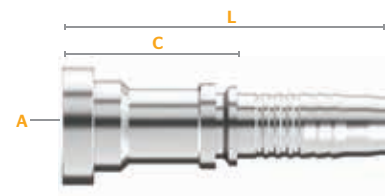

Part Number	Product Number	SAP Number										
			Hose ID	Thread Size (A)	Hex 1 Wrench Size	Drop (D)	Cut-Off (C)	Length (L)	in.	mm	in.	mm
UC-OBMX90B-0405	36685-0405	20318354	1/4	1/2-20	11/16	17	1.48	37.6	0.71	18.1	1.69	43.0
UC-OBMX90B-0606	36685-0606	20318355	3/8	9/16-18	7/8	22	1.74	44.3	0.92	23.3	1.97	50.0
UC-OBMX90B-0608	36685-0608	20318356	3/8	3/4-16	1	25	2.17	55.0	1.13	28.8	2.18	55.4
UC-OBMX90B-0808	36685-0808	20318357	1/2	3/4-16	1	25	2.17	55.0	1.16	29.4	2.41	61.1
UC-OBMX90B-0810	36685-0810	20318358	1/2	7/8-14	1	25	2.17	55.2	1.16	29.4	2.41	61.1
UC-OBMX90B-1212	36685-1212	20318365	1	1 1/8-12	1 1/4	32	2.58	65.5	1.24	31.5	2.80	71.0

Code 61 Flange (SAE J518)



Part Number	Product Number	SAP Number									
			Hose ID	Flange Size	Flange Diameter (A)	Cut-Off (C)	Length (L)	in.	mm	in.	mm
UC-FL-0808	36320-0808	20242569	1/2	1/2	1.19	30.2	1.61	40.9	2.86	72.6	
UC-FL-0812	36320-0812	20242300	1/2	3/4	1.50	38.1	1.65	41.9	2.90	73.6	
UC-FL-1212	36320-1212	20242707	3/4	3/4	1.50	38.1	1.67	42.4	3.22	81.9	
UC-FL-1216	36320-1216	20242650	3/4	1	1.75	44.5	1.99	50.5	3.54	90.0	
UC-FL-1616	36320-1616	20242744	1	1	1.75	44.5	2.02	51.3	3.80	96.4	
UC-FL-1620	36320-1620	20242697	1	1 1/4	2.00	50.8	2.12	53.8	3.90	98.9	
UC-FL-2020	36320-2020	20242750	1 1/4	1 1/4	2.00	50.8	2.19	55.6	4.24	107.6	
UC-FL-2024	36320-2024	20242695	1 1/4	1 1/2	2.37	60.3	2.30	58.4	4.35	110.4	
UC-FL-2424	36320-2424	20242726	1 1/2	1 1/2	2.37	60.3	2.31	58.7	4.64	117.8	
UC-FL-2432	36320-2432	20242605	1 1/2	2	2.81	71.4	2.76	70.1	5.09	129.2	
UC-FL-3232	36320-3232	20242693	2	2	2.81	71.4	2.76	70.1	5.59	142.1	
UC-FL-4040	36320-4040	20242599	2 1/2	2 1/2	3.31	84.1	2.24	56.9	5.49	139.4	



Download the **MyCrimp App** for more information.

Section 5
UC Fittings





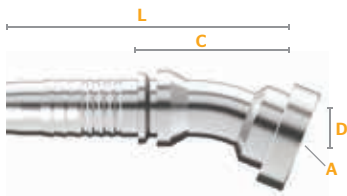

FITTINGS





Code 61 Flange (SAE J518)





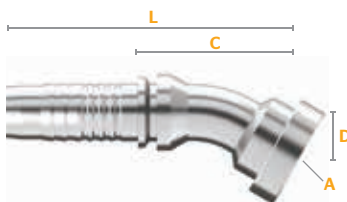

22.5° Elbow

Part Number	Product Number	SAP Number										
			Hose ID	Flange Size	Flange Diameter (A)		Drop (D)		Cut-Off (C)		Length (L)	
			in.		in.	mm	in.	mm	in.	mm	in.	mm
UC-FL22-1616	36330-1616	20242623	1	1	1.75	44.5	0.47	11.9	3.66	93.0	5.44	138.0
UC-FL22-2020	36330-2020	20242568	1 ¼	1 ¼	2.00	50.8	0.63	16.0	4.49	114.0	6.54	166.0
UC-FL22-2424	36330-2424	20242465	1 ½	1 ½	2.37	60.3	0.65	16.5	5.16	131.1	7.49	190.2



Code 61 Flange (SAE J518)





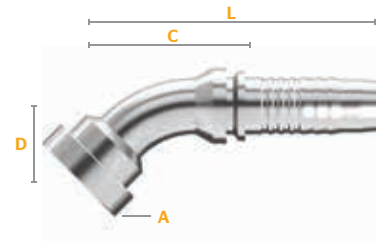

30° Elbow

Part Number	Product Number	SAP Number										
			Hose ID	Flange Size	Flange Diameter (A)		Drop (D)		Cut-Off (C)		Length (L)	
			in.		in.	mm	in.	mm	in.	mm	in.	mm
UC-FL30-1212	36335-1212	20242577	3/4	3/4	1.50	38.1	0.75	19.1	3.19	81.0	4.74	120.5
UC-FL30-1216	36335-1216	20242379	3/4	1	1.75	44.5	0.75	19.1	3.31	84.1	4.86	123.5
UC-FL30-1616	36335-1616	20242497	1	1	1.75	44.5	0.83	21.1	3.54	89.9	5.32	135.0
UC-FL30-1620	36335-1620	20242498	1	1 ¼	2.00	50.8	0.87	22.1	3.54	89.9	5.32	135.0
UC-FL30-2020	36335-2020	20242616	1 ¼	1 ¼	2.00	50.8	0.98	24.9	4.02	102.1	6.07	154.1
UC-FL30-2024	36335-2024	20242378	1 ¼	1 ½	2.37	60.3	1.06	26.9	4.41	112.0	6.46	164.0
UC-FL30-2424	36335-2424	20242582	1 ½	1 ½	2.37	60.3	0.91	23.1	5.35	135.9	7.68	195.0

Code 61 Flange (SAE J518)

45° Elbow







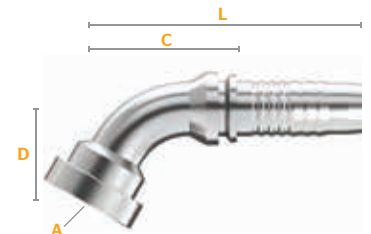

Part Number	Product Number	SAP Number										
			Hose ID	Flange Size	Flange Diameter (A)	Drop (D)	Cut-Off (C)	Length (L)				
			in.		in.	mm	in.	mm	in.	mm	in.	mm
UC-FL45-0808	36340-0808	20242508	1/2	1/2	1.19	30.2	0.87	22.1	2.09	53.1	3.34	84.8
UC-FL45-0812	36340-0812	20242293	1/2	3/4	1.50	38.1	1.02	25.9	2.36	59.9	3.61	91.6
UC-FL45-1212	36340-1212	20242678	3/4	3/4	1.50	38.1	1.26	32.0	2.91	73.9	4.46	113.4
UC-FL45-1216	36340-1216	20242617	3/4	1	1.75	44.5	1.14	29.0	3.07	78.0	4.62	117.4
UC-FL45-1616	36340-1616	20242700	1	1	1.75	44.5	1.32	33.5	3.27	83.1	5.05	128.1
UC-FL45-1620	36340-1620	20242653	1	1 1/4	2.00	50.8	1.42	36.1	3.23	82.0	5.01	127.1
UC-FL45-2020	36340-2020	20242705	1 1/4	1 1/4	2.00	50.8	1.48	37.6	3.74	95.0	5.79	147.0
UC-FL45-2024	36340-2024	20242648	1 1/4	1 1/2	2.37	60.3	1.57	39.9	4.09	103.9	6.14	155.9
UC-FL45-2424	36340-2424	20242686	1 1/2	1 1/2	2.37	60.3	1.89	48.0	4.61	117.1	6.94	176.2
UC-FL45-3232	36340-3232	20242640	2	2	2.81	71.4	1.87	47.5	5.55	141.0	8.38	213.0
UC-FL45-4040	36340-4040	20242509	2 1/2	2 1/2	3.31	84.1	2.09	53.0	5.47	139.0	8.74	222.0

Code 61 Flange (SAE J518)

60° Elbow



Part Number	Product Number	SAP Number										
			Hose ID	Flange Size	Flange Diameter (A)	Drop (D)	Cut-Off (C)	Length (L)				
			in.		in.	mm	in.	mm	in.	mm	in.	mm
UC-FL60-1212	36345-1212	20242516	3/4	3/4	1.50	38.1	1.49	37.8	3.39	86.1	4.94	125.6
UC-FL60-1216	36345-1216	20242499	3/4	1	1.75	44.5	1.73	43.9	4.02	102.1	5.66	143.8
UC-FL60-1616	36345-1616	20242510	1	1	1.75	44.5	1.85	47.0	3.98	101.1	5.76	146.2
UC-FL60-1620	36345-1620	20242560	1	1 1/4	2.00	50.8	1.71	43.4	4.20	106.7	5.98	151.8
UC-FL60-2020	36345-2020	20242523	1 1/4	1 1/4	2.00	50.8	2.22	56.4	5.10	129.5	7.15	181.5
UC-FL60-2424	36345-2424	20242380	1 1/2	1 1/2	2.37	60.3	2.28	57.9	5.31	134.9	7.36	186.8



Download the **MyCrimp App**
for more information.

Section 5
UC Fittings





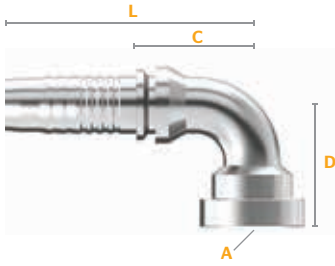

FITTINGS





Code 61 Flange (SAE J518)

90° Elbow

Part Number	Product Number	SAP Number										
			Hose ID	Flange Size	Flange Diameter (A)		Drop (D)		Cut-Off (C)		Length (L)	
			in.		in.	mm	in.	mm	in.	mm	in.	mm
UC-FL90-0808	36350-0808	20242537	1/2	1/2	1.19	30.2	1.65	41.9	1.81	46.0	3.06	77.6
UC-FL90-0812	36350-0812	20242381	1/2	3/4	1.50	38.1	2.01	51.1	1.77	45.0	3.02	76.6
UC-FL90-1212	36350-1212	20242696	3/4	3/4	1.50	38.1	2.36	59.9	2.28	57.9	3.83	97.4
UC-FL90-1216	36350-1216	20242667	3/4	1	1.75	44.5	2.54	64.5	2.60	66.0	4.15	105.5
UC-FL90-1616	36350-1616	20242740	1	1	1.75	44.5	2.64	67.1	2.80	71.1	4.58	116.2
UC-FL90-1620	36350-1620	20242701	1	1 1/4	2.00	50.8	2.80	71.1	2.91	73.9	4.69	119.0
UC-FL90-2016	36350-2016	20242583	1 1/4	1	1.75	44.5	2.56	65.0	3.70	94.0	5.75	145.9
UC-FL90-2020	36350-2020	20242735	1 1/4	1 1/4	2.00	50.8	3.31	84.1	3.46	87.9	5.51	139.9
UC-FL90-2024	36350-2024	20242713	1 1/4	1 1/2	2.37	60.3	3.44	87.4	3.58	90.9	5.63	142.9
UC-FL90-2424	36350-2424	20242714	1 1/2	1 1/2	2.37	60.3	3.58	90.9	4.13	104.9	6.46	164.0
UC-FL90-2432	36350-2432	20242724	1 1/2	2	2.81	71.4	4.53	115.1	4.13	104.9	6.46	164.0
UC-FL90-3224	36350-3224	20588738	2	1 1/2	2.37	60.3	5.24	133.1	5.24	133.1	8.23	209.0
UC-FL90-3232	36350-3232	20242737	2	2	2.81	71.4	5.12	130.0	5.08	129.0	7.91	201.0
UC-FL90-3240	36350-3240	20932839	2	2 1/2	3.31	84.1	5.12	130.0	5.08	129.0	7.91	201.0
UC-FL90-4024	36530-4024	20793532	2 1/2	1 1/2	2.37	60.3	5.06	128.6	5.55	140.9	8.80	223.5
UC-FL90-4032	36530-4032	20793534	2 1/2	2	2.81	71.4	4.19	106.4	5.94	150.9	9.19	233.5
UC-FL90-4040	36350-4040	20245157	2 1/2	2 1/2	3.31	84.1	5.75	146.0	6.30	160.0	9.55	242.5

FITTINGS



Section 5

UC Fittings





COMPATIBLE HOSE:

SR1SN	SR5	HR6	SFS	ACP3
SR2SN	DR5	HR4	SCP3	BOP
SR3	SR6	SR14A		

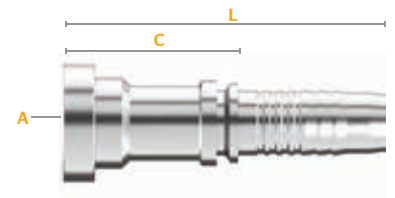
For a detailed list, please refer to your Crimp Specifications Manual.

Code 62 Flange (SAE J518)







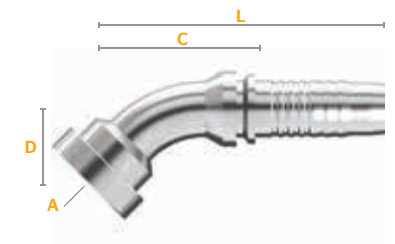

Part Number	Product Number	SAP Number								
			Hose ID	Flange Size	Flange Diameter (A)		Cut-Off (C)		Length (L)	
			in.		in.	mm	in.	mm	in.	mm
UC-FH-1212	36300-1212	20242607	3/4	3/4	1.63	41.3	2.07	52.6	3.62	92.0
UC-FH-1216	36300-1216	20242467	3/4	1	1.87	47.6	2.19	55.5	3.74	95.0
UC-FH-1616	36300-1616	20242647	1	1	1.87	47.6	2.20	55.9	4.00	101.5
UC-FH-1620	36300-1620	20242572	1	1 ¼	2.13	54.0	2.48	62.9	4.25	108.0
UC-FH-2020	36300-2020	20242659	1 ¼	1 ¼	2.13	54.0	3.20	81.3	5.32	135.0
UC-FH-2024	36300-2024	20242419	1 ¼	1 ½	2.50	63.5	2.79	71.0	4.84	122.9
UC-FH-2424	36300-2424	20242601	1 ½	1 ½	2.50	63.5	3.74	95.0	6.07	154.1
UC-FH-3232	36300-3232	20242512	2	2	3.13	79.4	2.99	75.9	5.82	147.9

Code 62 Flange (SAE J518)

45° Elbow



Part Number	Product Number	SAP Number										
			Hose ID	Flange Size	Flange Diameter (A)		Drop (D)	Cut-Off (C)		Length (L)		
			in.		in.	mm	in.	mm	in.	mm	in.	mm
UC-FH45-1212	36310-1212	20242570	3/4	3/4	1.63	41.3	1.22	31.0	3.31	84.1	4.86	123.5
UC-FH45-1616	36310-1616	20242618	1	1	1.87	47.6	1.42	36.1	3.82	97.0	5.60	142.1
UC-FH45-1620	36310-1620	20242527	1	1 ¼	2.13	54.0	1.54	39.1	3.78	96.0	5.65	143.4
UC-FH45-2020	36310-2020	20242600	1 ¼	1 ¼	2.13	54.0	1.57	39.9	4.29	109.0	6.34	160.9
UC-FH45-2424	36310-2424	20242517	1 ½	1 ½	2.50	63.5	1.77	45.0	4.84	122.9	7.17	182.1
UC-FH45-3232	36310-3232	20242383	2	2	3.13	79.4	2.36	59.9	6.18	157.0	9.01	229.0



Download the **MyCrimp App** for more information.

Section 5
UC Fittings





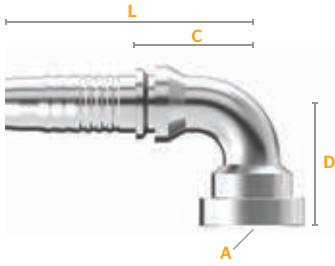

FITTINGS





Code 62 Flange (SAE J518)



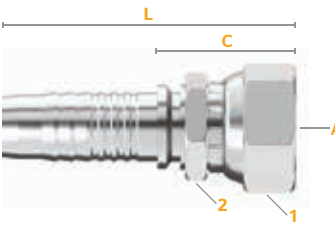

90° Elbow

Part Number	Product Number	SAP Number										
			Hose ID	Flange Size	Flange Diameter (A)		Drop (D)		Cut-Off (C)		Length (L)	
			in.		in.	mm	in.	mm	in.	mm	in.	mm
UC-FH90-0808	36315-0808	20242306	1/2	1/2	1.25	31.8	1.81	46.0	1.89	48.0	3.32	84.3
UC-FH90-1212	36315-1212	20242621	3/4	3/4	1.63	41.3	2.40	61.0	2.48	63.0	4.03	102.4
UC-FH90-1216	36315-1216	20242511	3/4	1	1.87	47.6	2.60	66.0	2.48	63.0	4.03	102.4
UC-FH90-1616	36315-1616	20242673	1	1	1.87	47.6	2.95	74.9	2.91	73.9	4.69	119.0
UC-FH90-1620	36315-1620	20242585	1	1 ¼	2.13	54.0	3.07	78.0	3.07	78.0	4.85	123.1
UC-FH90-2020	36315-2020	20242635	1 ¼	1 ¼	2.13	54.0	3.50	88.9	3.70	94.0	5.75	145.9
UC-FH90-2024	36315-2024	20242418	1 ¼	1 ½	2.50	63.5	3.70	94.0	3.86	98.0	5.91	150.0
UC-FH90-2424	36315-2424	20242578	1 ½	1 ½	2.50	63.5	4.13	104.9	3.94	100.1	6.27	159.2
UC-FH90-3232	36315-3232	20242487	2	2	3.13	79.4	5.20	132.1	5.63	143.0	8.46	215.0



BSPF (British Standard Pipe Parallel)

Female / Swivel

Part Number	Product Number	SAP Number							
			Hose ID	Thread Size (A)	Hex 1 Wrench Size	Cut-Off (C)		Length (L)	
			in.		mm	in.	mm	in.	mm
UC-BPFX-0404	36105-0404	20242738	1/4	1/4-19	19	0.93	23.7	1.91	48.6
UC-BPFX-0406	36105-0406	20242462	1/4	3/8-19	22	1.09	27.6	2.07	52.5
UC-BPFX-0606	36105-0606	20242731	3/8	3/8-19	22	1.09	27.8	2.14	54.4
UC-BPFX-0608	36105-0608	20242557	3/8	1/2-14	27	1.20	30.4	2.24	57.0
UC-BPFX-0706	36105-0706	20979899	13/32	3/8-19	22	1.09	27.8	2.14	54.4
UC-BPFX-0708	36105-0708	20979900	13/32	1/2-14	27	1.20	30.4	2.24	57.0
UC-BPFX-0808	36105-0808	20242715	1/2	1/2-14	27	1.22	31.0	2.47	62.7
UC-BPFX-0810	36105-0810	20242406	1/2	5/8-14	27	1.48	37.6	2.73	69.3
UC-BPFX-1212 ^C	36105-1212	20242626	3/4	3/4-14	32	1.17	29.7	2.72	69.1
UC-BPFX-1616 ^C	36105-1616	20242627	1	1-11	38	1.36	34.4	3.13	79.5
UC-BPFX-2020 ^T	36105-2020	20242483	1 ¼	1 ¼-11	50	1.69	42.8	3.73	94.8
UC-BPFX-2424 ^T	36105-2424	20242806	1 ½	1 ½-11	55	1.80	45.8	4.13	105.0
UC-BPFX-3232	36105-3232	20310550	2	2-11	70	1.98	50.2	4.81	122.2

C=Crimp Nut T=Thrust-Wire Nut (See Fitting Identification in Appendix for more information.)

FITTINGS



Section 5

UC Fittings

COMPATIBLE HOSE:





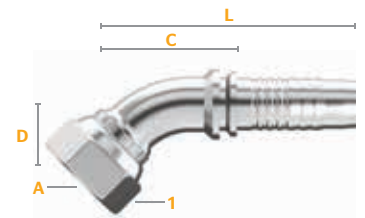

SR1SN	SR5	HR6	SFS	ACP3
SR2SN	DR5	HR4	SCP3	BOP
SR3	SR6	SR14A		

For a detailed list, please refer to your Crimp Specifications Manual.

BSPB (British Standard Pipe Parallel)

Female / 45° Elbow / Swivel







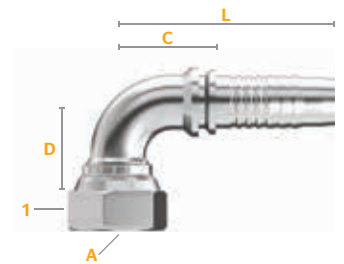

Part Number	Product Number	SAP Number									
			Hose ID	Thread Size (A)	Hex 1 Wrench Size	Drop (D)	Drop (D)	Cut-Off (C)	Cut-Off (C)	Length (L)	Length (L)
			in.		mm	in.	mm	in.	mm	in.	mm
UC-BPFX45-0404	36115-0404	20242444	1/4	1/4-19	19	0.59	15.0	1.81	46.0	2.79	70.9
UC-BPFX45-0606	36115-0606	20242496	3/8	3/8-19	22	0.81	20.6	1.97	50.0	3.02	76.7
UC-BPFX45-0706	36115-0706	20979901	13/32	3/8-19	22	0.81	20.6	1.97	50.0	3.02	76.7
UC-BPFX45-0808	36115-0808	20242803	1/2	1/2-14	27	0.83	21.1	2.17	55.1	3.42	86.8
UC-BPFX45-1212 ^C	36115-1212	20242445	3/4	3/4-14	32	1.10	27.9	2.76	70.1	4.31	109.6
UC-BPFX45-1616 ^C	36115-1616	20242801	1	1-11	38	1.34	34.0	3.31	84.1	5.09	129.2

C=Crimp Nut (See Fitting Identification in Appendix for more information.)

BSPB (British Standard Pipe Parallel)

Female / 90° Elbow / Swivel



Part Number	Product Number	SAP Number									
			Hose ID	Thread Size (A)	Hex 1 Wrench Size	Drop (D)	Drop (D)	Cut-Off (C)	Cut-Off (C)	Length (L)	Length (L)
			in.		mm	in.	mm	in.	mm	in.	mm
UC-BPFX90-0404	36120-0404	20242536	1/4	1/4-19	19	1.14	29.0	1.14	29.0	2.12	53.8
UC-BPFX90-0606	36120-0606	20242610	3/8	3/8-19	22	1.65	41.9	1.38	35.1	2.43	61.7
UC-BPFX90-0608	36120-0608	20242805	3/8	1/2-14	27	1.40	35.6	1.34	34.0	2.39	60.7
UC-BPFX90-0706	36120-0706	20979902	13/32	3/8-19	22	1.65	41.9	1.38	35.1	2.43	61.7
UC-BPFX90-0708	36120-0708	20979903	13/32	1/2-14	27	1.40	35.6	1.34	34.0	2.39	60.7
UC-BPFX90-0808	36120-0808	20242556	1/2	1/2-14	27	1.61	40.9	1.42	36.1	2.67	67.7
UC-BPFX90-1212 ^C	36120-1212	20242546	3/4	3/4-14	32	2.09	53.1	1.93	49.0	3.48	88.5
UC-BPFX90-1616 ^C	36120-1616	20242515	1	1-11	38	2.72	69.1	2.95	74.9	4.73	120.0
UC-BPFX90-2020 ^T	36120-2020	20242374	1 1/4	1 1/4-11	50	3.27	83.1	3.23	82.0	5.28	134.1

C=Crimp Nut T=Thrust-Wire Nut (See Fitting Identification in Appendix for more information.)



Download the **MyCrimp App** for more information.

Section 5
UC Fittings



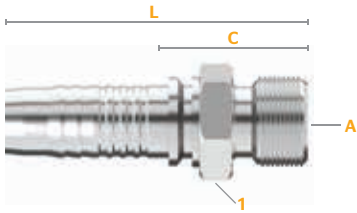

FITTINGS





BSPP (British Standard Pipe Parallel)



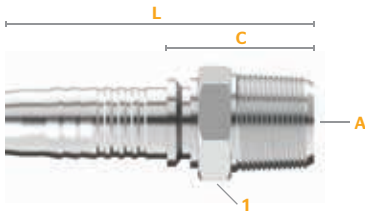

Male

Part Number	Product Number	SAP Number							
			Hose ID	Thread Size (A)	Hex 1 Wrench Size	Cut-Off (C)		Length (L)	
			in.		mm	in.	mm	in.	mm
UC-BPM-0404	36130-0404	20242484	1/4	1/4-19	19	1.03	26.2	2.01	51.1
UC-BPM-0606	36130-0606	20242581	3/8	3/8-19	22	1.10	28.0	2.15	54.6
UC-BPM-0608	36130-0608	20242464	3/8	1/2-14	27	1.24	31.5	2.29	58.1
UC-BPM-0706	36130-0706	20979904	13/32	3/8-19	22	1.10	28.0	2.15	54.6
UC-BPM-0708	36130-0708	20979905	13/32	1/2-14	27	1.24	31.5	2.29	58.1
UC-BPM-0806	36130-0806	20242809	1/2	3/8-19	22	1.12	28.5	2.37	60.2
UC-BPM-0808	36130-0808	20242463	1/2	1/2-14	27	1.26	32.0	2.51	63.7
UC-BPM-1212	36130-1212	20242407	3/4	3/4-14	32	1.45	36.7	3.00	76.1
UC-BPM-1616	36130-1616	20242807	1	1-11	41	1.69	43.0	3.47	88.1
UC-BPM-2020	36130-2020	20242808	1 1/4	1 1/4-11	50	1.89	48.0	3.94	100.0



BSPT (British Standard Pipe Tapered)





Male

Part Number	Product Number	SAP Number							
			Hose ID	Thread Size (A)	Hex 1 Wrench Size	Cut-Off (C)		Length (L)	
			in.		mm	in.	mm	in.	mm
UC-BTM-0404	36170-0404	20242611	1/4	1/4-19	17	1.06	27.0	2.04	51.9
UC-BTM-0406	36170-0406	20923070	1/4	3/8-19		1.09	27.7	2.07	52.6
UC-BTM-0606	36170-0606	20242612	3/8	3/8-19	19	1.10	27.9	2.15	54.6
UC-BTM-0608	36170-0608	20923071	3/8	1/2-14	22	1.28	32.6	2.33	59.3
UC-BTM-0808	36170-0808	20242507	1/2	1/2-14	22	1.31	33.1	2.55	64.8
UC-BTM-1212	36170-1212	20242409	3/4	3/4-14	27	1.36	34.6	2.92	74.1
UC-BTM-1616	36170-1616	20242408	1	1-11	36	1.73	43.9	3.51	89.0

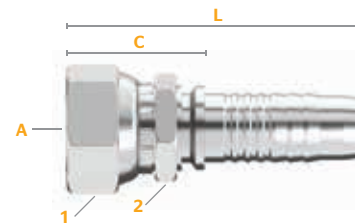
BSP Flat Seat (British Standard Pipe)

Female / Swivel





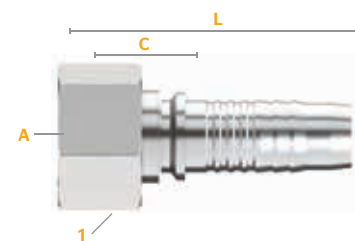

Part Number	Product Number	SAP Number							
			Hose ID	Thread Size (A)	Hex 1 Wrench Size	Cut-Off (C)		Length (L)	
			in.		in.	in.	mm	in.	mm
UC-BFFX-0606	36100-0606	20242800	3/8	3/8-19	22	0.75	19.0	1.80	45.6
UC-BFFX-0608	36100-0608	20242799	3/8	1/2-14	27	0.80	20.2	1.84	46.8
UC-BFFX-0808	36100-0808	20242798	1/2	1/2-14	27	0.82	20.9	2.07	52.5
UC-BFFX-0812	36100-0812	20242285	1/2	3/4-14	32	0.97	24.5	2.21	56.2

DIN 24° Light

Female / Swivel



Part Number	Product Number	SAP Number							
			Hose ID	Thread Size (A)	Hex 1 Wrench Size	Cut-Off (C)		Length (L)	
			in.		mm	in.	mm	in.	mm
UC-DLFX-0412 ^T	36240-0412	20242540	1/4	12x1.5	14	1.07	27.2	2.05	52.0
UC-DLFX-0414	36240-0414	20242594	1/4	14x1.5	17	1.02	25.9	2.00	50.8
UC-DLFX-0416	36240-0416	20242471	1/4	16x1.5	19	1.08	27.4	2.06	52.2
UC-DLFX-0616	36240-0616	20242658	3/8	16x1.5	19	1.21	30.7	2.26	57.5
UC-DLFX-0618	36240-0618	20242641	3/8	18x1.5	22	1.08	27.5	2.13	54.2
UC-DLFX-0716	36240-0716	20979907	13/32	16x1.5	19	1.21	30.7	2.26	57.5
UC-DLFX-0718	36240-0718	20979908	13/32	18x1.5		1.08	27.5	2.13	54.2
UC-DLFX-0822	36240-0822	20242586	1/2	22x1.5	27	1.21	30.7	2.46	62.4
UC-DLFX-1230	36240-1230	20242501	3/4	30x2.0	36	1.42	36.0	2.97	75.4
UC-DLFX-1636	36240-1636	20242453	1	36x2.0	41	1.49	37.9	3.27	83.0
UC-DLFX-2045	36240-2045	20242539	1 1/4	45x2.0	50	1.74	44.1	3.78	96.1
UC-DLFX-3252	36240-3252	20588739	2	52x2.0	60	1.46	37.0	4.29	109.0

T=Thrust-Wire Nut (See Fitting Identification in Appendix for more information.)



Download the **MyCrimp App** for more information.

Section 5
UC Fittings

FITTINGS



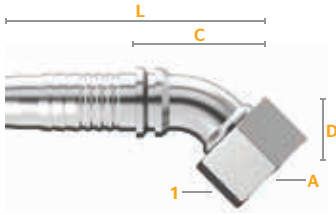

DIN 24° Light

Female / 45° Elbow / Swivel

Part Number	Product Number	SAP Number	Hose ID		Hex 1 Wrench Size		Drop (D)		Cut-Off (C)		Length (L)	
			in.	mm	in.	mm	in.	mm	in.	mm		
UC-DLFX45-0414 ^T	36245-0414	20242385	1/4	14x1.5	17	0.69	17.5	1.69	42.9	2.67	67.8	
UC-DLFX45-0416	36245-0416	20242386	1/4	16x1.5	19	0.79	20.1	1.65	41.9	2.63	66.8	
UC-DLFX45-0618	36245-0618	20242387	3/8	18x1.5	22	0.77	19.6	1.85	47.0	2.90	73.6	
UC-DLFX45-0822	36245-0822	20242329	1/2	22x1.5	27	0.83	21.1	2.17	55.1	3.15	79.9	
UC-DLFX45-1230	36245-1230	20242330	3/4	30x2.0	36	1.26	32.0	2.72	69.1	4.27	108.5	
UC-DLFX45-1636	36245-1636	20242328	1	36x2.0	41	1.26	32.0	3.58	90.9	5.36	136.0	
UC-DLFX45-2045	36245-2045	20884595	1 1/4	45x2.0	50	3.50	88.9	3.54	88.9	5.59	88.9	

T=Thrust-Wire Nut (See Fitting Identification in Appendix for more information.)

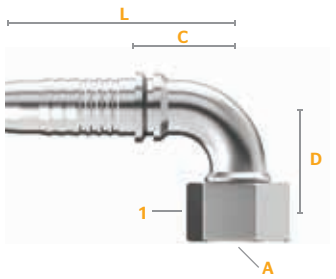

DIN 24° Light

Female / 90° Elbow / Swivel

Part Number	Product Number	SAP Number	Hose ID		Hex 1 Wrench Size		Drop (D)		Cut-Off (C)		Length (L)	
			in.	mm	in.	mm	in.	mm	in.	mm		
UC-DLFX90-0412	36250-0412	20242390	1/4	12x1.5	14	1.02	25.9	1.14	29.0	2.12	53.8	
UC-DLFX90-0414	36250-0414	20242425	1/4	14x1.5	17	1.28	32.5	1.10	27.9	2.08	52.8	
UC-DLFX90-0416	36250-0416	20242391	1/4	16x1.5	19	1.28	32.5	1.10	27.9	2.08	52.8	
UC-DLFX90-0618	36250-0618	20242488	3/8	18x1.5	22	1.54	39.1	1.30	33.0	2.35	59.7	
UC-DLFX90-0822	36250-0822	20242389	1/2	22x1.5	27	1.59	40.4	1.57	39.9	2.82	71.6	
UC-DLFX90-1230	36250-1230	20242332	3/4	30x2.0	36	2.32	58.9	2.05	52.1	3.60	91.5	
UC-DLFX90-1636	36250-1636	20242331	1	36x2.0	41	2.68	68.1	3.07	78.0	4.85	123.1	
UC-DLFX90-2045	36250-2045	20242388	1 1/4	45x2.0	50	3.50	88.9	3.54	89.9	5.59	141.9	

FITTINGS



Section 5

UC Fittings

COMPATIBLE HOSE:





SR1SN	SR5	HR6	SFS	ACP3
SR2SN	DR5	HR4	SCP3	BOP
SR3	SR6	SR14A		

For a detailed list, please refer to your Crimp Specifications Manual.

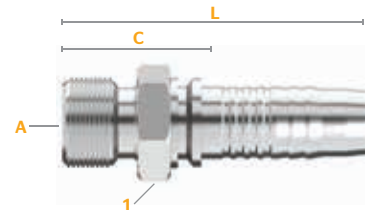
DIN 24° Light

Male





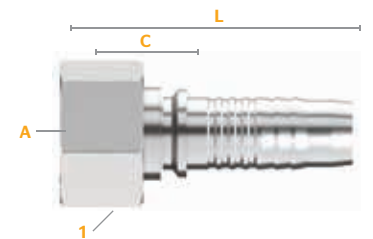

Part Number	Product Number	SAP Number							
			Hose ID	Thread Size (A)	Hex 1 Wrench Size	Cut-Off (C)		Length (L)	
			in.		mm	in.	mm	in.	mm
UC-DLM-0412	36255-0412	20242334	1/4	12x1.5	14	0.84	21.4	1.82	46.3
UC-DLM-0414	36255-0414	20242393	1/4	14x1.5	14	0.84	21.4	1.82	46.3
UC-DLM-0416	36255-0416	20242335	1/4	16x1.5	17	0.92	23.4	1.90	48.3
UC-DLM-0616	36255-0616	20242426	3/8	16x1.5	17	0.93	23.6	1.98	50.2
UC-DLM-0618	36255-0618	20242513	3/8	18x1.5	19	0.96	24.4	2.01	51.1
UC-DLM-0716	36255-0716	20979909	13/32	16x1.5	17	0.93	23.6	1.98	50.2
UC-DLM-0822	36255-0822	20242392	1/2	22x1.5	22	1.02	26.0	2.27	57.6
UC-DLM-1230	36255-1230	20242336	3/4	30x2.0	32	1.24	31.5	2.79	70.9
UC-DLM-1636	36255-1636	20242333	1	36x2.0	36	1.34	34.1	3.12	79.1

DIN 24° Heavy

Female / Swivel



Part Number	Product Number	SAP Number							
			Hose ID	Thread Size (A)	Hex 1 Wrench Size	Cut-Off (C)		Length (L)	
			in.		mm	in.	mm	in.	mm
UC-DHFX-0416	36210-0416	20242538	1/4	16x1.5	19	1.20	30.5	2.18	55.4
UC-DHFX-0418	36210-0418	20242529	1/4	18x1.5	22	1.21	30.8	2.19	55.7
UC-DHFX-0620	36210-0620	20242624	3/8	20x1.5	24	1.21	30.8	2.26	57.4
UC-DHFX-0622	36210-0622	20242562	3/8	22x1.5	27	1.42	36.2	2.47	62.8
UC-DHFX-0722	36210-0722	20979906	13/32	22x1.5	27	1.42	36.2	2.47	62.8
UC-DHFX-0824	36210-0824	20242561	1/2	24x1.5	30	1.44	36.5	2.68	68.2
UC-DHFX-1230 ^T	36210-1230	20242319	3/4	30x2.0	36	1.62	41.0	3.17	80.5
UC-DHFX-1236	36210-1236	20242530	3/4	36x2.0	46	1.89	47.9	3.44	87.4
UC-DHFX-1236S	36210-1236S	20608762	3/4	36x2.0	46	1.89	47.9	3.44	87.4
UC-DHFX-1642	36210-1642	20242500	1	42x2.0	50	1.88	47.9	3.66	92.9

S=Stainless Steel T=Thrust-Wire Nut (See Fitting Identification in Appendix for more information.)



Download the **MyCrimp App** for more information.

Section 5
UC Fittings





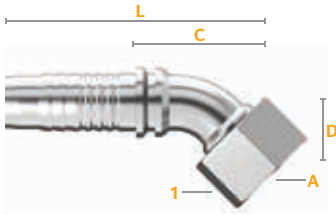

FITTINGS





DIN 24° Heavy





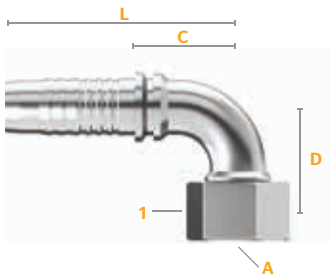

Female / 45° Elbow / Swivel

Part Number	Product Number	SAP Number									
			Hose ID	Thread Size (A)	Hex 1 Wrench Size	Drop (D)		Cut-Off (C)		Length (L)	
			in.		mm	in.	mm	in.	mm	in.	mm
UC-DHFX45-0418	36215-0418	20242313	1/4	18x1.5	22	0.75	19.1	1.69	42.9	2.67	67.8
UC-DHFX45-0620	36215-0620	20242315	3/8	20x1.5	24	0.79	20.1	2.01	51.1	3.06	77.7
UC-DHFX45-0622	36215-0622	20242316	3/8	22x1.5	27	0.83	21.1	2.09	53.1	3.14	79.7
UC-DHFX45-0824	36215-0824	20242312	1/2	24x1.5	30	0.85	21.6	2.20	55.9	3.45	87.6
UC-DHFX45-1236	36215-1236	20242314	3/4	36x2.0	46	1.30	33.0	2.72	69.1	4.27	108.5
UC-DHFX45-1642	36215-1642	20242310	1	42x2.0	50	1.59	40.4	4.33	110.0	6.11	155.1



DIN 24° Heavy

Female / 90° Elbow / Swivel

Part Number	Product Number	SAP Number									
			Hose ID	Thread Size (A)	Hex 1 Wrench Size	Drop (D)		Cut-Off (C)		Length (L)	
			in.		mm	in.	mm	in.	mm	in.	mm
UC-DHFX90-0418	36220-0418	20242421	1/4	18x1.5	22	1.34	34.0	1.06	26.9	2.04	51.8
UC-DHFX90-0620	36220-0620	20242563	3/8	20x1.5	24	1.52	38.6	1.34	34.0	2.39	60.7
UC-DHFX90-0622	36220-0622	20242469	3/8	22x1.5	27	1.59	40.4	1.34	34.0	2.39	60.7
UC-DHFX90-0824	36220-0824	20242468	1/2	24x1.5	30	1.63	41.4	1.57	39.9	2.82	71.6
UC-DHFX90-1236	36220-1236	20242317	3/4	36x2.0	46	2.34	59.4	2.01	51.1	3.56	90.5
UC-DHFX90-1236S	36220-1236S	20608763	3/4	36x2.0	46	2.34	59.4	2.01	51.1	3.56	90.5
UC-DHFX90-1642	36220-1642	20242420	1	42x2.0	50	3.11	79.0	2.99	75.9	4.77	121.0

S=Stainless Steel (See Fitting Identification in Appendix for more information.)

FITTINGS



Section 5

UC Fittings

COMPATIBLE HOSE:





SR1SN	SR5	HR6	SFS	ACP3
SR2SN	DR5	HR4	SCP3	BOP
SR3	SR6	SR14A		

For a detailed list, please refer to your Crimp Specifications Manual.

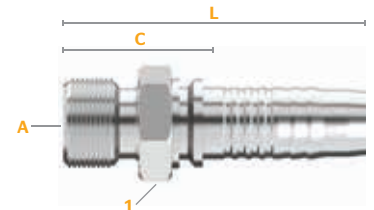
DIN 24° Heavy

Male







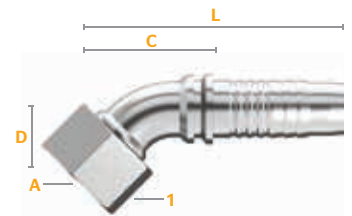

Part Number	Product Number	SAP Number							
			Hose ID	Thread Size (A)	Hex 1 Wrench Size	Cut-Off (C)		Length (L)	
			in.		mm	in.	mm	in.	mm
UC-DHM-0416	36225-0416	20242323	1/4	16x1.5	17	0.95	24.2	1.93	49.1
UC-DHM-0418	36225-0418	20242324	1/4	18x1.5	19	0.99	25.2	1.97	50.1
UC-DHM-0620	36225-0620	20242424	3/8	20x1.5	22	1.00	25.4	2.05	52.1
UC-DHM-0622	36225-0622	20242470	3/8	22x1.5	22	1.08	27.4	2.13	54.1
UC-DHM-0824	36225-0824	20242322	1/2	24x1.5	24	1.14	29.0	2.39	60.7
UC-DHM-1230	36225-1230	20242325	3/4	30x2.0	32	1.33	33.7	2.88	73.1
UC-DHM-1236	36225-1236	20242326	3/4	36x2.0	36	1.48	37.7	3.04	77.1
UC-DHM-1642	36225-1642	20242321	1	42x2.0	46	1.66	42.1	3.43	87.2

DIN 60°

Female / 45° Elbow / Swivel



Part Number	Product Number	SAP Number									
			Hose ID	Thread Size (A)	Hex 1 Wrench Size	Drop (D)	Cut-Off (C)		Length (L)		
			in.		mm	in.	mm	in.	mm	in.	mm
UC-DNFX45-0414	36275-0414	20242338	1/4	14x1.5	17	0.63	16.0	1.38	35.1	2.36	59.9
UC-DNFX45-0416	36275-0416	20242339	1/4	16x1.5	19	0.67	17.0	1.42	36.1	2.40	61.0
UC-DNFX45-0618	36275-0618	20242340	3/8	18x1.5	22	0.77	19.6	1.69	42.9	2.74	69.6
UC-DNFX45-0822	36275-0822	20242337	1/2	22x1.5	27	0.79	20.1	2.17	55.1	3.42	86.8



Download the **MyCrimp App**
for more information.

Section 5
UC Fittings

FITTINGS



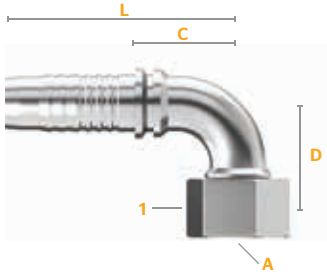

DIN 60°

Female / 90° Elbow / Swivel



Part Number	Product Number	SAP Number	Hose ID	Thread Size (A)	Hex 1 Wrench Size	Drop (D)		Cut-Off (C)		Length (L)	
			in.		mm	in.	mm	in.	mm	in.	mm
UC-DNFX90-0414	36280-0414	20242428	1/4	14x1.5	17	1.28	32.5	1.18	30.0	2.16	54.9
UC-DNFX90-0416	36280-0416	20242341	1/4	16x1.5	19	1.28	32.5	1.10	27.9	2.08	52.8
UC-DNFX90-0616	36280-0616	20242342	3/8	16x1.5	19	1.26	32.0	1.18	30.0	2.23	56.6
UC-DNFX90-0618	36280-0618	20242472	3/8	18x1.5	22	1.46	37.1	1.30	33.0	2.35	59.7
UC-DNFX90-0822	36280-0822	20242427	1/2	22x1.5	27	1.57	39.9	1.57	39.9	2.82	71.6

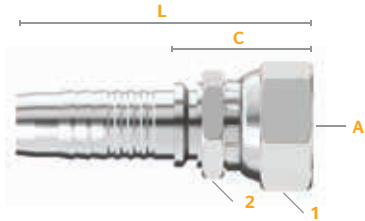

Komatsu® 30° Flare with Metric Threads

Female / Swivel

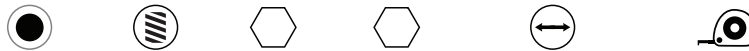

Part Number	Product Number	SAP Number	Hose ID	Thread Size (A)	Hex 1 Wrench Size	Hex 2 Wrench Size	Cut-Off (C)		Length (L)	
			in.		mm	mm	in.	mm	in.	mm
UC-KMFX-0414	36545-0414	20242590	1/4	14x1.5	19	17	1.22	30.9	2.20	55.8
UC-KMFX-0618	36545-0618	20242636	3/8	18x1.5	22	19	1.26	32.1	2.31	58.7
UC-KMFX-0822	36545-0822	20242573	1/2	22x1.5	27	22	1.38	35.2	2.63	66.8
UC-KMFX-1024	36545-1024	20283390	5/8	24x1.5	32	30	1.66	42.2	3.02	76.6
UC-KMFX-1230	36545-1230	20242541	3/4	30x1.5	36	30	1.84	46.7	3.39	86.1
UC-KMFX-1633	36545-1633	20242564	1	33x1.5	41	36	2.24	56.9	4.02	102.0
UC-KMFX-2036	36545-2036	20242394	1 1/4	36x1.5	46	46	2.50	63.6	4.55	115.5

FITTINGS



Section 5

UC Fittings

COMPATIBLE HOSE:





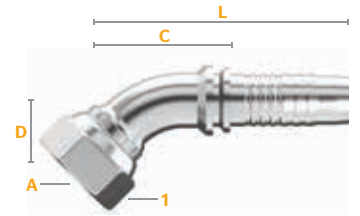

SR1SN	SR5	HR6	SFS	ACP3
SR2SN	DR5	HR4	SCP3	BOP
SR3	SR6	SR14A		

For a detailed list, please refer to your Crimp Specifications Manual.

Komatsu® 30° Flare with Metric Threads

Female / 45° Elbow / Swivel







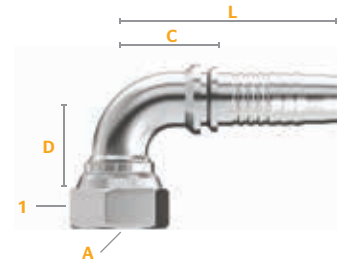

Part Number	Product Number	SAP Number									
			Hose ID	Thread Size (A)	Hex 1 Wrench Size	Drop (D)	Cut-Off (C)	Length (L)	in.	mm	
UC-KMFX45-0414	36548-0414	20318233	in.		mm	in.	mm	in.	mm	in.	mm
UC-KMFX45-0618	36548-0618	20318234	1/4	14x1.5	19	0.61	15.5	1.50	38.1	2.48	63.0
UC-KMFX45-0618	36548-0618	20318234	3/8	18x1.5	22	0.71	18.0	1.73	43.9	2.78	70.6
UC-KMFX45-0822	36548-0822	20318235	1/2	22x1.5	27	1.16	29.5	2.20	55.9	3.45	87.6

Komatsu® 30° Flare with Metric Threads

Female / 90° Elbow / Swivel



Part Number	Product Number	SAP Number									
			Hose ID	Thread Size (A)	Hex 1 Wrench Size	Drop (D)	Cut-Off (C)	Length (L)	in.	mm	
UC-KMFX90-0414	36550-0414	20318236	in.		mm	in.	mm	in.	mm	in.	mm
UC-KMFX90-0414	36550-0414	20318236	1/4	14x1.5	19	1.16	29.5	1.30	33.0	2.28	57.9
UC-KMFX90-0618	36550-0618	20318326	3/8	18x1.5	22	1.40	35.6	1.42	36.0	2.47	62.7
UC-KMFX90-0822	36550-0822	20318327	1/2	22x1.5	27	2.09	53.1	1.74	37.0	2.98	75.8



Download the **MyCrimp App** for more information.

Section 5
UC Fittings





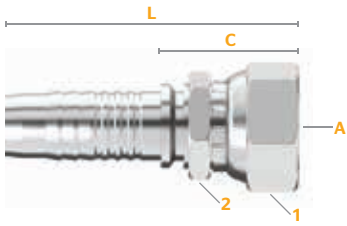

FITTINGS





JIS 30° (Parallel Pipe Threads)



Female / Swivel

Part Number	Product Number	SAP Number								
			Hose ID	Thread Size (A)	Hex 1 Wrench Size	Hex 2 Wrench Size	Cut-Off (C)		Length (L)	
			in.		mm	mm	in.	mm	in.	mm
UC-JSFX-0404	36520-0404	20242644	1/4	1/4-19	19	17	1.22	30.9	2.20	55.8
UC-JSFX-0606	36520-0606	20242699	3/8	3/8-19	22	19	1.26	32.1	2.31	58.7
UC-JSFX-0808	36520-0808	20242606	1/2	1/2-14	27	22	1.39	35.2	2.63	66.9
UC-JSFX-1212	36520-1212	20242543	3/4	3/4-14	36	30	1.58	40.2	3.14	79.6
UC-JSFX-1616	36520-1616	20242502	1	1-11	41	36	1.87	47.5	3.65	92.6
UC-JSFX-2020 ^T	36520-2020	20242436	1 1/4	1 1/4-11	50	46	2.16	54.9	4.21	106.9

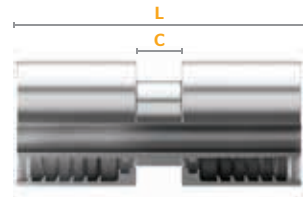
T=Thrust-Wire Nut (See Fitting Identification in Appendix for more information.)



Hose Joiner

Part Number	Product Number	SAP Number					
			Hose ID	in.	mm	in.	mm
UC-HJ-0404	36840-0404	20960631	1/4	0.63	15.9	2.59	65.7
UC-HJ-0505	36840-0505	20960632	5/16	0.63	15.90	2.59	65.7
UC-HJ-0606	36840-0606	20960633	3/8	0.63	15.90	2.72	69.2
UC-HJ-0808	36840-0808	20960634	1/2	0.75	19.10	3.24	82.4
UC-HJ-1010	36840-1010	20960635	5/8	0.75	19.10	3.46	88.0
UC-HJ-1212	36840-1212	20960636	3/4	0.75	19.10	3.86	98.0
UC-HJ-1616	36840-1616	20960637	1	1.00	25.40	4.55	115.6
UC-HJ-2020	36840-2020	20960638	1 1/4	1.50	38.10	5.59	142.0
UC-HJ-2424	36840-2424	20960630	1 1/2	1.50	38.10	6.16	156.4
UC-HJ-3232	36840-3232	20960640	2	1.50	38.10	7.17	182.1

FITTINGS



Section 5

UC Fittings

COMPATIBLE HOSE:

SR1SN	SR5	HR6	SFS	ACP3
SR2SN	DR5	HR4	SCP3	BOP
SR3	SR6	SR14A		

For a detailed list, please refer to your Crimp Specifications Manual.

SECTION 6 - FG FITTINGS

This section lists all fittings compatible with the following hose:

Hose	Description	Compatible Dash Size
SR5	SAE 100R5	All hose dash sizes
DR5	SAE 100R5 / SAE J1942	All hose dash sizes

How to Use the Fittings Table





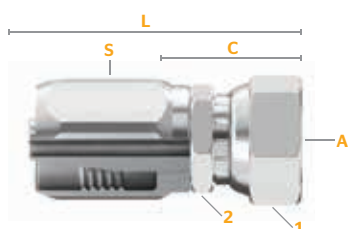

The fittings in this section will follow a similar table structure to the one seen on this page.

Fitting dimensions and attributes are explained below.



Fitting Name

Fitting Description

Part Number	Product Number	SAP Number									
			Hose ID	Thread Size (A)	Hex 1 Wrench Size	Hex 2 Wrench Size	(S) Socket Wrench Size	Cut-Off (C)	Length (L)		
			in.		in.	in.	in.	in.	mm	in.	mm
FG-JCFX-0404	18400-0404	20245798	3/16	7/16-20	9/16	9/16	5/8	1.19	30.2	1.94	49.2
FG-JCFX-0505	18400-0505	20245799	1/4	1/2-20	5/8	5/8	11/16	1.30	32.9	2.08	52.8
FG-JCFX-0606	18400-0606	20245800	5/16	9/16-18	11/16	11/16	13/16	1.41	35.7	2.31	58.7

Fitting Dimensions and Attributes

- Part Number** See Hydraulic Fittings Nomenclature on page 128 for a breakdown of part number attributes
- Hose ID** The compatible Hose ID
- Tube ID** The compatible Tube ID
- Thread Size** The thread size or sizes available for a particular fitting dash size (indicated by **A** in the fitting image)
- Hex Size** The wrench size for one or both nuts on the fitting (indicated by **1** or **2** in the fitting image)
- Drop** The length of the elbow (indicated by **D** in the fitting image)
- Cut-Off** The amount of hose to be cut for a correct assembly length (indicated by **C** in the fitting image)
- Length** The overall length of the fitting

Choose fittings carefully, considering the working pressure of both the hose and fitting. The maximum working pressure of the hose assembly is the lesser of the rated working pressure of the hose and the fitting. See page 389 for the Fittings Working Pressure Guide.



Download the **MyCrimp App** for more information.

Section 6
FG Fittings

FITTINGS



FG Fittings Overview





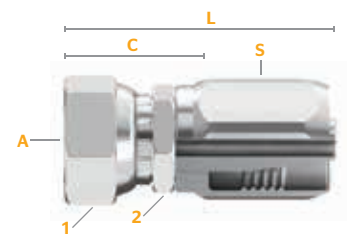

A complete overview of all FG fittings found in this section.

<p>JIC 37° Flare (SAE J514) Female Swivel  FG-JCFX P. 281</p>	<p>JIC 37° Flare (SAE J514) Female 45° Elbow Swivel  FG-JCFX45 P. 281</p>	<p>JIC 37° Flare (SAE J514) Female 90° Elbow Swivel  FG-JCFX90 P. 282</p>	<p>JIC 37° Flare (SAE J514) Male  FG-JCM P. 282</p>
<p>SAE 45° J512 Flare Female Swivel  FG-SFFX P. 283</p>	<p>SAE 45° J512 Flare Male  FG-SFM P. 283</p>	<p>SAE 45° Inverted Flare Male Swivel  FG-SIMX P. 284</p>	<p>NPTF Male  FG-NPM P. 284</p>
<p>O-Ring Boss Straight Thread (SAE J514) Male  FG-OBM P. 285</p>			

JIC 37° Flare (SAE J514)

Female / Swivel









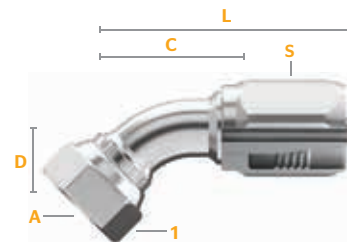

Part Number	Product Number	SAP Number									
			Hose ID	Thread Size (A)	Hex 1 Wrench Size	Hex 2 Wrench Size	(S) Socket Wrench Size	Cut-Off (C)	Length (L)	in.	mm
FG-JCFX-0404	18400-0404	20245798	3/16	7/16-20	9/16	9/16	5/8	1.19	30.2	1.94	49.2
FG-JCFX-0505	18400-0505	20245799	1/4	1/2-20	5/8	5/8	11/16	1.30	32.9	2.08	52.8
FG-JCFX-0606	18400-0606	20245800	5/16	9/16-18	11/16	11/16	13/16	1.41	35.7	2.31	58.7
FG-JCFX-0808	18400-0808	20245801	13/32	3/4-16	7/8	7/8	15/16	1.58	40.1	2.68	68.1
FG-JCFX-1010	18400-1010	20245792	1/2	7/8-14	1	1	1 1/8	1.67	42.5	3.06	77.8
FG-JCFX-1212	18400-1212	20245793	5/8	1 1/8-12	1 1/4	1 1/4	1 1/4	1.92	48.8	3.50	88.9
FG-JCFX-1616	18400-1616	20245794	7/8	1 1/8-12	1 1/2	1 1/2	1 1/8	1.92	48.8	3.19	81.0
FG-JCFX-2020	18400-2020	20245795	1 1/8	1 3/8-12	2	2	1 3/4	2.50	63.5	3.38	85.7
FG-JCFX-2424	18400-2424	20245796	1 3/8	1 7/8-12	2 1/4	2 1/4	2	2.23	56.8	3.66	92.9
FG-JCFX-3232	18400-3232	20245797	1 7/8	2 1/2-12	2 3/8	2 3/8	2 1/2	2.58	65.5	4.44	112.7

JIC 37° Flare (SAE J514)

Female / 45° Elbow / Swivel



Part Number	Product Number	SAP Number											
			Hose ID	Thread Size (A)	Hex 1 Wrench Size	Hex 2 Wrench Size	(S) Socket Wrench Size	Drop (D)	Cut-Off (C)	Length (L)	in.	mm	
FG-JCFX45-0404	18420-0404	20245820	3/16	7/16-20	9/16	9/16	5/8	0.33	8.3	1.11	28.2	1.84	46.8
FG-JCFX45-0505	18420-0505	20245821	1/4	1/2-20	9/16	5/8	11/16	0.36	9.1	1.28	32.5	1.06	27.0
FG-JCFX45-0606	18420-0606	20245822	5/16	9/16-18	9/16	11/16	13/16	0.39	9.9	1.33	33.7	2.23	56.8
FG-JCFX45-0808	18420-0808	20245823	13/32	3/4-16	11/16	7/8	15/16	0.55	13.9	1.84	46.8	2.98	75.8
FG-JCFX45-1010	18420-1010	20245817	1/2	7/8-14	7/8	1	1 1/8	0.62	15.9	1.95	49.6	3.23	82.2
FG-JCFX45-1212	18420-1212	20245818	5/8	1 1/8-12	1 1/8	1 1/4	1 1/4	0.77	19.5	2.22	56.4	3.78	96.0
FG-JCFX45-1616	18420-1616	20245819	7/8	1 1/8-12	1 3/8	1 1/2	1 1/8	0.89	22.6	2.23	56.8	3.56	90.5



Download the **MyCrimp App** for more information.

Section 6
FG Fittings

FITTINGS



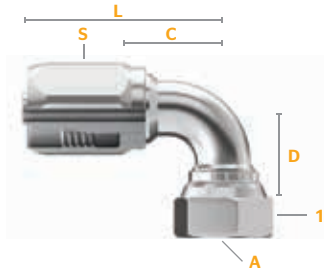

JIC 37° Flare (SAE J514)

Female / 90° Elbow / Swivel



Part Number	Product Number	SAP Number	Hose ID	Thread Size (A)	Hex 1	Hex 2	(S) Socket	Elbow Type*	Drop (D)		Cut-Off (C)		Length (L)	
					Wrench Size	Wrench Size	Wrench Size		in.	mm	in.	mm	in.	mm
FG-JCFX90-0404	18425-0404	20245827	3/16	7/16-20	9/16	9/16	5/8		0.69	17.5	1.00	25.4	1.75	44.5
FG-JCFX90L-0404	18440-0404	20245834	3/16	7/16-20	9/16	9/16	5/8	LT	1.80	45.6	1.00	25.4	1.75	44.5
FG-JCFX90-0505	18425-0505	20245828	1/4	1/2-20	9/16	5/8	11/16		0.77	19.5	1.19	30.2	1.97	50.0
FG-JCFX90L-0505	18440-0505	20245835	1/4	1/2-20	9/16	5/8	11/16	LT	1.78	45.2	1.19	30.2	1.97	50.0
FG-JCFX90-0606	18425-0606	20245829	5/16	9/16-18	11/16	11/16	13/16		0.84	21.4	1.23	31.4	2.12	54.0
FG-JCFX90L-0606	18440-0606	20245836	5/16	9/16-18	11/16	11/16	13/16	LT	2.19	55.6	1.23	31.4	2.12	54.0
FG-JCFX90-0808	18425-0808	20245830	13/32	3/4-16	7/8	7/8	15/16		1.09	27.8	1.61	40.9	2.75	69.9
FG-JCFX90L-0808	18440-0808	20245837	13/32	3/4-16	7/8	7/8	15/16	LT	2.44	61.9	1.61	40.9	2.75	69.9
FG-JCFX90-1010	18425-1010	20245824	1/2	7/8-14	1 1/8	1	1 1/8		1.23	31.4	1.66	42.1	2.94	74.6
FG-JCFX90L-1010	18440-1010	20245831	1/2	7/8-14	1 1/8	1	1 1/8	LT	2.56	65.1	1.66	42.1	2.94	74.6
FG-JCFX90-1212	18425-1212	20245825	5/8	1 1/8-12	1 1/4	1 1/4	1 1/4		1.81	46.0	2.17	55.2	3.75	95.3
FG-JCFX90L-1212	18440-1212	20245832	5/8	1 1/8-12	1 1/4	1 1/4	1 1/4	LT	3.73	94.9	2.17	55.2	3.75	95.3
FG-JCFX90-1616	18425-1616	20245826	7/8	1 1/8-12	1 1/2	1 1/2	1 1/8		2.14	54.4	2.28	57.9	3.55	90.1
FG-JCFX90L-1616	18440-1616	20245833	7/8	1 1/8-12	1 1/2	1 1/2	1 1/8	LT	4.33	109.9	2.28	57.9	3.55	90.1

*Elbow Type: LT=Long Tube

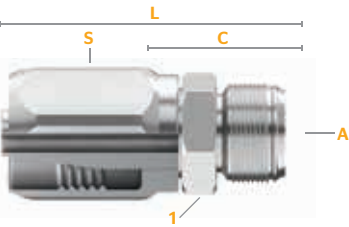

JIC 37° Flare (SAE J514)

Male







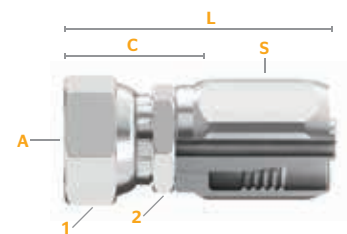

Part Number	Product Number	SAP Number	Hose ID	Thread Size (A)	Hex 1	Socket (S)	Cut-Off (C)	Length (L)		
					Wrench Size	Wrench Size		in.	mm	
FG-JCM-0404	18450-0404	20245775	3/16	7/16-20	1/2	5/8	1.09	27.8	1.84	46.8
FG-JCM-0505	18450-0505	20245776	1/4	1/2-20	9/16	11/16	1.17	29.8	1.95	49.6
FG-JCM-0606	18450-0606	20245777	5/16	9/16-18	5/8	13/16	1.22	31.0	2.12	54.0
FG-JCM-0808	18450-0808	20245778	13/32	3/4-16	13/16	15/16	1.31	33.3	2.56	65.1
FG-JCM-1010	18450-1010	20245770	1/2	7/8-14	15/16	1 1/8	1.50	38.1	2.89	73.4
FG-JCM-1212	18450-1212	20245771	5/8	1 1/8-12	1 1/8	1 1/4	1.78	45.2	3.34	84.9
FG-JCM-1616	18450-1616	20245772	7/8	1 1/8-12	1 3/8	1 1/8	1.69	42.9	2.94	74.6
FG-JCM-2020	18450-2020	20245773	1 1/8	1 1/8-12	1 3/4	1 3/4	1.77	44.9	3.12	79.4
FG-JCM-2424	18450-2424	20245774	1 3/8	1 1/8-12	2	2	1.97	50.0	3.42	86.9

SAE 45° J512 Flare

Female / Swivel







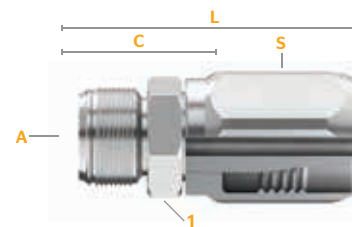

Part Number	Product Number	SAP Number									
			Hose ID	Thread Size (A)	Hex 1 Wrench Size	Hex 2 Wrench Size	(S) Socket Wrench Size	Cut-Off (C)	Length (L)		
			in.		in.	in.	in.	in.	mm	in.	mm
FG-SFFX-0404	18775-0404	20245814	3/16	7/16-20	9/16	9/16	5/8	1.19	30.2	1.94	49.2
FG-SFFX-0505	18775-0505	20245815	1/4	1/2-20	5/8	5/8	11/16	1.30	32.9	2.08	52.8
FG-SFFX-0606	18775-0606	20245816	5/16	5/8-18	3/4	3/4	13/16	1.44	36.5	2.34	59.5
FG-SFFX-0808	18775-0808	20291192	13/32	3/4-16	7/8	7/8	7/8	1.60	40.6	2.70	68.6
FG-SFFX-1010	18775-1010	20245812	1/2	7/8-14	1	1	1 1/2	1.67	42.5	3.06	77.8
FG-SFFX-1212	18775-1212	20245813	5/8	1 1/8-14	1 1/4	1 1/4	1 1/4	1.92	48.8	3.50	88.9

SAE 45° J512 Flare

Male



Part Number	Product Number	SAP Number								
			Hose ID	Thread Size (A)	Hex 1 Wrench Size	(S) Socket Wrench Size	Cut-Off (C)	Length (L)		
			in.		mm	in.	in.	mm	in.	mm
FG-SFM-0404	18785-0404	20245626	3/16	7/16-20	1/2	5/8	1.03	26.2	1.80	45.6
FG-SFM-0505	18785-0505	20245627	1/4	1/2-20	9/16	11/16	1.19	30.2	1.97	50.0
FG-SFM-0606	18785-0606	20245628	5/16	5/8-18	11/16	13/16	1.28	32.5	2.19	55.6
FG-SFM-0808	18785-0808	20245629	13/32	3/4-16	13/16	15/16	1.41	35.7	2.66	67.5
FG-SFM-1212	18785-1212	20245625	5/8	1 1/8-14	1 1/2	1 1/4	1.81	46.0	3.50	88.9



Download the **MyCrimp App** for more information.

Section 6
FG Fittings

FITTINGS



SAE 45° Inverted Flare

Male / Swivel

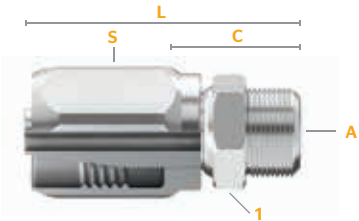

Part Number	Product Number	SAP Number	Hose ID	Thread Size (A)	Hex 1 Wrench Size	(S) Socket Wrench Size	Cut-Off (C)		Length (L)	
			in.		mm	in.	in.	mm	in.	mm
FG-SIMX-0404	18800-0404	20245779	3/16	7/16-24	3/8	5/8	1.72	43.7	2.47	62.7
FG-SIMX-0505	18800-0505	20245780	1/4	1/2-20	7/16	11/16	1.84	46.8	2.62	66.7
FG-SIMX-0606	18800-0606	20245781	5/16	5/8-18	1/2	13/16	1.81	46.0	2.72	69.1
FG-SIMX-0808	18800-0808	20245782	13/32	3/4-18	5/8	15/16	1.98	50.4	3.12	79.4

NPTF

Male

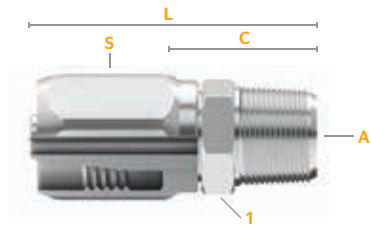





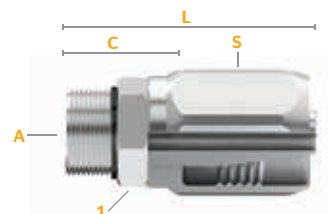

Part Number	Product Number	SAP Number	Hose ID	Thread Size (A)	Hex 1 Wrench Size	(S) Socket Wrench Size	Cut-Off (C)		Length (L)	
			in.		mm	in.	in.	mm	in.	mm
FG-NPM-0402	18615-0402	20245804	3/16	1/8-27	9/16	5/8	0.92	23.4	1.67	42.5
FG-NPM-0404	18615-0404	20245805	3/16	1/4-18	9/16	5/8	1.11	28.2	1.86	47.2
FG-NPM-0504	18615-0504	20245806	1/4	1/4-18	9/16	11/16	1.19	30.2	1.97	50.0
FG-NPM-0604	18615-0604	20245807	5/16	1/4-18	9/16	13/16	1.23	31.4	2.17	55.2
FG-NPM-0606	18615-0606	20245808	5/16	3/8-18	11/16	13/16	1.27	32.2	2.20	56.0
FG-NPM-0806	18615-0806	20245809	13/32	3/8-18	11/16	15/16	1.33	33.7	2.48	63.1
FG-NPM-0808	18615-0808	20245811	13/32	1/2-14	7/8	15/16	1.56	39.7	2.72	69.1
FG-NPM-1008	18615-1008	20245810	1/2	1/2-14	7/8	1 1/8	1.59	40.5	2.86	72.6
FG-NPM-1012	18615-1012	20245802	1/2	3/4-14	1 1/8	1 1/8	1.66	42.1	2.91	73.8
FG-NPM-1212	18615-1212	20245803	5/8	3/4-14	1 1/8	1 1/4	1.67	42.5	3.20	81.4
FG-NPM-1612	18615-1612	20245842	7/8	3/4-14	1 3/8	1 7/8	1.53	38.9	2.80	71.0
FG-NPM-1616	18615-1616	20245841	7/8	1-11 1/2	1 3/8	1 7/8	1.72	43.7	2.98	75.8
FG-NPM-2020	18615-2020	20245838	1 1/8	1 1/4-11 1/2	1 3/4	1 3/4	1.83	46.4	3.19	81.0
FG-NPM-2424	18615-2424	20245840	1 3/8	1 1/2-11 1/2	2	2	1.92	48.8	3.36	85.3
FG-NPM-3232	18615-3232	20245839	1 7/8	2-11 1/2	2 1/2	2 1/2	2.06	52.4	3.91	99.2

O-Ring Boss Straight Thread (SAE J514)

Male



Part Number	Product Number	SAP Number								
			Hose ID	Thread Size (A)	Hex 1 Wrench Size	(S) Socket Wrench Size	Cut-Off (C)	Length (L)	in.	mm
FG-OBM-0404	18670-0404	20245788	3/16	7/16-20	9/16	5/8	0.89	22.6	1.64	41.7
FG-OBM-0505	18670-0505	20245789	1/4	1/2-20	5/8	11/16	0.97	24.6	1.75	44.5
FG-OBM-0606	18670-0606	20245790	5/16	9/16-18	11/16	13/16	1.03	26.2	1.94	49.2
FG-OBM-0808	18670-0808	20245791	13/32	3/4-16	7/8	15/16	1.09	27.8	2.34	59.5
FG-OBM-1010	18670-1010	20245783	1/2	7/8-14	1	1 1/8	1.23	31.4	2.62	66.7
FG-OBM-1212	18670-1212	20245784	5/8	1 1/8-12	1 1/4	1 1/4	1.53	38.9	3.09	78.6
FG-OBM-1616	18670-1616	20245785	7/8	1 5/8-12	1 1/2	1 5/8	1.39	35.3	2.66	67.5
FG-OBM-2020	18670-2020	20245786	1 1/8	1 3/4-12	1 3/4	1 3/4	1.39	35.3	2.75	69.9
FG-OBM-2424	18670-2424	20245787	1 3/8	1 7/8-12	2 1/8	2	1.39	35.3	2.84	72.2



Download the **MyCrimp App** for more information.

Section 6
FG Fittings

FITTINGS



SECTION 7 - TP FITTINGS

This section lists all fittings compatible with the following hose:

Hose	Description	Compatible Dash Size	Hose	Description	Compatible Dash Size
SR7	SAE 100R7 / EN 855 R7	All hose dash sizes	SR8	SAE 100R8 / EN 855 R8	All hose dash sizes
TR7	SAE 100R7 (Twin-Line)	All hose dash sizes	TR8	SAE 100R8 (Twin-Line)	All hose dash sizes
NR7	SAE 100R7	All hose dash sizes	NR8	SAE 100R8	All hose dash sizes
BR7	SAE 100R7	All hose dash sizes	SR18	SAE 100R18	All hose dash sizes

How to Use the Fittings Table





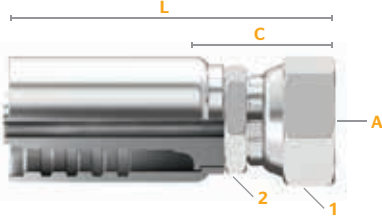

The fittings in this section will follow a similar table structure to the one seen on this page.

Fitting dimensions and attributes are explained below.



Fitting Name

Fitting Description

Fitting Dimensions and Attributes

Part Number See Hydraulic Fittings Nomenclature on page 128 for a breakdown of part number attributes

Hose ID The compatible Hose ID

Tube ID The compatible Tube ID

Thread Size The thread size or sizes available for a particular fitting dash size (indicated by **A** in the fitting image)

Hex Size The wrench size for one or both nuts on the fitting (indicated by **1** or **2** in the fitting image)

Drop The length of the elbow (indicated by **D** in the fitting image)

Cut-Off The amount of hose to be cut for a correct assembly length (indicated by **C** in the fitting image)

Length The overall length of the fitting

Skive Type For applicable fittings, a skive type will be indicated as Skive, Non-Skive or Dual-Grip

Choose fittings carefully, considering the working pressure of both the hose and fitting. The maximum working pressure of the hose assembly is the lesser of the rated working pressure of the hose and the fitting. See page 389 for the Fittings Working Pressure Guide.

FITTINGS



Section 7 TP Fittings



























COMPATIBLE HOSE:

SR7	NR7	SR8	NR8
TR7	BR7	TR8	SR18

For a detailed list, please refer to your Crimp Specifications Manual.

TP Fittings Overview

A complete overview of all TP fittings found in this section.

<p>JIC 37° Flare (SAE J514) Female Swivel</p>  <p>TP-JCFX P. 288</p>	<p>JIC 37° Flare (SAE J514) Female 45° Elbow Swivel</p>  <p>TP-JCFX45 P. 289</p>	<p>JIC 37° Flare (SAE J514) Female 90° Elbow Swivel</p>  <p>TP-JCFX90 P. 290</p>	<p>JIC 37° Flare (SAE J514) Male</p>  <p>TP-JCM P. 291</p>
<p>SAE 45° J512 Flare Female Swivel</p>  <p>TP-SFFX P. 292</p>	<p>SAE 45° J512 Flare Female 90° Elbow Swivel</p>  <p>TP-SFFX90 P. 292</p>	<p>SAE 45° Inverted Flare Male Swivel</p>  <p>TP-SIMX P. 293</p>	<p>SAE 45° Inverted Flare Male 45° Elbow Swivel</p>  <p>TP-SIMX45 P. 293</p>
<p>SAE 45° Inverted Flare Male 90° Elbow Swivel</p>  <p>TP-SIMX90 P. 293</p>	<p>NPTF Female</p>  <p>TP-NPF P. 294</p>	<p>NPTF Male</p>  <p>TP-NPM P. 294</p>	<p>NPTF Male Swivel</p>  <p>TP-NPMX P. 296</p>
<p>NPSM Female Swivel</p>  <p>TP-NSFX P. 296</p>	<p>SAE J514 Flareless Tube Fittings Male</p>  <p>TP-FTM P. 297</p>	<p>Standpipe 45° Elbow</p>  <p>TP-SP45 P. 297</p>	<p>O-Ring Face Seal (SAE J1453 ORS/ORFS) Female Swivel</p>  <p>TP-OFFX P. 298</p>
<p>O-Ring Face Seal (SAE J1453 ORS/ORFS) Female 45° Elbow Swivel</p>  <p>TP-OFFX45 P. 298</p>	<p>O-Ring Face Seal (SAE J1453 ORS/ORFS) Female 90° Elbow Swivel</p>  <p>TP-OFFX90 P. 299</p>	<p>O-Ring Face Seal (SAE J1453 ORS/ORFS) Male</p>  <p>TP-OFM P. 299</p>	<p>O-Ring Boss Straight Thread (SAE J514) Male</p>  <p>TP-OBM P. 300</p>
<p>O-Ring Boss Straight Thread (SAE J514) Male Swivel</p>  <p>TP-OBMX P. 300</p>	<p>O-Ring Boss Straight Thread (SAE J514) Male 90° Block Elbow Swivel</p>  <p>TP-OBMX90B P. 301</p>	<p>BSPP (British Standard Pipe Parallel) Female Swivel</p>  <p>TP-BPFX P. 301</p>	<p>BSPP (British Standard Pipe Parallel) Female 90° Elbow Swivel</p>  <p>TP-BPFX90 P. 302</p>
<p>DIN 60° Female 90° Elbow Swivel</p>  <p>TP-DNFX90 P. 302</p>	<p>JIS 30° (Parallel Pipe Threads) Female Swivel</p>  <p>TP-JSFX P. 302</p>		



Download the **MyCrimp App** for more information.

Section 7
TP Fittings





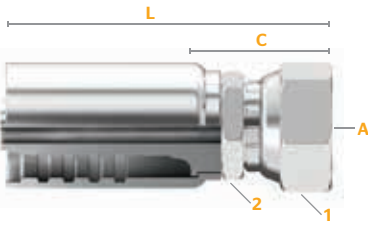

FITTINGS





JIC 37° Flare (SAE J514)

Female / Swivel

Part Number	Product Number	SAP Number								
			Hose ID	Thread Size (A)	Hex 1 Wrench Size	Hex 2 Wrench Size	Cut-Off (C)	Length (L)	in.	mm
T7-JCFX-0204	32400-0204	20243997	1/8	7/16-20	5/8	1/2	1.06	27.0	1.71	43.5
T7-JCFX-0303	32400-0303	20243995	3/16	3/8-24	9/16	9/16	1.31	33.3	2.21	56.2
T7-JCFX-0304	32400-0304	20243994	3/16	7/16-20	5/8	9/16	1.38	34.9	2.16	54.8
T8-JCFX-0304	34400-0304	20243993	3/16	7/16-20	5/8	9/16	1.38	34.9	2.16	54.8
T7-JCFX-0305	32400-0305	20243996	3/16	1/2-20	3/4	9/16	1.38	34.9	2.16	54.8
T8-JCFX-0305	34400-0305	20243999	3/16	1/2-20	3/4	9/16	1.38	34.9	2.16	54.8
T7-JCFX-0404	32400-0404	20244000	1/4	7/16-20	5/8	5/8	1.44	36.5	2.53	64.3
T7-JCFX-0404S	32400-0404S	20298359	1/4	7/16-20	5/8	5/8	1.44	36.5	2.53	64.3
T8-JCFX-0404	34400-0404	20243991	1/4	7/16-20	5/8	5/8	1.44	36.5	2.53	64.3
T8-JCFX-0404S	34400-0404S	20435884	1/4	7/16-20	5/8	5/8	1.44	36.5	2.53	64.3
T7-JCFX-0405	32400-0405	20244002	1/4	1/2-20	3/4	5/8	1.44	36.5	2.53	64.3
T8-JCFX-0405	34400-0405	20244001	1/4	1/2-20	3/4	5/8	1.44	36.5	2.53	64.3
T7-JCFX-0406	32400-0406	20244007	1/4	9/16-18	3/4	5/8	1.44	36.5	2.53	64.3
T8-JCFX-0406	34400-0406	20243998	1/4	9/16-18	3/4	5/8	1.44	36.5	2.53	64.3
T7-JCFX-0505	32400-0505	20244010	5/16	1/2-20	3/4	5/8	1.25	31.8	2.53	64.3
T7-JCFX-0506	32400-0506	20244009	5/16	9/16-18	3/4	5/8	1.38	34.9	2.53	64.3
T7-JCFX-0604	32400-0604	20244015	3/8	7/16-20	5/8	13/16	1.25	31.8	2.69	68.3
T8-JCFX-0604	34400-0604	20244014	3/8	7/16-20	5/8	13/16	1.25	31.8	2.69	68.3
T7-JCFX-0606	32400-0606	20244011	3/8	9/16-18	3/4	3/4	1.50	38.1	2.81	71.5
T8-JCFX-0606	34400-0606	20244008	3/8	9/16-18	3/4	3/4	1.38	34.9	2.81	71.5
T7-JCFX-0608	32400-0608	20244017	3/8	3/4-16	15/16	3/4	1.38	34.9	2.81	71.5
T8-JCFX-0608	34400-0608	20244018	3/8	3/4-16	15/16	3/4	1.38	34.9	2.81	71.5
T7-JCFX-0610	32400-0610	20244013	3/8	7/8-14	1 1/8	7/8	1.50	38.1	2.97	75.4
T8-JCFX-0610	34400-0610	20244012	3/8	7/8-14	1 1/8	7/8	1.50	38.1	2.97	75.4
T7-JCFX-0808	32400-0808	20243932	1/2	3/4-16	15/16	7/8	1.62	41.3	3.16	80.2
T8-JCFX-0808	34400-0808	20244006	1/2	3/4-16	15/16	7/8	1.62	41.3	3.16	80.2
T7-JCFX-0810	32400-0810	20244005	1/2	7/8-14	1 1/8	7/8	1.62	41.3	3.16	80.2
T8-JCFX-0810	34400-0810	20244004	1/2	7/8-14	1 1/8	7/8	1.62	41.3	3.16	80.2
T7-JCFX-0812	32400-0812	20243934	1/2	1 1/8-12	1 1/4	1 1/8	1.62	41.3	3.25	82.6
T8-JCFX-0812	34400-0812	20243935	1/2	1 1/8-12	1 1/4	1 1/8	1.62	41.3	3.25	82.6
T7-JCFX-1210	32400-1210	20244016	3/4	7/8-14	1 1/8	1 1/8	1.62	41.3	3.44	87.3
T7-JCFX-1212	32400-1212	20243992	3/4	1 1/8-12	1 1/4	1 1/8	1.62	41.3	3.44	87.3
T7-JCFX-1216	32400-1216	20244019	3/4	1 3/8-12	1 1/2	1 3/8	1.69	42.9	3.50	88.9
T7-JCFX-1616	32400-1616	20243933	1	1 3/8-12	1 1/2	1 3/8	1.69	42.9	4.06	103.2

S=Stainless Steel (See Fitting Identification in Appendix for more information.)

FITTINGS



Section 7

TP Fittings

COMPATIBLE HOSE:





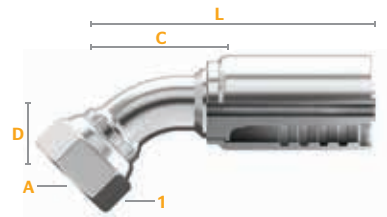

SR7 NR7 SR8 NR8
TR7 BR7 TR8 SR18

For a detailed list, please refer to your Crimp Specifications Manual.

JIC 37° Flare (SAE J514)

Female / 45° Elbow / Swivel



Part Number	Product Number	SAP Number										
			Hose ID	Thread Size (A)	Hex 1 Wrench Size	Hex 2 Wrench Size	Drop (D)	Cut-Off (C)	Length (L)	in.	mm	
			in.		mm	mm	in.	mm	in.	mm	in.	mm
T7-JCFX45-0404	32420-0404	20243938	1/4	7/16-20	9/16	5/8	0.47	11.9	1.50	38.1	2.55	64.9
T8-JCFX45-0404	34420-0404	20243939	1/4	7/16-20	9/16	5/8	0.47	11.9	1.50	38.1	2.55	64.9
T8-JCFX45-0405	34420-0405	20243950	1/4	1/2-20	5/8	5/8	0.53	13.4	1.56	39.7	2.64	67.2
T7-JCFX45-0406	32420-0406	20243940	1/4	9/16-18	11/16	5/8	0.39	9.9	1.94	49.2	3.04	77.3
T8-JCFX45-0406	34420-0406	20243941	1/4	9/16-18	11/16	5/8	0.59	14.9	1.69	42.9	2.73	69.3
T7-JCFX45-0506	32420-0506	20243965	5/16	9/16-18	11/16	5/8	0.39	9.9	1.94	49.2	3.11	79.0
T7-JCFX45-0606	32420-0606	20243936	3/8	9/16-18	11/16	3/4	0.39	9.9	1.94	49.2	3.30	83.8
T8-JCFX45-0606	34420-0606	20243945	3/8	9/16-18	11/16	3/4	0.39	9.9	1.94	49.2	3.30	83.8
T7-JCFX45-0608	32420-0608	20243943	3/8	3/4-16	7/8	3/4	0.55	14.0	2.25	57.2	3.54	89.9
T8-JCFX45-0608	34420-0608	20243944	3/8	3/4-16	7/8	3/4	0.55	14.0	2.25	57.2	3.54	89.9
T7-JCFX45-0808	32420-0808	20243949	1/2	3/4-16	7/8	7/8	0.71	18.1	1.62	41.3	3.28	83.4
T8-JCFX45-0808	34420-0808	20243947	1/2	3/4-16	7/8	7/8	0.71	18.1	1.62	41.3	3.28	83.4
T7-JCFX45-0810	32420-0810	20243951	1/2	7/8-14	1	7/8	0.84	21.3	1.88	47.6	3.91	99.3
T8-JCFX45-0810	34420-0810	20243952	1/2	7/8-14	1	7/8	0.63	16.0	2.25	57.2	3.91	99.3
T7-JCFX45-1212	32420-1212	20243946	3/4	1 1/16-12	1 1/4	1 1/8	0.63	16.0	2.25	57.2	4.33	110.0
T7-JCFX45-1616	32420-1616	20243948	1	1 3/16-12	1 1/2	1 3/8	1.15	29.1	2.62	66.7	5.02	127.5
T7-JCFX45-1616	32420-1616	20243948	1	1 3/16-12	1 1/2	1 3/8	1.15	29.1	2.62	66.7	5.02	127.5



Download the **MyCrimp App** for more information.

Section 7
TP Fittings

FITTINGS



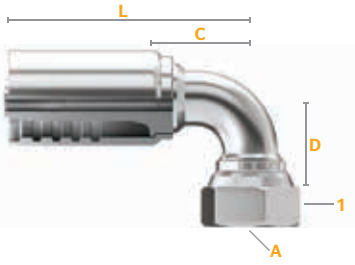

JIC 37° Flare (SAE J514)

Female / 90° Elbow / Swivel



Part Number	Product Number	SAP Number	Hose ID		Thread Size (A)		Hex 1	Hex 2	Elbow Type*	Drop (D)		Cut-Off (C)		Length (L)	
			in.	mm	in.	mm	Wrench Size	Wrench Size		in.	mm	in.	mm	in.	mm
T7-JCFX90-0404	32425-0404	20243919	1/4	7/16-20	9/16	5/8				0.68	17.3	1.69	42.9	2.76	70.0
T8-JCFX90-0404	34425-0404	20243931	1/4	7/16-20	9/16	5/8				0.68	17.3	1.69	42.9	2.76	70.0
T7-JCFX90L-0404	32440-0404	20243958	1/4	7/16-20	9/16	5/8		LT		1.80	45.7	1.25	31.8	2.31	58.7
T8-JCFX90L-0404	34440-0404	20243957	1/4	7/16-20	9/16	5/8		LT		1.80	45.7	1.25	31.8	2.31	58.7
T7-JCFX90-0405	32425-0405	20243929	1/4	1/2-20	5/8	5/8				1.00	25.4	1.31	33.3	2.38	60.3
T8-JCFX90-0405	34425-0405	20243930	1/4	1/2-20	5/8	5/8				1.00	25.4	1.31	33.3	2.38	60.3
T7-JCFX90L-0405	32440-0405	20243968	1/4	1/2-20	5/8	5/8		LT		1.77	45.0	1.30	32.9	2.38	60.3
T8-JCFX90L-0405	34440-0405	20243969	1/4	1/2-20	5/8	5/8		LT		1.77	45.0	1.31	33.3	2.38	60.3
T7-JCFX90-0406	32425-0406	20243927	1/4	9/16-18	11/16	5/8				1.12	28.6	1.94	49.2	3.25	82.6
T8-JCFX90-0406	34425-0406	20243916	1/4	9/16-18	11/16	5/8				1.12	28.6	1.31	33.3	2.41	61.1
T7-JCFX90L-0406	32440-0406	20243954	1/4	9/16-18	11/16	5/8		LT		2.18	55.4	1.19	30.2	2.44	61.9
T8-JCFX90L-0406	34440-0406	20243955	1/4	9/16-18	11/16	5/8		LT		2.18	55.4	1.19	30.2	2.44	61.9
T7-JCFX90-0505	32425-0505	20243922	5/16	1/2-20	5/8	5/8				1.00	25.4	1.12	28.6	2.38	60.3
T7-JCFX90-0506	32425-0506	20243937	5/16	9/16-18	11/16	5/8				0.85	21.6	1.88	47.6	3.06	77.7
T7-JCFX90L-0506	32440-0506	20243960	5/16	9/16-18	11/16	5/8		LT		2.18	55.4	1.19	30.2	2.44	61.9
T7-JCFX90-0606	32425-0606	20243920	3/8	9/16-18	11/16	3/4				0.85	21.6	1.94	49.2	3.25	82.6
T8-JCFX90-0606	34425-0606	20243921	3/8	9/16-18	11/16	3/4				0.85	21.6	1.94	49.2	3.25	82.6
T7-JCFX90L-0606	32440-0606	20243953	3/8	9/16-18	11/16	3/4		LT		2.18	55.4	1.94	49.2	3.24	82.3
T8-JCFX90L-0606	34440-0606	20243959	3/8	9/16-18	11/16	3/4		LT		2.18	55.4	1.94	49.2	3.24	82.3
T7-JCFX90-0608	32425-0608	20243923	3/8	3/4-16	7/8	3/4				1.09	27.7	2.00	50.8	3.34	84.8
T8-JCFX90-0608	34425-0608	20243918	3/8	3/4-16	7/8	3/4				1.09	27.7	2.00	50.8	3.34	84.8
T7-JCFX90L-0608	32440-0608	20243956	3/8	3/4-16	7/8	3/4		LT		2.43	61.7	1.31	33.3	2.75	69.9
T8-JCFX90L-0608	34440-0608	20243962	3/8	3/4-16	7/8	3/4		LT		2.43	61.7	1.31	33.3	2.75	69.9
T7-JCFX90-0808	32425-0808	20243925	1/2	3/4-16	7/8	7/8				1.09	27.7	1.94	49.2	3.53	89.7
T8-JCFX90-0808	34425-0808	20243926	1/2	3/4-16	7/8	7/8				1.09	27.7	1.94	49.2	3.53	89.7
T7-JCFX90L-0808	32440-0808	20243970	1/2	3/4-16	7/8	7/8		LT		2.43	61.7	1.31	33.3	2.94	74.6
T8-JCFX90L-0808	34440-0808	20243964	1/2	3/4-16	7/8	7/8		LT		2.43	61.7	1.31	33.3	2.94	74.6
T7-JCFX90-0810	32425-0810	20243924	1/2	7/8-14	1	7/8				1.23	31.2	2.19	55.6	3.74	95.0
T8-JCFX90-0810	34425-0810	20243928	1/2	7/8-14	1	7/8				1.23	31.2	2.19	55.6	3.74	95.0
T7-JCFX90L-0810	32440-0810	20243966	1/2	7/8-14	1	7/8		LT		2.57	65.3	2.19	55.6	3.77	95.8
T8-JCFX90L-0810	34440-0810	20243967	1/2	7/8-14	1	7/8		LT		2.57	65.3	2.19	55.6	3.77	95.8
T7-JCFX90-1212	32425-1212	20243917	3/4	1 1/8-12	1 1/4	1 1/8				2.31	58.7	2.06	52.4	3.88	98.4
T7-JCFX90-1616	32425-1616	20243961	1	1 3/8-12	1 1/2	1 3/8				2.50	63.5	2.94	74.6	4.75	120.7
T7-JCFX90L-1616	32440-1616	20243963	1	1 3/8-12	1 1/2	1 3/8		LT		4.33	110.0	2.31	58.7	4.69	119.1

*Elbow Type: LT=Long Tube

FITTINGS



Section 7

TP Fittings

COMPATIBLE HOSE:





SR7 NR7 SR8 NR8
TR7 BR7 TR8 SR18

For a detailed list, please refer to your Crimp Specifications Manual.

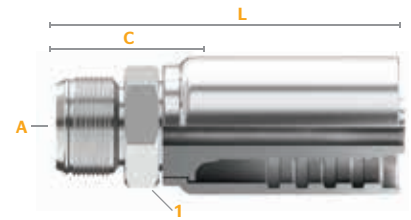
JIC 37° Flare (SAE J514)

Male



Part Number	Product Number	SAP Number							
			Hose ID	Thread Size (A)	Hex 1 Wrench Size	Cut-Off (C)		Length (L)	
			in.		mm	in.	mm	in.	mm
T7-JCM-0304	32450-0304	20243990	3/16	7/16-20	9/16	1.25	31.8	2.05	52.1
T8-JCM-0304	34450-0304	20243989	3/16	7/16-20	9/16	1.25	31.8	2.05	52.1
T7-JCM-0404	32450-0404	20243973	1/4	7/16-20	5/8	1.25	31.8	2.30	58.4
T8-JCM-0404	34450-0404	20243972	1/4	7/16-20	5/8	1.25	31.8	2.30	58.4
T7-JCM-0405	32450-0405	20243975	1/4	1/2-20	5/8	1.25	31.8	2.30	58.4
T8-JCM-0405	34450-0405	20243974	1/4	1/2-20	5/8	1.25	31.8	2.30	58.4
T7-JCM-0406	32450-0406	20243985	1/4	9/16-18	3/4	1.32	33.5	2.40	61.0
T8-JCM-0406	34450-0406	20243978	1/4	9/16-18	3/4	1.31	33.3	2.40	61.0
T7-JCM-0505	32450-0505	20243982	5/16	1/2-20	5/8	1.06	27.0	2.36	60.0
T7-JCM-0506	32450-0506	20243981	5/16	9/16-18	11/16	1.31	33.3	2.30	58.4
T7-JCM-0606	32450-0606	20243984	3/8	9/16-18	3/4	1.38	34.9	2.59	65.7
T8-JCM-0606	34450-0606	20243983	3/8	9/16-18	3/4	1.12	28.6	2.59	65.7
T7-JCM-0608	32450-0608	20243987	3/8	3/4-16	13/16	1.38	34.9	2.69	68.3
T8-JCM-0608	34450-0608	20243986	3/8	3/4-16	13/16	1.25	31.8	2.69	68.3
T7-JCM-0808	32450-0808	20243979	1/2	3/4-16	7/8	1.44	36.5	2.88	73.1
T8-JCM-0808	34450-0808	20243971	1/2	3/4-16	7/8	1.25	31.8	2.88	73.1
T7-JCM-0810	32450-0810	20243977	1/2	7/8-14	15/16	1.44	36.5	3.10	78.8
T8-JCM-0810	34450-0810	20243976	1/2	7/8-14	15/16	1.50	38.1	3.10	78.8
T7-JCM-1212	32450-1212	20243988	3/4	1 1/8-12	1 1/8	1.50	38.1	3.32	84.4
T7-JCM-1616	32450-1616	20243980	1	1 3/8-12	1 3/8	1.62	41.3	3.94	100.1



Download the **MyCrimp App** for more information.

Section 7
TP Fittings





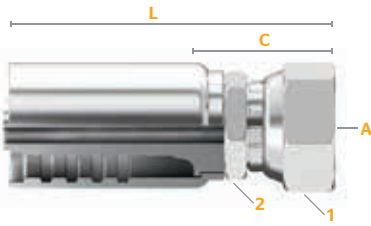

FITTINGS





SAE 45° J512 Flare





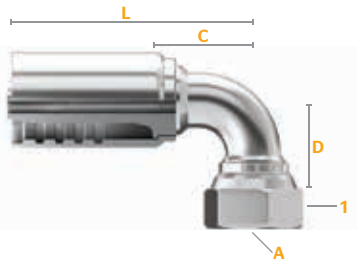

Female / Swivel

Part Number	Product Number	SAP Number								
			Hose ID	Thread Size (A)	Hex 1 Wrench Size	Hex 2 Wrench Size	Cut-Off (C)		Length (L)	
			in.		mm	mm	in.	mm	in.	mm
T7-SFFX-0404	32775-0404	20244137	1/4	7/16-20	5/8	5/8	1.44	36.5	2.53	64.3
T8-SFFX-0404	34775-0404	20244136	1/4	7/16-20	5/8	5/8	1.45	36.7	2.53	64.3
T7-SFFX-0405	32775-0405	20244140	1/4	1/2-20	3/4	5/8	1.45	36.7	2.53	64.3
T8-SFFX-0405	34775-0405	20244139	1/4	1/2-20	3/4	5/8	1.45	36.7	2.53	64.3
T7-SFFX-0406	32775-0406	20244138	1/4	5/8-18	13/16	5/8	1.44	36.5	2.53	64.3
T8-SFFX-0406	34775-0406	20244145	1/4	5/8-18	13/16	5/8	1.44	36.5	2.53	64.3
T7-SFFX-0506	32775-0506	20244132	5/16	5/8-18	13/16	5/8	1.25	31.8	2.53	64.3
T7-SFFX-0606	32775-0606	20244134	3/8	5/8-18	13/16	3/4	1.38	34.9	2.81	71.5
T8-SFFX-0606	34775-0606	20244133	3/8	5/8-18	13/16	3/4	1.38	34.9	2.81	71.5
T7-SFFX-0808	32775-0808	20244142	1/2	3/4-16	15/16	7/8	1.66	42.1	3.15	80.0
T8-SFFX-0808	34775-0808	20244141	1/2	3/4-16	15/16	7/8	1.66	42.1	3.15	80.0
T7-SFFX-1212	32775-1212	20244135	3/4	1 1/8-14	1 1/4	1 1/8	1.62	41.3	3.44	87.3



SAE 45° J512 Flare

Female / 90° Elbow / Swivel

Part Number	Product Number	SAP Number										
			Hose ID	Thread Size (A)	Hex 1 Wrench Size	Hex 2 Wrench Size	Drop (D)	Cut-Off (C)		Length (L)		
			in.		mm	mm	in.	mm	in.	mm		
T7-SFFX90-0606	32780-0606	20244144	3/8	5/8-18	3/4	3/4	1.12	28.6	1.19	30.2	2.63	66.8
T8-SFFX90-0606	34780-0606	20244143	3/8	5/8-18	3/4	3/4	1.12	28.6	1.19	30.2	2.63	66.8

FITTINGS



Section 7

TP Fittings

COMPATIBLE HOSE:





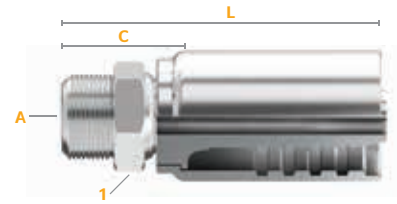

SR7 NR7 SR8 NR8
 TR7 BR7 TR8 SR18

For a detailed list, please refer to your Crimp Specifications Manual.

SAE 45° Inverted Flare

Male / Swivel







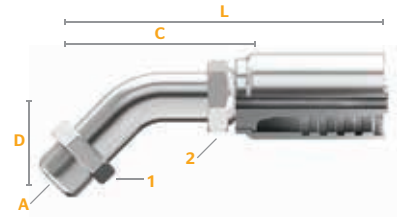

Part Number	Product Number	SAP Number								
			Hose ID	Thread Size (A)	Hex 1 Wrench Size	Hex 2 Wrench Size	Cut-Off (C)	Length (L)	in.	mm
T7-SIMX-0404	32800-0404	20244127	in.		mm	mm	in.	mm	in.	mm
T7-SIMX-0405	32800-0405	20244128	1/4	7/16-24	7/16	5/8	1.64	41.6	2.72	69.1
T7-SIMX-0405	32800-0405	20244128	1/4	1/2-20	1/2	5/8	1.69	42.9	2.78	70.6

SAE 45° Inverted Flare

Male / 45° Elbow / Swivel







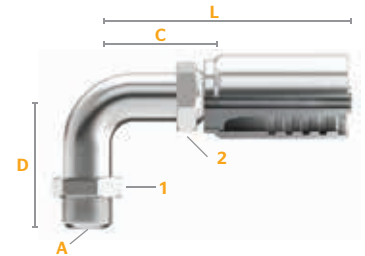

Part Number	Product Number	SAP Number										
			Hose ID	Thread Size (A)	Hex 1 Wrench Size	Hex 2 Wrench Size	Drop (D)	Cut-Off (C)	Length (L)	in.	mm	in.
T8-SIMX45-0606	34810-0606	20244130	in.		mm	mm	in.	mm	in.	mm	in.	mm
T8-SIMX45-0606	34810-0606	20244130	3/8	5/8-18	5/8	3/4	0.96	24.5	1.88	47.6	3.30	83.8

SAE 45° Inverted Flare

Male / 90° Elbow / Swivel



Part Number	Product Number	SAP Number										
			Hose ID	Thread Size (A)	Hex 1 Wrench Size	Hex 2 Wrench Size	Drop (D)	Cut-Off (C)	Length (L)	in.	mm	in.
T7-SIMX90-0404	32815-0404	20244129	1/4	7/16-24	7/16	9/16	1.31	33.3	1.23	31.3	2.31	58.7
T7-SIMX90-0606	32815-0606	20244131	3/8	5/8-18	5/8	3/4	1.66	42.2	1.19	30.2	2.62	66.7
T8-SIMX90-0606	34815-0606	20244126	3/8	5/8-18	5/8	3/4	1.66	42.2	1.19	30.2	2.63	66.8



Download the **MyCrimp App** for more information.

Section 7
TP Fittings

FITTINGS

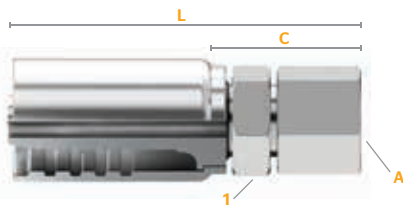

**NPTF**

Female

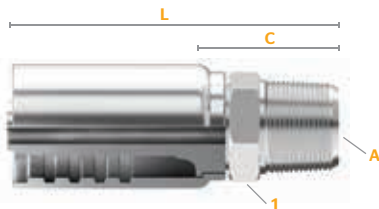

Part Number	Product Number	SAP Number	Hose ID		Thread Size (A)		Hex 1 Wrench Size		Cut-Off (C)		Length (L)	
			in.	mm	in.	mm	in.	mm	in.	mm		
T7-NPF-0404	32600-0404	20244060	1/4	1/4	1/4-18	3/4	1.25	31.8	2.34	59.5		
T8-NPF-0404	34600-0404	20244059	1/4	1/4	1/4-18	3/4	1.25	31.8	2.34	59.5		
T7-NPF-0604	32600-0604	20244058	3/8	3/8	1/4-18	3/4	1.06	27.0	2.53	64.3		
T7-NPF-0606	32600-0606	20244057	3/8	3/8	3/8-18	7/8	1.19	30.2	2.63	66.7		
T8-NPF-0606	34600-0606	20244056	3/8	3/8	3/8-18	7/8	1.19	30.2	2.63	66.7		
T7-NPF-0808	32600-0808	20244062	1/2	1/2	1/2-14	1 1/16	1.31	33.3	3.03	77.0		
T8-NPF-0808	34600-0808	20244061	1/2	1/2	1/2-14	1 1/16	1.31	33.3	3.03	77.0		

**NPTF**

Male



Part Number	Product Number	SAP Number	Hose ID		Thread Size (A)		Hex 1 Wrench Size		Cut-Off (C)		Length (L)	
			in.	mm	in.	mm	in.	mm	in.	mm		
T7-NPM-0202	32615-0202	20244064	1/8	1/8	1/8-27	1/2	0.75	19.1	1.34	34.1		
T7-NPM-0302	32615-0302	20244065	3/16	3/16	1/8-27	9/16	1.06	27.0	1.88	47.8		
T8-NPM-0302	34615-0302	20244055	3/16	3/16	1/8-27	9/16	1.06	27.0	1.88	47.8		
T7-NPM-0304	32615-0304	20244067	3/16	3/16	1/4-18	11/16	1.25	31.8	2.06	52.3		
T8-NPM-0304	34615-0304	20244066	3/16	3/16	1/4-18	11/16	1.25	31.8	2.06	52.3		
T7-NPM-0306	32615-0306	20244052	3/16	3/16	3/8-18	3/4	1.38	34.9	2.15	54.7		
T8-NPM-0306	34615-0306	20244038	3/16	3/16	3/8-18	3/4	1.38	34.9	2.15	54.7		
T7-NPM-0402	32615-0402	20244072	1/4	1/4	1/8-27	5/8	1.06	27.0	2.13	54.1		
T8-NPM-0402	34615-0402	20244071	1/4	1/4	1/8-27	5/8	1.06	27.0	2.13	54.1		
T7-NPM-0404	32615-0404	20244078	1/4	1/4	1/4-18	11/16	1.25	31.8	2.31	58.7		
T8-NPM-0404	34615-0404	20244079	1/4	1/4	1/4-18	11/16	1.25	31.8	2.31	58.7		
T8-NPM-0404S	34615-0404S	20435885	1/4	1/4	1/4-18	11/16	1.25	31.8	2.31	58.7		
T7-NPM-0406	32615-0406	20244070	1/4	1/4	3/8-18	3/4	1.31	33.3	2.40	61.1		
T8-NPM-0406	34615-0406	20244069	1/4	1/4	3/8-18	3/4	1.31	33.3	2.40	61.1		
T7-NPM-0408	32615-0408	20244076	1/4	1/4	1/2-14	15/16	1.56	39.7	2.66	67.5		
T8-NPM-0408	34615-0408	20244077	1/4	1/4	1/2-14	15/16	1.56	39.7	2.66	67.5		

Continued on the next page.

FITTINGS**Section 7**

TP Fittings

COMPATIBLE HOSE:

SR7	NR7	SR8	NR8
TR7	BR7	TR8	SR18

For a detailed list, please refer to your Crimp Specifications Manual.

NPTF (Male) Continued

Part Number	Product Number	SAP Number	Hose ID	Thread Size (A)	Hex 1 Wrench Size	Cut-Off (C)		Length (L)	
						in.	mm	in.	mm
T7-NPM-0504	32615-0504	20244032	5/16	1/4-18	11/16	1.12	28.6	2.31	58.8
T7-NPM-0604	32615-0604	20244033	3/8	1/4-18	3/4	1.31	33.3	2.59	65.8
T8-NPM-0604	34615-0604	20244030	3/8	1/4-18	3/4	1.31	33.3	2.59	65.8
T7-NPM-0606	32615-0606	20244028	3/8	3/8-18	3/4	1.31	33.3	2.59	65.8
T8-NPM-0606	34615-0606	20244029	3/8	3/8-18	3/4	1.31	33.3	2.59	65.8
T7-NPM-0608	32615-0608	20244031	3/8	1/2-14	15/16	1.56	39.7	2.84	72.2
T8-NPM-0608	34615-0608	20244035	3/8	1/2-14	15/16	1.56	39.7	2.84	72.2
T7-NPM-0806	32615-0806	20244073	1/2	3/8-18	7/8	1.28	32.5	2.78	70.7
T8-NPM-0806	34615-0806	20244075	1/2	3/8-18	7/8	1.25	31.8	2.78	70.7
T7-NPM-0808	32615-0808	20244054	1/2	1/2-14	15/16	1.50	38.1	3.03	77.0
T8-NPM-0808	34615-0808	20244053	1/2	1/2-14	15/16	1.50	38.1	3.03	77.0
T7-NPM-0812	32615-0812	20244068	1/2	3/4-14	1 1/8	1.50	38.1	3.04	77.1
T8-NPM-0812	34615-0812	20244074	1/2	3/4-14	1 1/8	1.50	38.1	3.09	78.6
T7-NPM-1208	32615-1208	20244037	3/4	1/2-14	1 1/8	1.44	36.5	3.22	81.8
T7-NPM-1212	32615-1212	20244036	3/4	3/4-14	1 1/8	1.38	34.9	3.22	81.8
T8-NPM-1212	34615-1212	20440323	3/4	3/4-14	1 1/8	1.63	41.3	3.21	81.5
T7-NPM-1616	32615-1616	20244063	1	1-11 1/2	1 3/8	1.62	41.3	3.97	100.8
T8-NPM-1616	34615-1616	20440324	1	1-11 1/2	1 3/8	1.88	47.6	3.97	100.8

S=Stainless Steel (See Fitting Identification in Appendix for more information.)



Download the **MyCrimp App**
for more information.

Section 7

TP Fittings

FITTINGS



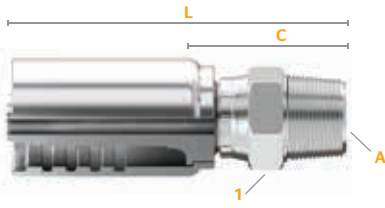

NPTF

Male / Swivel

Part Number	Product Number	SAP Number	Hose ID	Thread Size (A)	Hex 1	Hex 2	Cut-Off (C)		Length (L)	
					Wrench Size	Wrench Size	in.	mm	in.	mm
T7-NPMX-0202	32645-0202	20598101	1/8	1/8-27	1/2	1/2	1.33	33.8	1.90	48.2
T7-NPMX-0304	32645-0304	20244047	3/16	1/4-18	11/16	5/8	1.81	46.0	2.64	67.0
T8-NPMX-0304	34645-0304	20244039	3/16	1/4-18	11/16	5/8	1.81	46.0	2.64	67.0
T7-NPMX-0404	32645-0404	20244050	1/4	1/4-18	11/16	5/8	1.81	46.0	2.87	73.0
T8-NPMX-0404	34645-0404	20244049	1/4	1/4-18	11/16	5/8	1.81	46.0	2.87	73.0
T7-NPMX-0406	32645-0406	20244048	1/4	3/8-18	3/4	5/8	1.93	49.0	3.02	76.7
T7-NPMX-0504	32645-0504	20244040	5/16	1/4-18	11/16	5/8	1.62	41.3	2.87	73.0
T7-NPMX-0606	32645-0606	20244042	3/8	3/8-18	3/4	3/4	1.69	42.9	3.15	80.0
T8-NPMX-0606	34645-0606	20244041	3/8	3/8-18	3/4	3/4	1.69	42.9	3.15	80.0
T7-NPMX-0608	32645-0608	20244044	3/8	1/2-14	7/8	3/4	1.88	47.6	3.38	85.7
T8-NPMX-0608	34645-0608	20244043	3/8	1/2-14	7/8	3/4	1.88	47.6	3.31	84.2
T7-NPMX-0808	32645-0808	20244045	1/2	1/2-14	15/16	7/8	1.94	49.2	3.61	91.7
T8-NPMX-0808	34645-0808	20244051	1/2	1/2-14	15/16	7/8	1.94	49.2	3.61	91.7
T7-NPMX-1212	32645-1212	20244046	3/4	3/4-14	1 1/2	1 1/2	2.00	50.8	3.84	97.5
T7-NPMX-1616	32645-1616	20244034	1	1-11 1/2	1 1/2	1 3/4	2.31	58.7	4.65	118.1

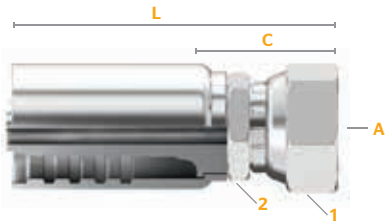

NPSM

Female / Swivel

Part Number	Product Number	SAP Number	Hose ID	Thread Size (A)	Hex 1	Hex 2	Cut-Off (C)		Length (L)	
					Wrench Size	Wrench Size	in.	mm	in.	mm
T7-NSFX-0808	32655-0808	20244026	1/2	1/2-14	1	1	1.38	34.9	3.06	77.8
T8-NSFX-0808	34655-0808	20244027	1/2	1/2-14	1	1	1.38	34.9	3.06	77.8

FITTINGS



Section 7

TP Fittings

COMPATIBLE HOSE:





SR7 NR7 SR8 NR8
TR7 BR7 TR8 SR18

For a detailed list, please refer to your Crimp Specifications Manual.

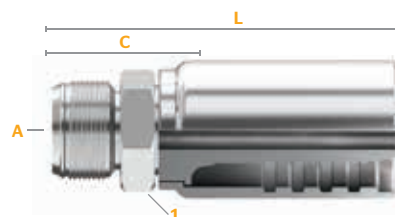
SAE J514 Flareless Tube Fittings

Male







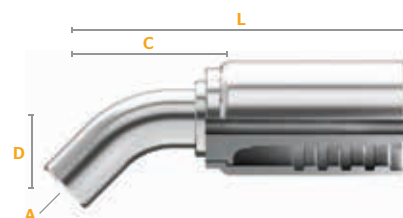

Part Number	Product Number	SAP Number							
			Hose ID	Thread Size (A)	Hex 1 Wrench Size	Cut-Off (C)	Length (L)	in.	mm
T7-FTM-0606	32360-0606	20244148	in.		mm	in.	mm	in.	mm
T7-FTM-0606	32360-0606	20244148	3/8	9/16-18	3/4	1.06	27.0	2.50	63.4
T8-FTM-0606	34360-0606	20244147	3/8	9/16-18	3/4	1.06	26.9	2.50	63.5
T7-FTM-0808	32360-0808	20244146	1/2	3/4-16	7/8	1.16	29.4	2.78	70.6

Standpipe

45° Elbow



Part Number	Product Number	SAP Number									
			Hose ID	Thread Size (A)	Hex 1 Wrench Size	Drop (D)	Cut-Off (C)	Length (L)	in.	mm	
T7-SP45-0408	32830-0408	20244149	in.		mm	in.	mm	in.	mm	in.	mm
T7-SP45-0408	32830-0408	20244149	1/4	8	5/8	0.75	19.0	1.77	45.0	2.80	71.0
T8-SP45-0408	34830-0408	20244150	1/4	8	5/8	0.75	19.0	1.77	45.0	2.80	71.0



Download the **MyCrimp App** for more information.

Section 7
TP Fittings





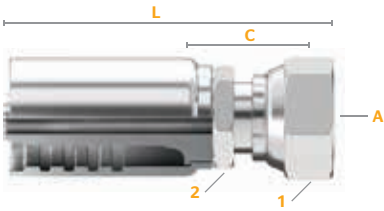

FITTINGS





O-Ring Face Seal (SAE J1453 ORS/ORFS)





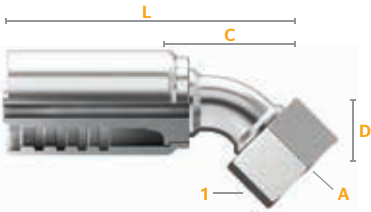

Female / Swivel

Part Number	Product Number	SAP Number	     		Hose ID	Thread Size (A)	Hex 1 Wrench Size	Hex 2 Wrench Size	Cut-Off (C)		Length (L)	
			in.	mm					in.	mm	in.	mm
T7-OFFX-0404	32700-0404	20244101	1/4	9/16-18	11/16	5/8	1.50	38.1	2.60	66.0		
T8-OFFX-0404	34700-0404	20244105	1/4	9/16-18	11/16	5/8	1.50	38.1	2.60	66.0		
T7-OFFX-0506	32700-0506	20244108	5/16	11/16-16	13/16	5/8	1.56	39.7	2.74	69.7		
T7-OFFX-0606	32700-0606	20244103	3/8	11/16-16	7/8	3/4	1.44	36.5	2.75	69.9		
T8-OFFX-0606	34700-0606	20244106	3/8	11/16-16	7/8	3/4	1.44	36.5	2.75	69.9		
T7-OFFX-0608	32700-0608	20244107	3/8	13/16-16	15/16	3/4	1.88	47.6	3.22	81.8		
T7-OFFX-0808	32700-0808	20244097	1/2	13/16-16	15/16	7/8	1.56	39.7	3.12	79.4		
T8-OFFX-0808	34700-0808	20244098	1/2	13/16-16	15/16	7/8	1.69	42.9	3.28	83.4		
T8-OFFX-0810	34700-0810	20244096	1/2	1-14	1 1/8	7/8	1.88	47.6	3.39	86.1		
T7-OFFX-1212	32700-1212	20244104	3/4	1 3/16 - 12	1 3/8	1 1/2	2.12	54.0	3.88	98.7		
T7-OFFX-1616	32700-1616	20244095	1	1 3/16 - 12	1 3/8	1 3/4	2.12	54.0	4.36	110.7		



O-Ring Face Seal (SAE J1453 ORS/ORFS)

Female / 45° Elbow / Swivel

Part Number	Product Number	SAP Number	      		Hose ID	Thread Size (A)	Hex 1 Wrench Size	Hex 2 Wrench Size	Drop (D)		Cut-Off (C)		Length (L)	
			in.	mm					in.	mm	in.	mm	in.	mm
T7-OFFX45-0404	32710-0404	20244116	1/4	9/16-18	11/16	5/8	0.41	10.4	1.50	38.1	2.55	64.8		
T8-OFFX45-0404	34710-0404	20244117	1/4	9/16-18	11/16	5/8	0.41	10.4	1.50	38.1	2.55	64.8		
T7-OFFX45-0506	32710-0506	20244111	5/16	11/16-16	13/16	5/8	0.43	10.9	1.50	38.1	2.63	66.9		
T7-OFFX45-0606	32710-0606	20244109	3/8	11/16-16	13/16	3/4	0.43	10.9	1.50	38.1	2.82	71.8		
T8-OFFX45-0606	34710-0606	20244110	3/8	11/16-16	13/16	3/4	0.43	10.9	1.50	38.1	2.82	71.8		
T7-OFFX45-0608	32710-0608	20268564	3/8	13/16-16	15/16	3/4	0.47	11.9	1.65	41.9	3.12	79.2		
T7-OFFX45-0808	32710-0808	20244115	1/2	13/16-16	15/16	7/8	0.59	15.0	1.75	44.5	3.32	84.2		
T8-OFFX45-0808	34710-0808	20244114	1/2	13/16-16	15/16	7/8	0.59	15.0	1.75	44.5	3.32	84.2		

O-Ring Face Seal (SAE J1453 ORS/ORFS)

Female / 90° Elbow / Swivel

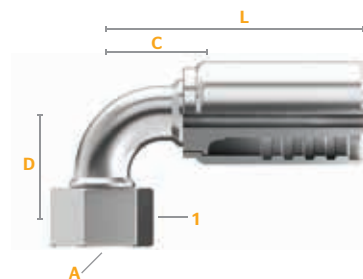

Part Number	Product Number	SAP Number											
			Hose ID	Thread Size (A)	Hex 1 Wrench Size	Hex 2 Wrench Size	Elbow Type*	Drop (D)	Cut-Off (C)	Length (L)			
			in.		in.	in.	in.	mm	in.	mm	in.	mm	
T7-OFFX90-0404	32715-0404	20244118	1/4	9/16-18	11/16	5/8		0.78	19.8	1.25	31.8	2.31	58.8
T8-OFFX90-0404	34715-0404	20244123	1/4	9/16-18	11/16	5/8		0.78	19.8	1.25	31.8	2.31	58.8
T7-OFFX90-0506	32715-0506	20244100	5/16	11/16-16	13/16	3/4		0.90	22.9	1.94	49.2	3.10	78.7
T7-OFFX90-0606	32715-0606	20244119	3/8	11/16-16	13/16	3/4		0.90	22.9	2.00	50.8	3.30	83.8
T8-OFFX90-0606	34715-0606	20244120	3/8	11/16-16	13/16	3/4		0.90	22.9	2.00	50.8	3.30	83.8
T7-OFFX90L-0606	32720-0606	20244121	3/8	11/16-16	13/16	3/4	LT	2.13	54.1	1.44	36.5	2.74	69.6
T8-OFFX90L-0606	34720-0606	20244122	3/8	11/16-16	13/16	3/4	LT	2.13	54.1	1.44	36.5	2.74	69.6
T7-OFFX90-0808	32715-0808	20244124	1/2	13/16-16	15/16	7/8		1.15	29.2	1.50	38.1	3.04	77.3
T8-OFFX90-0808	34715-0808	20244125	1/2	13/16-16	15/16	7/8		1.15	29.2	1.50	38.1	3.04	77.3
T7-OFFX90L-0808	32720-0808	20244112	1/2	13/16-16	15/16	7/8	LT	2.51	63.8	1.56	39.7	3.16	80.3
T8-OFFX90L-0808	34720-0808	20244113	1/2	13/16-16	15/16	7/8	LT	2.51	63.8	1.56	39.7	3.16	80.3

*Elbow Type: LT=Long Tube

O-Ring Face Seal (SAE J1453 ORS/ORFS)

Male

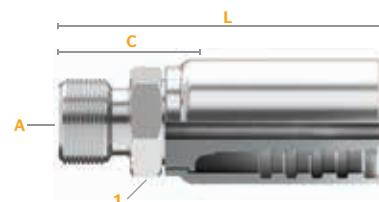

Part Number	Product Number	SAP Number							
			Hose ID	Thread Size (A)	Hex 1 Wrench Size	Cut-Off (C)	Length (L)		
			in.		mm	in.	mm	in.	mm
T7-OFM-0404	32730-0404	20244102	1/4	9/16-18	5/8	1.06	27.0	2.13	54.1



Download the **MyCrimp App** for more information.

Section 7
TP Fittings



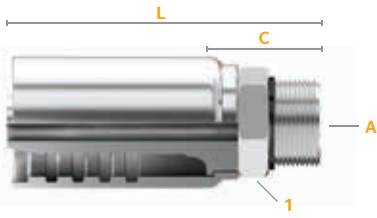

FITTINGS





O-Ring Boss Straight Thread (SAE J514)



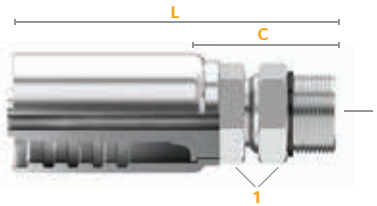

Male

Part Number	Product Number	SAP Number							
			Hose ID	Thread Size (A)	Hex 1 Wrench Size	Cut-Off (C)		Length (L)	
			in.		mm	in.	mm	in.	mm
T7-OBM-0406	32670-0406	20244092	1/4	9/16-18	11/16	1.06	27.0	2.14	54.4
T8-OBM-0406	34670-0406	20244093	1/4	9/16-18	11/16	1.06	27.0	2.14	54.4
T7-OBM-0606	32670-0606	20244083	3/8	9/16-18	3/4	1.00	25.4	2.42	61.5
T8-OBM-0606	34670-0606	20244084	3/8	9/16-18	3/4	1.00	25.4	2.42	61.5
T7-OBM-0608	32670-0608	20244081	3/8	3/4-16	7/8	1.03	26.2	2.47	62.7
T8-OBM-0608	34670-0608	20244082	3/8	3/4-16	7/8	1.03	26.2	2.47	62.7
T7-OBM-0808	32670-0808	20244090	1/2	3/4-16	15/16	1.09	27.8	2.78	70.7
T8-OBM-0808	34670-0808	20244091	1/2	3/4-16	15/16	1.09	27.8	2.78	70.7



O-Ring Boss Straight Thread (SAE J514)

Male / Swivel

Part Number	Product Number	SAP Number							
			Hose ID	Thread Size (A)	Hex 1 Wrench Size	Cut-Off (C)		Length (L)	
			in.		mm	in.	mm	in.	mm
T7-OBMX-0606	32680-0606	20244080	3/8	9/16-18	3/4	1.50	38.1	2.97	75.4
T8-OBMX-0606	34680-0606	20244086	3/8	9/16-18	3/4	1.50	38.1	2.97	75.4

O-Ring Boss Straight Thread (SAE J514)

Male / 90° Block Elbow / Swivel

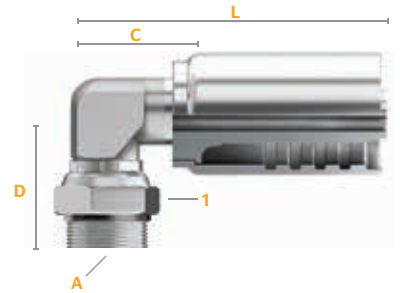

Part Number	Product Number	SAP Number											
			Hose ID	Thread Size (A)	Hex 1 Wrench Size	Hex 2 Wrench Size	Elbow Type ¹	Drop (D)	Cut-Off (C)	Length (L)			
			in.		in.	in.		in.	mm	in.	mm	in.	mm
T7-OBMX90B-0608	32685-0608	20244088	3/8	3/4-16	7/8	13/16	BE	1.11	28.1	0.88	22.2	2.63	66.8
T8-OBMX90B-0608	34685-0608	20244094	3/8	3/4-16	7/8	13/16	BE	1.11	28.1	0.88	22.2	2.63	66.8

¹Elbow Type: BE=Block Elbow

BSPB (British Standard Pipe Parallel)

Female / Swivel

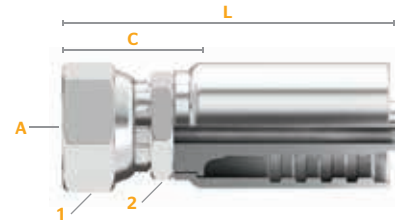

Part Number	Product Number	SAP Number										
			Hose ID	Thread Size (A)	Hex 1 Wrench Size	Hex 2 Wrench Size	Cut-Off (C)	Length (L)				
			in.		in.	mm	in.	mm	in.	mm		
T7-BPFX-0404	32105-0404	20243906	1/4	1/4-19	3/4	19	9/16	14	1.29	32.8	2.31	58.8
T8-BPFX-0404	34105-0404	20243903	1/4	1/4-19	3/4	19	9/16	14	1.29	32.8	2.31	58.8
T7-BPFX-0606	32105-0606	20243907	3/8	3/8-19	7/8	22	11/16	17	1.41	35.8	2.67	67.8
T8-BPFX-0606	34105-0606	20243908	3/8	3/8-19	7/8	22	11/16	17	1.41	35.8	2.67	67.8
T7-BPFX-0608	32105-0608	20243902	3/8	1/2-14	1 1/8	27	23/32	18	1.59	40.5	2.85	72.5
T8-BPFX-0608	34105-0608	20243901	3/8	1/2-14	1 1/8	27	23/32	18	1.59	40.5	2.85	72.5
T7-BPFX-0806	32105-0806	20243904	1/2	5/8-14	7/8	22	1 1/4	22	1.74	44.1	3.23	82.1
T8-BPFX-0806	34105-0806	20243900	1/2	5/8-14	7/8	22	1 1/4	22	1.74	44.1	3.23	82.1
T7-BPFX-0808	32105-0808	20243909	1/2	1/2-14	1 1/8	27	1 1/4	22	1.55	39.4	3.05	77.4
T8-BPFX-0808	34105-0808	20243905	1/2	1/2-14	1 1/8	27	1 1/4	22	1.55	39.4	3.05	77.4
T7-BPFX-1616	32105-1616	20243910	1	1-11	1 3/8	41	1 1/8	36	1.76	44.7	4.00	101.7



Download the **MyCrimp App** for more information.

Section 7
TP Fittings

FITTINGS



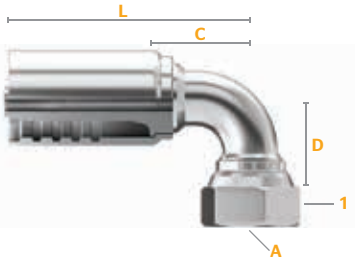

BSPP (British Standard Pipe Parallel)

Female / 90° Elbow / Swivel

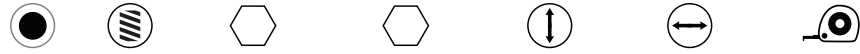

Part Number	Product Number	SAP Number	Hose ID		Thread Size (A)		Hex 1 Wrench Size		Hex 2 Wrench Size		Drop (D)		Cut-Off (C)		Length (L)	
			in.	mm	in.	mm	in.	mm	in.	mm	in.	mm	in.	mm		
T7-BPFX90-0606	32120-0606	20243911	3/8		3/8-19	7/8	22	11/16	17	1.50	38.0	1.57	40.0	2.83	72.0	
T8-BPFX90-0606	34120-0606	20243914	3/8		3/8-19	7/8	22	11/16	17	1.50	38.0	1.57	40.0	2.83	72.0	
T8-BPFX90-0808	34120-0808	20243912	1/2		1/2-14	1 1/8	27	7/8	22	1.67	42.5	1.65	42.0	3.15	80.0	

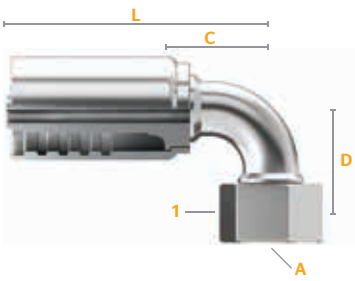

DIN 60°

Female / 90° Elbow / Swivel

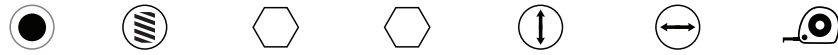

Part Number	Product Number	SAP Number	Hose ID		Thread Size (A)		Hex 1 Wrench Size		Hex 2 Wrench Size		Drop (D)		Cut-Off (C)		Length (L)	
			in.	mm	mm	mm	in.	mm	in.	mm	in.	mm	in.	mm		
T8-DNFX90-0418	34280-0418	20243915	1/4		18x15	22	17	1.40	35.5	1.30	33.0	2.32	59.0			

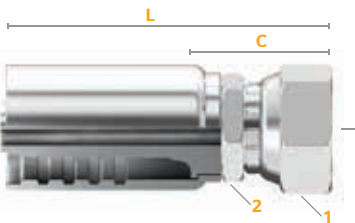

JIS 30° (Parallel Pipe Threads)

Female / Swivel



Part Number	Product Number	SAP Number	Hose ID		Thread Size (A)		Hex 1 Wrench Size		Hex 2 Wrench Size		Cut-Off (C)		Length (L)	
			in.	mm	in.	mm	in.	mm	in.	mm	in.	mm		
T7-JSFX-0404	32520-0404	20244023	1/4		1/4-19	3/4	19	13/16	19	1.38	34.9	2.46	62.6	
T8-JSFX-0404	34520-0404	20244020	1/4		1/4-19	3/4	19	13/16	19	1.38	34.9	2.46	62.6	
T7-JSFX-0606	32520-0606	20244022	3/8		3/8-19	7/8	22	7/8	22	1.56	39.7	2.82	71.6	
T8-JSFX-0606	34520-0606	20244021	3/8		3/8-19	7/8	22	7/8	22	1.56	39.7	2.82	71.6	
T7-JSFX-0808	32520-0808	20244025	1/2		1/2-14	1 1/8	27	7/8	22	1.69	42.9	3.32	84.4	
T8-JSFX-0808	34520-0808	20244024	1/2		1/2-14	1 1/8	27	7/8	22	1.69	42.9	3.32	84.4	

FITTINGS



Section 7

TP Fittings

COMPATIBLE HOSE:

- SR7
- NR7
- SR8
- NR8
- TR7
- BR7
- TR8
- SR18

For a detailed list, please refer to your Crimp Specifications Manual.

SECTION 8 - AC FITTINGS

This section lists all fittings compatible with the following hose:

Hose	Description
G4826	Air Conditioning (Galaxy®)
G4867	Air Conditioning (Galaxy®)
G4890	Air Conditioning (Galaxy®)

How to Use the Fittings Table

The fittings in this section will follow a similar table structure to the one seen on this page.

Fitting dimensions and attributes are explained below.

COMPATIBLE HOSE

COMPATIBLE HOSE - The Continental hose compatible with each fitting in this section is shown at the top of every page. Be sure to only use those fittings shown for the hose families listed.

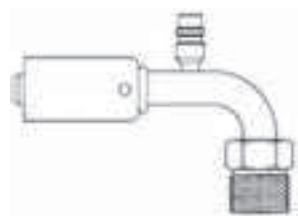

Fitting Name

Fitting Description

Part Number	Product Number	SAP Number	Hose ID		Drop (D)		Cut-Off (R)		Valve (V)	
			in.	mm	in.	mm	in.	mm	in.	mm
AC-OIM134V90-0606	50535-0606	20307019	5/16	12.7	1.61	41	2.13	54	0.63	16
AC-OIM134V90-0808	50535-0808	20307020	13/32	10.4	1.89	48	2.13	54	0.63	16
AC-OIM134V90-1010	50535-1010	20307021	1/2	12.7	2.13	54	2.36	60	0.51	13

Fitting Dimensions and Attributes

Part Number See Hydraulic Fittings Nomenclature on page 128 for a breakdown of part number attributes

Hose ID The compatible Hose ID

Thread Size The thread size or sizes available for a particular fitting dash size (indicated by **A** in the fitting image)

Drop The length of the elbow

Cut-Off The amount of hose to be cut for a correct assembly length (indicated by **C** in the fitting image)

Choose fittings carefully, considering the working pressure of both the hose and fitting. The maximum working pressure of the hose assembly is the lesser of the rated working pressure of the hose and the fitting. See page 389 for the Fittings Working Pressure Guide.



Download the **MyCrimp App** for more information.

Section 8
AC Fittings

FITTINGS



AC Fittings Nomenclature

Cool Clip® Fitting Style	Family	Fitting Family Description	Gender	Swivel	Valve	Attribute
CB12VS	CB	Compressor Pad Block			R12	S = Single
CB12VSR	CB				R12	SR = Single Reversed
COTF	COT	Compressor O-Ring Tube	F	Yes		
COTF134V	COT		F	Yes	R134a	
FTBO	FT	Flareless Tube				BO = Braze On
FTM	FT		M			
FTMM	FT		M			M = Metric
FTN	FT					N = Nut
FTS	FT					S = Sleeve
FTSM	FT					S = Sleeve, M = Metric
FSLF	FSL	Ford Spring Lock	F			
FSLM	FSL		M			
HM	HM	Hose Mender				
HM12V	HM				R12	
HM134V	HM				R134a	
HMSG	HM					SG = Sight Glass
HMT	HM				T = Tee	
ILOTORA	ILOT	Inline Orifice Tube				ORA = Orange
ILOTRED	ILOT					RED = Red
ILOTBLU	ILOT					BLU = Blue
ILOTBLK	ILOT					BLK = Black
ILOTWHI	ILOT					WHI = White
OFFX	OF	O-Ring Face Seal (SAE J1453 ORS/ORFS)	F	X		
OIM	OI	O-Ring Insert	M			
OIMB	OI		M			B = Bulkhead
OIM134V	OI		M		R134a	
OTF	OT	O-Ring Tube	F	Yes		
OTF12V	OT		F	Yes	R12	
OTF134V	OT		F	Yes	R134a	
OTF134VHS	OT		F	Yes	R134a	HS = High Pressure Side
OTM	OT		M	Yes		
OTMLP	OT		M	Yes		LP = Long Pilot
OTM134V	OT		M	Yes	R134a	
SFFX	SF	SAE 45° J512 Flare	F	X		
SFM	SF		M			
SWA	SW	Sealing Washer				A = Accumulator
SWCN	SW					CN = Compressor Narrow
SWCW	SW					CW = Compressor Wide
VC12V	VC	Valve Cap			R12	
VC134VHS	VC				R134a	HS = High Pressure Side
VC134VLS	VC				R134a	LS = Low Pressure Side

Additional Prefix & Suffix

45 = 45° Elbow	90 = 90° Elbow	180 = 180° Elbow
45B = 45° Block Elbow	90B = 90° Block Elbow	134V = R134a Valve
		A = Aluminum

Example Part Number: GC-OTF134V45

OTF =	O-Ring Tube Female
134V =	134a Valve
45 =	45° Elbow



FITTINGS



Section 8

AC Fittings













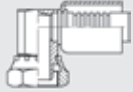
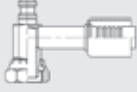







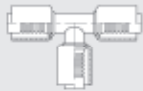
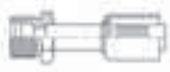



COMPATIBLE HOSE:

G4826 G4867 G4890

For a detailed list, please refer to your Crimp Specifications Manual.

AC Fittings Overview

AC (Cool Crimp™) Fittings

<p>Compressor O-Ring Tube Female 45° Elbow</p>  <p>AC-COTF45 P. 310</p>	<p>Compressor O-Ring Tube Female 90° Elbow</p>  <p>AC-COTF90 P. 310</p>	<p>Compressor O-Ring Tube Female 90° Block Elbow</p>  <p>AC-COTF90B P. 310</p>	<p>Compressor O-Ring Tube Female 90° Block Elbow R134a Valve</p>  <p>AC-COTF134V90B P. 311</p>
<p>Flareless Tube</p>  <p>AC-FTM P. 311</p>	<p>Flareless Tube Male 90° Block Elbow</p>  <p>AC-FTM90B P. 312</p>	<p>Flareless Tube Male Metric</p>  <p>AC-FTMM P. 312</p>	<p>Hose Mender</p>  <p>AC-HM P. 313</p>
<p>Hose Mender 90° Elbow</p>  <p>AC-HM90 P. 313</p>	<p>Hose Mender R12 Valve</p>  <p>AC-HM12V P. 314</p>	<p>Hose Mender R134a Valve</p>  <p>AC-HM134V P. 314</p>	<p>Hose Mender with Sight Glass R134a Valve</p>  <p>HMSG P. 314</p>
<p>Hose Mender, Tee</p>  <p>AC-HMT P. 315</p>	<p>O-Ring Insert Male</p>  <p>AC-OIM P. 315</p>	<p>O-Ring Insert Male 45° Elbow</p>  <p>AC-OIM45 P. 316</p>	<p>O-Ring Insert Male 90° Elbow</p>  <p>AC-OIM90 P. 316</p>
<p>O-Ring Insert Male Bulkhead</p>  <p>AC-OIMB P. 317</p>	<p>O-Ring Insert Male Bulkhead 90° Elbow</p>  <p>AC-OIMB90 P. 317</p>	<p>O-Ring Insert Male R134a Valve</p>  <p>AC-OIM134V P. 317</p>	<p>O-Ring Insert Male 90° Elbow R134a Valve</p>  <p>AC-OIM134V90 P. 318</p>
<p>O-Ring Tube Female Swivel</p>  <p>AC-OTF P. 318</p>	<p>O-Ring Tube Female 45° Elbow Swivel</p>  <p>AC-OTF45 P. 319</p>	<p>O-Ring Tube Female 90° Elbow Swivel</p>  <p>AC-OTF90 P. 319</p>	<p>O-Ring Tube Female 90° Block Elbow Swivel</p>  <p>AC-OTF90B P. 320</p>
<p>O-Ring Tube Female 180° Elbow Swivel</p>  <p>AC-OTF180 P. 320</p>	<p>O-Ring Tube Female Swivel Metric</p>  <p>AC-OTFM P. 321</p>	<p>O-Ring Tube Female 45° Elbow Swivel Metric</p>  <p>AC-OTFM45 P. 321</p>	<p>O-Ring Tube Female 90° Elbow Swivel Metric</p>  <p>AC-OTFM90 P. 322</p>



Download the **MyCrimp App** for more information.











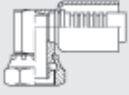

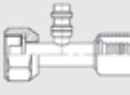

Section 8
AC Fittings

FITTINGS



AC Fittings Overview

AC (Cool Crimp™) Fittings

<p>O-Ring Tube Female Swivel R12 Valve</p>  <p>AC-OTF12V P. 322</p>	<p>O-Ring Tube Female 90° Elbow Swivel R12 Valve</p>  <p>AC-OTF12V90 P. 323</p>	<p>O-Ring Tube Female Swivel R134a Valve</p>  <p>AC-OTF134V P. 323</p>	<p>O-Ring Tube Female 45° Elbow Swivel R134a Valve</p>  <p>AC-OTF134V45 P. 324</p>
<p>O-Ring Tube Female 90° Elbow Swivel R134a Valve</p>  <p>AC-OTF134V90 P. 324</p>	<p>O-Ring Tube Male Swivel</p>  <p>AC-OTM P. 325</p>	<p>O-Ring Tube Male 45° Elbow Swivel</p>  <p>AC-OTM45 P. 325</p>	<p>O-Ring Tube Male 90° Elbow Swivel</p>  <p>AC-OTM90 P. 326</p>
<p>O-Ring Tube Male Swivel Long Pilot</p>  <p>AC-OTMLP P. 326</p>	<p>O-Ring Tube Male Swivel R134a Valve</p>  <p>AC-OTM134V P. 327</p>	<p>O-Ring Tube Male 90° Elbow Swivel R134a Valve</p>  <p>AC-OTM134V90 P. 327</p>	<p>SAE 45° Flare Female Swivel</p>  <p>AC-SFFX P. 328</p>
<p>SAE 45° Flare Female 45° Elbow Swivel</p>  <p>AC-SFFX45 P. 328</p>	<p>SAE 45° Flare Female 90° Elbow Swivel</p>  <p>AC-SFFX90 P. 329</p>	<p>SAE 45° Flare Male</p>  <p>AC-SFM P. 329</p>	<p>SAE 45° Flare Male 45° Elbow</p>  <p>AC-SFM45 P. 330</p>
<p>SAE 45° Flare Male 90° Elbow</p>  <p>AC-SFM90 P. 330</p>			

AC Fittings Overview

GC (Cool Clip®) Fittings

Compressor Pad Block

90° Block Elbow
R12 Valve
(Switch)

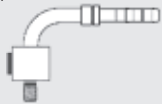

GC-CB12VS90 P. 331

Compressor Pad Block

90° Block Elbow
R12 Valve
(Switch
Reversed)

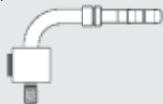

GC-CB12VSR90 P. 331

Compressor O-Ring Tube

Female
45° Elbow



GC-COTF45 P. 332

Compressor O-Ring Tube

Female
90° Elbow

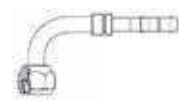

GC-COTF90 P. 332

Compressor O-Ring Tube

Female
90° Block Elbow

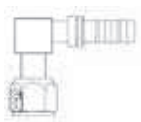

GC-COTF90B P. 332

Compressor O-Ring Tube

Female
90° Block Elbow
R134a Valve



GC-COTF134V90B P. 333

Flareless Tube

Braze-On



GC-FTBO P. 333

Flareless Tube

Male



GC-FTM P. 334

Flareless Tube

Male
90° Block Elbow



GC-FTM90B P. 334

Flareless Tube

Male
Metric



GC-FTMM P. 335

Ford Spring Lock

Female



GC-FSLF P. 335

Ford Spring Lock

Female
45° Elbow



GC-FSLF45 P. 336

Ford Spring Lock

Female
90° Elbow

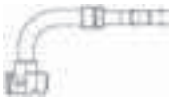

GC-FSLF90 P. 336

Ford Spring Lock

Male



GC-FSLM P. 337

Ford Spring Lock

Male
45° Elbow



GC-FSLM45 P. 337

Ford Spring Lock

Male
90° Elbow



GC-FSLM90 P. 338

Hose Mender

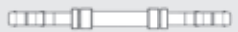

GC-HM P. 338

Hose Mender

90° Elbow



GC-HM90 P. 339

Hose Mender

180° Elbow

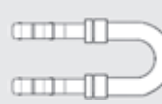

GC-HM180 P. 339

Hose Mender

R12 Valve



GC-HM12V P. 339

Hose Mender

R134a Valve



GC-HM134V P. 340

Hose Mender with Sight Glass



GC-HMSG P. 340

Hose Mender, Tee

R134a Valve



GC-HMT P. 340

O-Ring Face Seal

Female
Swivel



GC-OFFX P. 341

O-Ring Face Seal

Female
90° Elbow
Swivel



GC-OFFX90 P. 341

O-Ring Insert

Male



GC-OIM P. 341

O-Ring Insert

Male
45° Elbow



GC-OIM45 P. 342

O-Ring Insert

Male
90° Elbow



GC-OIM90 P. 342



Download the **MyCrimp App** for more information.

















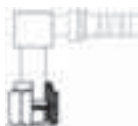







Section 8
AC Fittings

FITTINGS



AC Fittings Overview

GC (Cool Clip®) Fittings

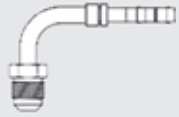
<p>O-Ring Insert Male Bulkhead</p>  <p>GC-OIMB P. 342</p>	<p>O-Ring Insert Male Bulkhead 90° Elbow</p>  <p>GC-OIMB90 P. 343</p>	<p>O-Ring Insert Male R134a Valve</p>  <p>GC-OIM134V P. 343</p>	<p>O-Ring Insert Male 90° Elbow R134a Valve</p>  <p>GC-OIM134V90 P. 343</p>
<p>O-Ring Insert Female Swivel</p>  <p>GC-OTF P. 344</p>	<p>O-Ring Tube Female 45° Elbow Swivel</p>  <p>GC-OTF45 P. 344</p>	<p>O-Ring Tube Female 90° Elbow Swivel</p>  <p>GC-OTF90 P. 345</p>	<p>O-Ring Tube Female 90° Block Elbow Swivel</p>  <p>GC-OTF90B P. 345</p>
<p>O-Ring Tube Female 180° Elbow Swivel</p>  <p>GC-OTF180 P. 346</p>	<p>O-Ring Tube Female Swivel R12 Valve</p>  <p>GC-OTF12V P. 346</p>	<p>O-Ring Tube Female 90° Elbow Swivel R12 Valve</p>  <p>GC-OTF12V90 P. 346</p>	<p>O-Ring Tube Female Swivel R134a Valve</p>  <p>GC-OTF134V P. 347</p>
<p>O-Ring Tube Female 45° Elbow Swivel R134a Valve</p>  <p>GC-OTF134V45 P. 347</p>	<p>O-Ring Tube Female 90° Elbow Swivel R134a Valve</p>  <p>GC-OTF134V90 P. 348</p>	<p>O-Ring Tube Male Swivel</p>  <p>GC-OTM P. 348</p>	<p>O-Ring Tube Male 45° Elbow Swivel</p>  <p>GC-OTM45 P. 349</p>
<p>O-Ring Tube Male 90° Elbow Swivel</p>  <p>GC-OTM90 P. 349</p>	<p>O-Ring Tube Male Swivel Long Pilot</p>  <p>GC-OTMLP P. 350</p>	<p>O-Ring Tube Male Swivel R134a Valve</p>  <p>GC-OTM134V P. 350</p>	<p>O-Ring Tube Male 90° Elbow Swivel R134a Valve</p>  <p>GC-OTM134V90 P. 350</p>
<p>SAE 45° Flare Female Swivel</p>  <p>GC-SFFX P. 351</p>	<p>SAE 45° Flare Female 45° Elbow Swivel</p>  <p>GC-SFFX45 P. 351</p>	<p>SAE 45° Flare Female 90° Elbow Swivel</p>  <p>GC-SFFX90 P. 352</p>	<p>SAE 45° Flare Male</p>  <p>GC-SFM P. 352</p>
<p>SAE 45° Flare Male 45° Elbow</p>  <p>GC-SFM45 P. 353</p>	<p>SAE 45° Flare Male 90° Elbow</p>  <p>GC-SFM90 P. 353</p>		

AC Fittings Overview

AC Adapters

O-Ring Tube Compressor

Female to O-Ring Insert
Male
90° Elbow
R134a Valve

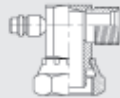

AC-OTCF P. 354

O-Ring Tube

Female to O-Ring Insert
Male
R12 Valve



AC-OTF P. 354

O-Ring Tube

Female to O-Ring Insert
Male
90° Elbow
R12 Valve



AC-OTF P. 354

O-Ring Tube

Female to O-Ring Insert
Male
R134a Valve



AC-OTF P. 355

O-Ring Tube Compressor

Female to O-Ring Insert
Male
90° Elbow
R134a Valve

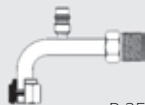

AC-OTF P. 355

AC Fittings Accessories

Flareless Tube Nuts



AC-FTN P. 356

Flareless Tube Sleeves



AC-FTS P. 356

Flareless Tube Sleeves

Metric



AC-FTSM P. 356

Inline Orifice Tubes



AC-ILOT P. 357

O-Ring - Ford Spring Lock



GC-OFSL P. 357

O-Ring - Switch



GC-OSWCH P. 357

O-Ring - Tube Fittings



AC-OTUBE P. 358

Sealing Washers



AC-SW P. 358

Valve Adapters

Female
45° Elbow



AC-VA P. 358

Valve Caps

Female
90° Elbow



AC-VC P. 359

Valve Core

Male



AC-VCORE P. 359

Metal Clip

Male
45° Elbow



GC-CLIP P. 360

Plastic Clip Holder

Male
90° Elbow



GC-CLIPHDR P. 360

Clip Pliers



GC-PLIERS P. 361

Hose Cutting Tool & Replacement Blades



HCT P. 361



Download the **MyCrimp App** for more information.

Section 8
AC Fittings

FITTINGS



AC (COOL CRIMP™) FITTINGS FOR GALAXY® G4826 AND G4867

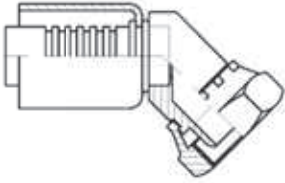

Compressor O-Ring Tube

Female / 45° Elbow



Part Number	Product Number	SAP Number	Hose ID		Drop (D)		Cut-Off (R)	
			in.	mm	in.	mm	in.	mm
AC-COTF45-0810	50133-0810	20306551	13/32	1-14	1.10	28	2.01	51
AC-COTF45-1010	50133-1010	20306545	1/2	1-14	1.26	32	1.38	35
AC-COTF45-1210	50133-1210	20306546	5/8	1-14	0.67	17	1.26	32

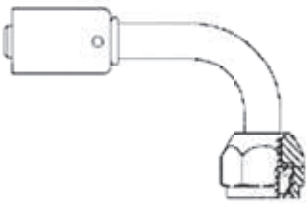

Compressor O-Ring Tube

Female / 90° Elbow



Part Number	Product Number	SAP Number	Hose ID		Drop (D)		Cut-Off (R)	
			in.	mm	in.	mm	in.	mm
AC-COTF90-0810	50135-0810	20306547	13/32	1-14	1.93	49	1.77	45
AC-COTF90-1010	50135-1010	20306548	1/2	1-14	2.20	56	1.77	45
AC-COTF90-1210	50135-1210	20306549	5/8	1-14	2.72	69	2.36	60

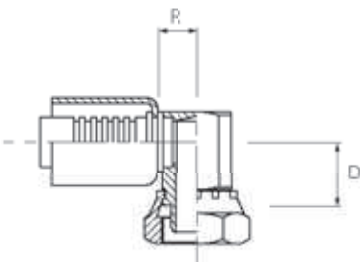

Compressor O-Ring Tube

Female / 90° Block Elbow







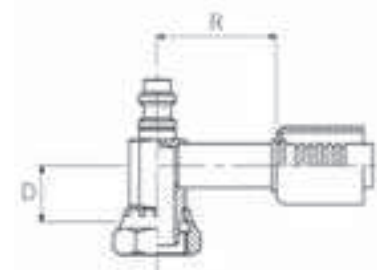

Part Number	Product Number	SAP Number	Hose ID		Drop (D)		Cut-Off (R)	
			in.	mm	in.	mm	in.	mm
AC-COTF90B-0810	50137-0810	20306610	13/32	1-14	0.83	21	0.94	24
AC-COTF90B-1010	50137-1010	20306611	1/2	1-14	0.83	21	0.94	24
AC-COTF90B-1210	50137-1210	20306612	5/8	1-14	0.83	21	1.06	27

AC (COOL CRIMP™) FITTINGS FOR GALAXY® G4826 AND G4867

Compressor O-Ring Tube

Female / 90° Block Elbow / R134a Valve





Part Number	Product Number	SAP Number								
			Hose ID	Thread Size (A)	Drop (D)	Cut-Off (R)		Valve (V)		
			in.		in.	mm	in.	mm	in.	mm
AC-COTF134V90B-0810	50145-0810	20306990	13/32	1-14	0.83	21	0.94	24	0.63	16
AC-COTF134V90B-1010	50145-1010	20306991	1/2	1-14	0.83	21	0.94	24	0.51	13
AC-COTF134V90B-1210	50145-1210	20306992	5/8	1-14	0.83	21	1.06	27	0.51	13

Flareless Tube

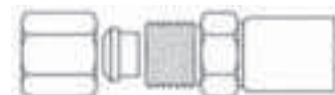
Male



Part Number	Product Number	SAP Number				
			Hose ID	Thread Size (A)	Cut-Off (R)	
			in.		in.	mm
AC-FTM-0606	50230-0606	20306613	5/16	5/8-18	1.46	37
AC-FTM-0806	50230-0806	20306615	13/32	5/8-18	1.61	41
AC-FTM-0808	50230-0808	20306616	13/32	3/4-16	1.61	41
AC-FTM-1008	50230-1008	20306618	1/2	3/4-16	2.13	54
AC-FTM-1010	50230-1010	20306619	1/2	7/8-14	2.13	54
AC-FTM-1210	50230-1210	20306620	5/8	7/8-14	2.36	60
AC-FTM-1212	50230-1212	20306621	5/8	1 1/6 -14	2.36	60



Download the **MyCrimp App** for more information.

Section 8
AC Fittings

FITTINGS



AC (COOL CRIMP™) FITTINGS FOR GALAXY® G4826 AND G4867

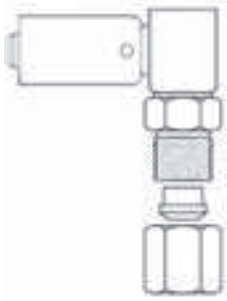

Flareless Tube

Male / 90° Block Elbow



Part Number	Product Number	SAP Number	Hose ID	Thread Size (A)	Drop (D)		Cut-Off (R)	
			in.		in.	mm	in.	mm
AC-FTM90B-0606	50235-0606	20306622	5/16	5/8-18	1.50	38	1.06	27
AC-FTM90B-0808	50235-0808	20306623	13/32	3/4-16	1.73	44	1.26	32
AC-FTM90B-0810	50235-0810	20306624	13/32	7/8-14	2.01	51	1.50	38
AC-FTM90B-1008	50235-1008	20306625	1/2	3/4-16	2.01	51	1.50	38
AC-FTM90B-1010	50235-1010	20306626	1/2	7/8-14	2.01	51	1.50	38
AC-FTM90B-1210	50235-1210	20306627	5/8	7/8-14	2.36	60	2.36	60
AC-FTM90B-1212	50235-1212	20306628	5/8	1 1/6-14	2.36	60	2.36	60

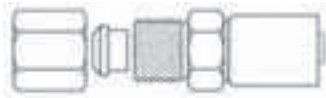

Flareless Tube

Male / Metric



Part Number	Product Number	SAP Number	Hose ID	Thread Size (A)	Cut-Off (R)	
			in.		in.	mm
AC-FTMM-0608	50240-0608	20306629	5/16	5/8-18	1.61	41
AC-FTMM-0812	50240-0812	20306630	13/32	3/4-16	2.13	54
AC-FTMM-1015	50240-1015	20306631	1/2	7/8-14	2.36	60

AC (COOL CRIMP™) FITTINGS FOR GALAXY® G4826 AND G4867

Hose Mender



Part Number	Product Number	SAP Number	Hose ID		Cut-Off (R)	
			in.	mm	in.	mm
AC-HM-0606	50350-0606	20306643	5/16	12.7	1.73	44
AC-HM-0608	50350-0608	20306644	5/16	12.7	1.73	44
AC-HM-0808	50350-0808	20306645	13/32	10.4	1.61	41
AC-HM-0810	50350-0810	20306646	13/32	10.4	1.73	44
AC-HM-1010	50350-1010	20306647	1/2	12.7	1.73	44
AC-HM-1210	50350-1210	20306648	5/8	15.9	1.73	44
AC-HM-1212	50350-1212	20306649	5/8	15.9	2.01	51

Hose Mender

90° Elbow



Part Number	Product Number	SAP Number	Hose ID		Drop (D)		Cut-Off (R)	
			in.	mm	in.	mm	in.	mm
AC-HM90-0606	50355-0606	20306650	5/16	12.7	0.98	25	0.98	25
AC-HM90-0808	50355-0808	20306651	13/32	10.4	1.73	44	1.73	44
AC-HM90-1010	50355-1010	20306652	1/2	12.7	2.24	57	2.24	57
AC-HM90-1212	50355-1212	20306653	5/8	15.9	2.64	67	2.64	67



Download the **MyCrimp App** for more information.

Section 8
AC Fittings

FITTINGS



AC (COOL CRIMP™) FITTINGS FOR GALAXY® G4826 AND G4867

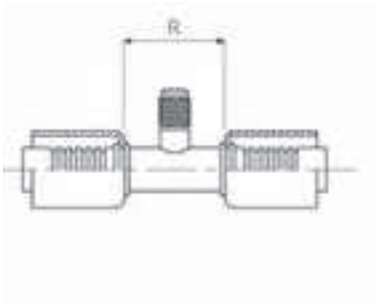

Hose Mender

R12 Valve



Part Number	Product Number	SAP Number	Hose ID			Valve (V)	
			in.	in.	mm	in.	mm
AC-HM12V-0606	50365-0606	20306658	5/16	1.61	41	1/4	6.35
AC-HM12V-0808	50365-0808	20306659	13/32	1.73	44	1/4	6.35
AC-HM12V-1010	50365-1010	20306670	1/2	1.61	41	1/4	6.35
AC-HM12V-1212	50365-1212	20306671	5/8	1.73	44	1/4	6.35

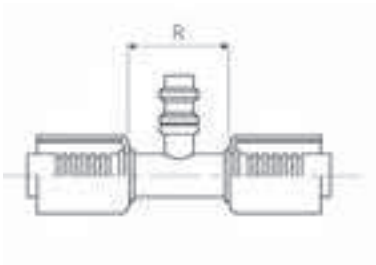

Hose Mender

R134a Valve



Part Number	Product Number	SAP Number	Hose ID			Valve (V)	
			in.	in.	mm	in.	mm
AC-HM134V-0606	50370-0606	20306672	5/16	1.73	44	0.63	16
AC-HM134V-0808	50370-0808	20306673	13/32	1.73	44	0.63	16
AC-HM134V-1010	50370-1010	20306674	1/2	1.73	44	0.51	13
AC-HM134V-1212	50370-1212	20306675	5/8	2.01	47	0.51	13

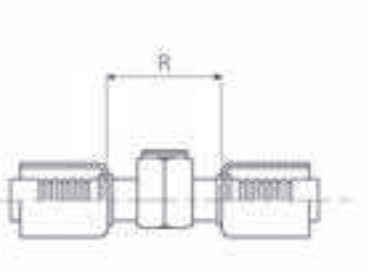

Hose Mender with Sight Glass



Part Number	Product Number	SAP Number	Hose ID		
			in.	in.	mm
AC-HMSG-0606	50375-0606	20306993	5/16	1.61	41

AC (COOL CRIMP™) FITTINGS FOR GALAXY® G4826 AND G4867

Hose Mender, Tee

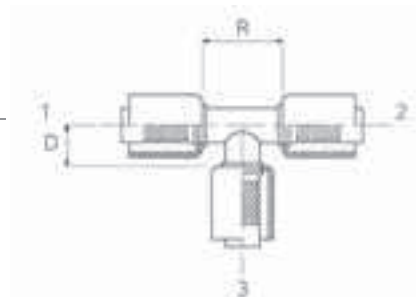

Part Number	Product Number	SAP Number	Hose ID 1 & 2	Hose ID 3	Drop (D)		Cut-Off (R)	
			in.	in.	in.	mm	in.	mm
AC-HMT-0606	50380-0606	20306676	5/16	5/16	0.98	25	1.93	49
AC-HMT-0808	50380-0808	20306677	13/32	13/32	1.26	32	2.05	52
AC-HMT-1010	50380-1010	20306678	1/2	1/2	1.26	32	2.24	57
AC-HMT-1210	50380-1210	20306994	5/8	1/2	1.38	35	2.05	52
AC-HMT-1212	50380-1212	20306679	5/8	5/8	1.26	32	2.05	52

O-Ring Insert

Male

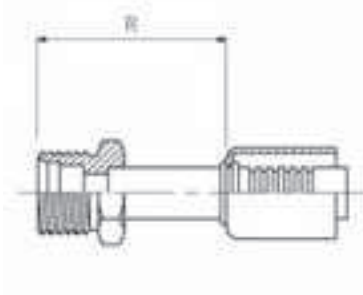

Part Number	Product Number	SAP Number	Hose ID	Thread Size (A)	Cut-Off (R)	
			in.		in.	mm
AC-OIM-0606	50500-0606	20306684	5/16	5/8-18	1.46	37
AC-OIM-0808	50500-0808	20306685	13/32	3/4-16	1.61	41
AC-OIM-1010	50500-1010	20306686	1/2	7/8-14	2.13	54
AC-OIM-1210	50500-1210	20306687	5/8	7/8-14	1.69	43
AC-OIM-1212	50500-1212	20306688	5/8	1 1/8-14	2.36	60
AC-OIM-1412	50500-1412	20307000	3/4	1 1/8-14	2.36	60



Download the **MyCrimp App** for more information.

Section 8
AC Fittings

FITTINGS



AC (COOL CRIMP™) FITTINGS FOR GALAXY® G4826 AND G4867



O-Ring Insert

Male / 45° Elbow



Part Number	Product Number	SAP Number	Hose ID	Thread Size (A)	Drop (D)		Cut-Off (R)	
			in.		in.	mm	in.	mm
AC-OIM45-0606	50503-0606	20307001	5/16	5/8-18	0.75	19	0.83	21
AC-OIM45-0808	50503-0808	20307002	13/32	3/4-16	0.98	25	0.94	24
AC-OIM45-1010	50503-1010	20307003	1/2	7/8-14	1.26	32	1.26	32
AC-OIM45-1212	50503-1212	20307004	5/8	1 1/16-14	1.38	35	1.50	38
AC-OIM45-1412	50503-1412	20307005	3/4	1 1/16-14	1.38	35	1.50	38

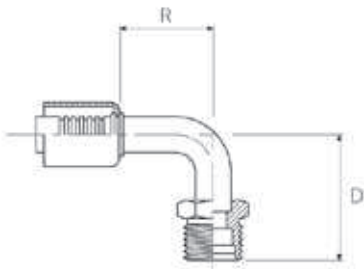

O-Ring Insert

Male / 90° Elbow



Part Number	Product Number	SAP Number	Hose ID	Thread Size (A)	Drop (D)		Cut-Off (R)	
			in.		in.	mm	in.	mm
AC-OIM90-0606	50505-0606	20306689	5/16	5/8-18	1.50	38	1.06	27
AC-OIM90-0808	50505-0808	20306690	13/32	3/4-16	1.73	44	1.26	32
AC-OIM90-1010	50505-1010	20306691	1/2	7/8-14	2.01	51	1.50	38
AC-OIM90-1210	50505-1210	20307006	5/8	7/8-14	2.17	55	1.97	50
AC-OIM90-1212	50505-1212	20307007	5/8	1 1/16-14	2.52	64	2.36	60
AC-OIM90-1412	50505-1412	20307008	3/4	1 1/16-14	2.52	64	2.36	60

AC (COOL CRIMP™) FITTINGS FOR GALAXY® G4826 AND G4867

O-Ring Insert

Male / Bulkhead

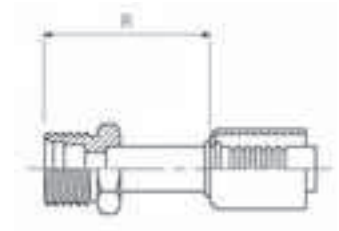

Part Number	Product Number	SAP Number	Hose ID	Thread Size (A)	Cut-Off (R)	
			in.		in.	mm
AC-OIMB-0606	50515-0606	20307009	5/16	5/8-18	2.52	64
AC-OIMB-0808	50515-0808	20307010	13/32	3/4-16	2.76	70
AC-OIMB-1010	50515-1010	20307011	1/2	7/8-14	2.95	75

O-Ring Insert

Male / Bulkhead / 90° Elbow

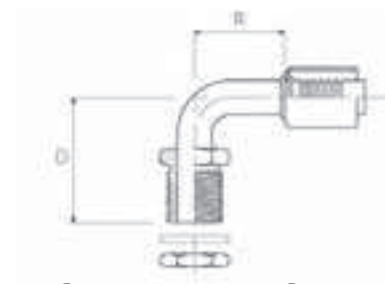

Part Number	Product Number	SAP Number	Hose ID	Thread Size (A)	Drop (D)	Cut-Off (R)		
			in.		in.	mm	in.	mm
AC-OIMB90-0606	50520-0606	20307012	5/16	5/8-18	2.13	54	1.61	41
AC-OIMB90-0808	50520-0808	20307013	13/32	3/4-16	2.44	62	1.73	44
AC-OIMB90-1010	50520-1010	20307014	5/8	7/8-14	2.52	64	2.01	51

O-Ring Insert

Male / R134a Valve



Part Number	Product Number	SAP Number	Hose ID	Thread Size (A)	Cut-Off (R)		Valve (V)	
			in.		in.	mm	in.	mm
AC-OIM134V-0606	50530-0606	20307015	5/16	5/8-18	2.44	62	0.63	16
AC-OIM134V-0808	50530-0808	20307016	13/32	3/4-16	2.56	65	0.63	16
AC-OIM134V-1010	50530-1010	20307017	1/2	7/8-14	1.77	45	0.51	13
AC-OIM134V-1212	50530-1212	20307018	5/8	1 1/8-14	2.95	75	0.51	13



Download the **MyCrimp App** for more information.

Section 8
AC Fittings

FITTINGS



AC (COOL CRIMP™) FITTINGS FOR GALAXY® G4826 AND G4867

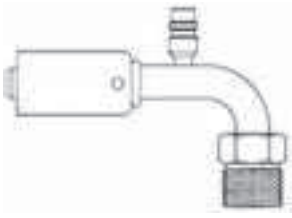

O-Ring Insert

Male / 90° Elbow / R134a Valve



Part Number	Product Number	SAP Number	Hose ID	Thread Size (A)	Drop (D)		Cut-Off (R)		Valve (V)	
			in.		in.	mm	in.	mm	in.	mm
AC-OIM134V90-0606	50535-0606	20307019	5/16	5/8-18	1.61	41	2.13	54	0.63	16
AC-OIM134V90-0808	50535-0808	20307020	13/32	3/4-16	1.89	48	2.13	54	0.63	16
AC-OIM134V90-1010	50535-1010	20307021	1/2	7/8-14	2.13	54	2.36	60	0.51	13

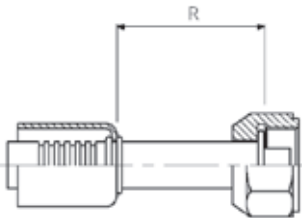

O-Ring Tube

Female / Swivel







Part Number	Product Number	SAP Number	Hose ID	Thread Size (A)	Cut-Off (R)	
			in.		in.	mm
AC-OTF-0605	50600-0605	20307022	5/16	9/16-18	1.30	33
AC-OTF-0606	50600-0606	20306692	5/16	5/8-18	1.38	35
AC-OTF-0608	50600-0608	20306693	5/16	3/4-16	1.50	38
AC-OTF-0806	50600-0806	20307023	13/32	5/8-18	1.50	38
AC-OTF-0808	50600-0808	20306694	13/32	3/4-16	1.50	38
AC-OTF-1008	50600-1008	20307024	1/2	3/4-16	1.69	43
AC-OTF-1010	50600-1010	20306695	1/2	7/8-14	1.69	43
AC-OTF-1012	50600-1012	20307025	1/2	1 1/6 -14	1.81	46
AC-OTF-1210	50600-1210	20306696	5/8	7/8-14	1.81	46
AC-OTF-1212	50600-1212	20306697	5/8	1 1/6 -14	1.81	46
AC-OTF-1412	50600-1412	20307026	3/4	1 1/6 -14	1.81	46

AC (COOL CRIMP™) FITTINGS FOR GALAXY® G4826 AND G4867

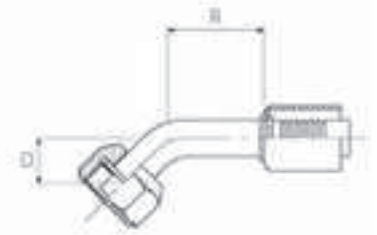
O-Ring Tube

Female / 45° Elbow / Swivel





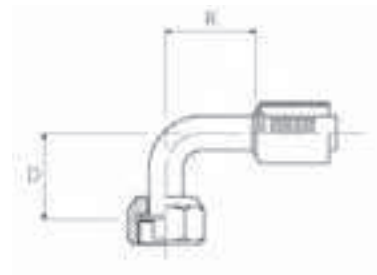

Part Number	Product Number	SAP Number						
			Hose ID	Thread Size (A)	Drop (D)		Cut-Off (R)	
			in.		in.	mm	in.	mm
AC-OTF45-0606	50603-0606	20306698	5/16	5/8-18	0.55	14	0.83	21
AC-OTF45-0806	50603-0806	20307027	13/32	5/8-18	0.63	16	0.94	24
AC-OTF45-0808	50603-0808	20306699	13/32	3/4-16	0.63	16	0.94	24
AC-OTF45-1010	50603-1010	20306700	1/2	7/8-14	0.87	22	1.26	32
AC-OTF45-1210	50603-1210	20306701	5/8	7/8-14	0.94	24	1.50	38
AC-OTF45-1212	50603-1212	20306702	5/8	1 1/6-14	0.94	24	1.50	38
AC-OTF45-1412	50603-1412	20307028	3/4	1 1/6-14	0.94	24	1.50	38

O-Ring Tube

Female / 90° Elbow / Swivel



Part Number	Product Number	SAP Number						
			Hose ID	Thread Size (A)	Drop (D)		Cut-Off (R)	
			in.		in.	mm	in.	mm
AC-OTF90-0605	50605-0605	20307029	5/16	9/16-18	1.10	28	1.26	32
AC-OTF90-0606	50605-0606	20306703	5/16	5/8-18	1.10	28	1.06	27
AC-OTF90-0608	50605-0608	20306704	5/16	3/4-16	1.30	33	1.26	32
AC-OTF90-0806	50605-0806	20307030	13/32	5/8-18	1.30	33	1.26	32
AC-OTF90-0808	50605-0808	20306705	13/32	3/4-16	1.30	33	1.26	32
AC-OTF90-1008	50605-1008	20307031	1/2	3/4-16	1.50	38	1.50	38
AC-OTF90-1010	50605-1010	20306706	1/2	7/8-14	1.50	38	1.50	38
AC-OTF90-1210	50605-1210	20306707	5/8	7/8-14	1.77	45	1.77	45
AC-OTF90-1212	50605-1212	20306708	5/8	1 1/6-14	1.77	45	1.77	45
AC-OTF90-1412	50605-1412	20307033	3/4	1 1/6-14	1.77	45	1.77	45



Download the **MyCrimp App** for more information.

Section 8
AC Fittings

FITTINGS



AC (COOL CRIMP™) FITTINGS FOR GALAXY® G4826 AND G4867

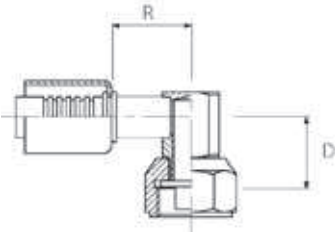

O-Ring Tube

Female / 90° Block Elbow / Swivel



Part Number	Product Number	SAP Number	Hose ID	Thread Size (A)	Drop (D)		Cut-Off (R)	
			in.		in.	mm	in.	mm
AC-OTF90B-0808	50610-0808	20306709	13/32	3/4-16	0.75	19	0.94	24
AC-OTF90B-1010	50610-1010	20306710	1/2	7/8-14	0.75	19	0.98	25
AC-OTF90B-1210	50610-1210	20306711	5/8	7/8-14	0.75	19	0.98	25

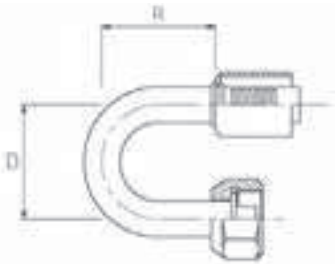

O-Ring Tube

Female / 180° Elbow / Swivel







Part Number	Product Number	SAP Number	Hose ID	Thread Size (A)	Drop (D)		Cut-Off (R)	
			in.		in.	mm	in.	mm
AC-OTF180-0606	50615-0606	20307034	5/16	5/8-18	1.61	41	2.01	51
AC-OTF180-0808	50615-0808	20307035	13/32	3/4-16	1.73	44	2.01	51
AC-OTF180-1212	50615-1212	20307036	5/8	1 1/6-14	2.13	54	2.99	76

AC (COOL CRIMP™) FITTINGS FOR GALAXY® G4826 AND G4867

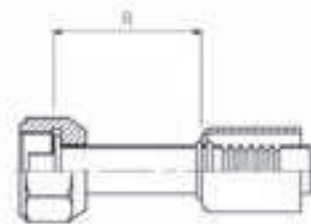
O-Ring Tube

Female / Swivel / Metric





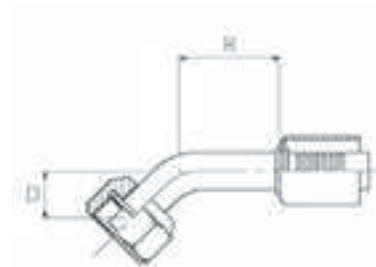

Part Number	Product Number	SAP Number				
			Hose ID	Thread Size (A)	Cut-Off (R)	
			in.		in.	mm
AC-OTFM-0616	50630-0616	20306712	5/16	16x1.5	1.54	39
AC-OTFM-0618	50630-0618	20307037	5/16	18x1.5	1.54	39
AC-OTFM-0620	50630-0620	20307038	5/16	20x1.5	1.54	39
AC-OTFM-0820	50630-0820	20307039	13/32	20x1.5	1.69	43
AC-OTFM-1024	50630-1024	20306714	1/2	24x2.0	1.69	43
AC-OTFM-1227	50630-1227	20306715	5/8	27x2.0	1.81	46

O-Ring Tube

Female / 45° Elbow / Swivel / Metric



Part Number	Product Number	SAP Number						
			Hose ID	Thread Size (A)	Drop (D)		Cut-Off (R)	
			in.		in.	mm	in.	mm
AC-OTFM45-0614	50633-0614	20307040	5/16	14x1.5	0.55	14	0.98	25
AC-OTFM45-0616	50633-0616	20307041	5/16	16x1.5	0.55	14	0.98	25
AC-OTFM45-0618	50633-0618	20307042	5/16	18x1.5	0.55	14	0.98	25
AC-OTFM45-0620	50633-0620	20307043	5/16	20x1.5	0.55	14	0.98	25
AC-OTFM45-0820	50633-0820	20307044	13/32	20x1.5	0.63	16	0.98	25
AC-OTFM45-1022	50633-1022	20307045	1/2	22x1.5	0.87	22	1.26	32
AC-OTFM45-1024	50633-1024	20307046	1/2	24x2.0	0.87	22	1.26	32
AC-OTFM45-1227	50633-1227	20307047	5/8	27x2.0	0.94	24	1.50	38



Download the **MyCrimp App** for more information.

Section 8
AC Fittings

FITTINGS





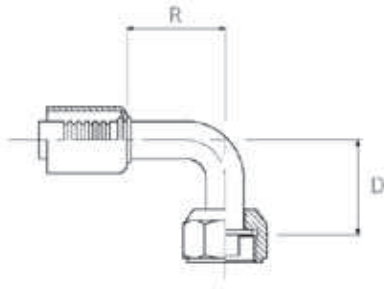

AC (COOL CRIMP™) FITTINGS FOR GALAXY® G4826 AND G4867



O-Ring Tube



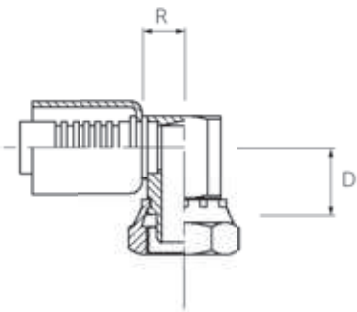

Female / 90° Elbow / Swivel / Metric

Part Number	Product Number	SAP Number						
			Hose ID	Thread Size (A)	Drop (D)		Cut-Off (R)	
			in.		in.	mm	in.	mm
AC-OTFM90-0616	50635-0616	20306716	5/16	16x1.5	1.10	28	1.06	27
AC-OTFM90-0618	50635-0618	20307048	5/16	18x1.5	1.10	28	1.06	27
AC-OTFM90-1022	50635-1022	20306717	1/2	22x1.5	1.50	38	1.50	38
AC-OTFM90-1227	50635-1227	20306719	5/8	27x2.0	1.77	45	1.77	45



O-Ring Tube

Female / Swivel / R12 Valve





Part Number	Product Number	SAP Number						
			Hose ID	Thread Size (A)	Cut-Off (R)		Valve (V)	
			in.		in.	mm	in.	mm
AC-OTF12V-0606	50650-0606	20307051	5/16	5/8-18	1.89	48	1/4	6.35
AC-OTF12V-0808	50650-0808	20307052	13/32	3/4-16	1.89	48	1/4	6.35
AC-OTF12V-1010	50650-1010	20307053	1/2	7/8-14	2.13	54	1/4	6.35

AC (COOL CRIMP™) FITTINGS FOR GALAXY® G4826 AND G4867

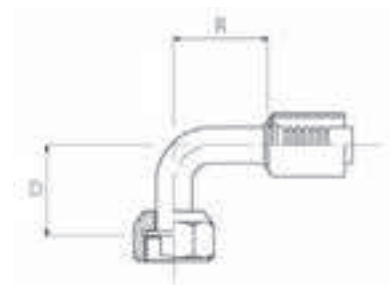
O-Ring Tube

Female / 90° Elbow / Swivel / R12 Valve





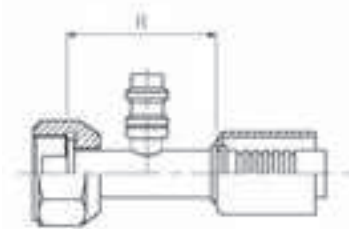

Part Number	Product Number	SAP Number								
			Hose ID	Thread Size (A)	Drop (D)		Cut-Off (R)		Valve (V)	
			in.		in.	mm	in.	mm	in.	mm
AC-OTF12V90-0606	50655-0606	20306720	5/16	5/8-18	1.10	28	2.13	54	1/4	6.35
AC-OTF12V90-0808	50655-0808	20306721	13/32	3/4-16	1.30	33	2.13	54	1/4	6.35
AC-OTF12V90-1010	50655-1010	20306722	1/2	7/8-14	1.50	38	2.36	60	1/4	6.35
AC-OTF12V90-1210	50655-1210	20306723	5/8	7/8-14	1.73	44	2.68	68	1/4	6.35

O-Ring Tube

Female / Swivel / R134a Valve



Part Number	Product Number	SAP Number						
			Hose ID	Thread Size (A)	Cut-Off (R)		Valve (V)	
			in.		in.	mm	in.	mm
AC-OTF134V-0606	50660-0606	20306724	5/16	5/8-18	1.89	48	0.63	16
AC-OTF134V-0808	50660-0808	20306725	13/32	3/4-16	1.89	48	0.63	16
AC-OTF134V-1010	50660-1010	20306726	1/2	7/8-14	2.13	54	0.51	13
AC-OTF134V-1210	50660-1210	20306727	5/8	7/8-14	2.24	57	0.51	13
AC-OTF134V-1212	50660-1212	20307054	5/8	1 1/16-14	2.24	57	0.51	13
AC-OTF134V-1412	50660-1412	20307055	3/4	1 1/16-14	2.24	57	0.51	13
AC-OTF134VHS-1010	50675-1010	20307063	1/2	7/8-14	2.13	54	0.63	16



Download the **MyCrimp App** for more information.

Section 8
AC Fittings

FITTINGS





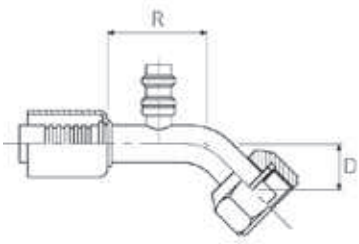

AC (COOL CRIMP™) FITTINGS FOR GALAXY® G4826 AND G4867



O-Ring Tube



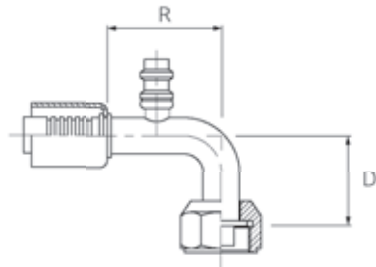

Female / 45° Elbow / Swivel / R134a Valve

Part Number	Product Number	SAP Number								
			Hose ID	Thread Size (A)	Drop (D)	Cut-Off (R)	in.	mm		
AC-OTF134V45-0606	50663-0606	20307056	5/16	5/8-18	0.55	14	1.61	41	0.63	16
AC-OTF134V45-0808	50663-0808	20306728	13/32	3/4-16	0.63	16	1.61	41	0.63	16
AC-OTF134V45-1010	50663-1010	20307057	1/2	7/8-14	0.87	22	1.73	44	0.51	13
AC-OTF134V45-1210	50663-1210	20306729	5/8	7/8-14	0.94	24	1.89	48	0.51	13
AC-OTF134V45-1212	50663-1212	20307058	5/8	1 1/6-14	0.94	24	1.89	48	0.51	13
AC-OTF134V45-1412	50663-1412	20307059	3/4	1 1/6-14	0.94	24	1.89	48	0.51	13



O-Ring Tube

Female / 90° Elbow / Swivel / R134a Valve



Part Number	Product Number	SAP Number								
			Hose ID	Thread Size (A)	Drop (D)	Cut-Off (R)	in.	mm		
AC-OTF134V90-0606	50665-0606	20306730	5/16	5/8-18	1.10	28	2.13	54	0.63	16
AC-OTF134V90-0806	50665-0806	20307060	13/32	5/8-18	1.30	33	2.13	54	0.63	16
AC-OTF134V90-0808	50665-0808	20306731	13/32	3/4-16	1.30	33	2.13	54	0.63	16
AC-OTF134V90-1010	50665-1010	20306732	1/2	7/8-14	1.50	38	2.36	60	0.51	13
AC-OTF134V90-1210	50665-1210	20306733	5/8	7/8-14	1.73	44	2.68	68	0.51	13
AC-OTF134V90-1212	50665-1212	20307061	5/8	1 1/6-14	1.73	44	2.68	68	0.51	13
AC-OTF134V90-1412	50665-1412	20307062	3/4	1 1/6-14	1.73	44	2.68	68	0.51	13

AC (COOL CRIMP™) FITTINGS FOR GALAXY® G4826 AND G4867

O-Ring Tube

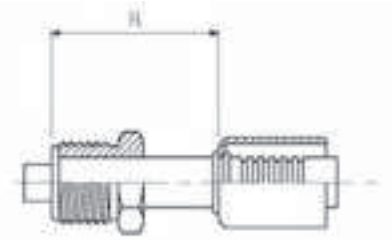
Male / Swivel





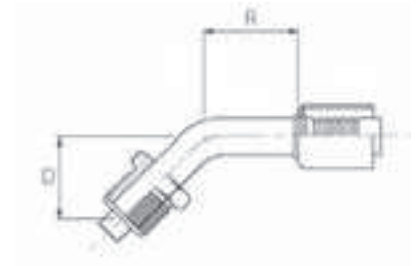

Part Number	Product Number	SAP Number				
			Hose ID	Thread Size (A)	in.	mm
AC-OTM-0606	50700-0606	20306734	5/16	5/8-18	1.69	43
AC-OTM-0608	50700-0608	20306736	5/16	3/4-18	1.77	45
AC-OTM-0808	50700-0808	20306737	13/32	3/4-18	1.77	45
AC-OTM-1010	50700-1010	20306738	1/2	7/8-18	1.89	48
AC-OTM-1012	50700-1012	20306739	1/2	1 1/6-16	2.36	60
AC-OTM-1210	50700-1210	20306740	5/8	7/8-18	2.36	60
AC-OTM-1212	50700-1212	20306741	5/8	1 1/6-16	2.36	60

O-Ring Tube

Male / 45° Elbow / Swivel



Part Number	Product Number	SAP Number						
			Hose ID	Thread Size (A)	in.	mm	in.	mm
AC-OTM45-0606	50703-0606	20306742	5/16	5/8-18	0.87	22	0.83	21
AC-OTM45-0808	50703-0808	20306743	13/32	3/4-18	0.98	25	0.94	24
AC-OTM45-1010	50703-1010	20306744	1/2	7/8-18	1.06	27	1.26	32
AC-OTM45-1210	50703-1210	20306745	5/8	7/8-18	1.18	30	1.50	38
AC-OTM45-1212	50703-1212	20306746	5/8	1 1/6-16	1.18	30	1.50	38



Download the **MyCrimp App**
for more information.

Section 8
AC Fittings

FITTINGS



AC (COOL CRIMP™) FITTINGS FOR GALAXY® G4826 AND G4867

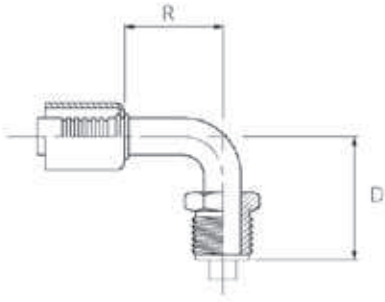

O-Ring Tube

Male / 90° Elbow / Swivel

Part Number	Product Number	SAP Number			Drop (D)		Cut-Off (R)	
			Hose ID	Thread Size (A)	in.	mm	in.	mm
AC-OTM90-0606	50705-0606	20306747	5/16	5/8-18	1.61	41	1.06	27
AC-OTM90-0608	50705-0608	20306748	5/16	3/4-18	1.89	48	1.26	32
AC-OTM90-0806	50705-0806	20306749	13/32	5/8-18	1.89	48	1.26	32
AC-OTM90-0808	50705-0808	20306750	13/32	3/4-18	1.89	48	1.26	32
AC-OTM90-1010	50705-1010	20306751	1/2	7/8-18	2.13	54	1.50	38
AC-OTM90-1012	50705-1012	20306752	1/2	1 1/6-16	2.24	57	1.77	45
AC-OTM90-1210	50705-1210	20306753	5/8	7/8-18	2.24	57	1.77	45
AC-OTM90-1212	50705-1212	20306754	5/8	1 1/6-16	2.24	57	1.77	45

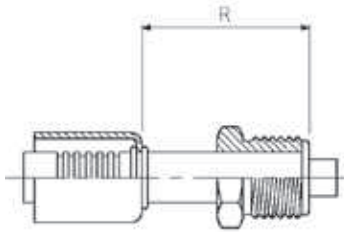

O-Ring Tube

Male / Swivel / Long Pilot





Part Number	Product Number	SAP Number			Cut-Off (R)	
			Hose ID	Thread Size (A)	in.	mm
AC-OTMLP-0606	50720-0606	20307064	5/16	5/8-18	1.06	27
AC-OTMLP-0808	50720-0808	20307065	13/32	3/4-18	1.26	32
AC-OTMLP-1010	50720-1010	20307066	1/2	7/8-18	1.50	38
AC-OTMLP-1210	50720-1210	20307067	5/8	7/8-18	1.77	45

AC (COOL CRIMP™) FITTINGS FOR GALAXY® G4826 AND G4867

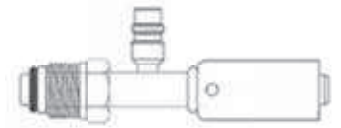
O-Ring Tube

Male / Swivel / R134a Valve





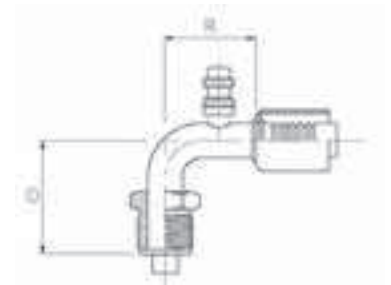

Part Number	Product Number	SAP Number						
			Hose ID	Thread Size (A)	Cut-Off (R)		Valve (V)	
			in.		in.	mm	in.	mm
AC-OTM134V-0606	50730-0606	20307068	5/16	5/8-18	1.69	43	0.63	16
AC-OTM134V-0808	50730-0808	20307069	13/32	3/4-18	1.77	45	0.63	16
AC-OTM134V-1010	50730-1010	20307070	1/2	7/8-18	2.36	60	0.51	13
AC-OTM134V-1210	50730-1210	20306755	5/8	7/8-18	2.36	60	0.51	13
AC-OTM134V-1212	50730-1212	20307071	5/8	1 1/6-16	2.52	64	0.51	13

O-Ring Tube

Male / 90° Elbow / Swivel / R134a Valve



Part Number	Product Number	SAP Number								
			Hose ID	Thread Size (A)	Drop (D)		Cut-Off (R)		Valve (V)	
			in.		in.	mm	in.	mm	in.	mm
AC-OTM134V90-1010	50735-1010	20307072	1/2	7/8-18	2.13	54	2.36	60	0.51	13
AC-OTM134V90-1210	50735-1210	20306756	5/8	7/8-18	2.13	54	2.36	60	0.51	13



Download the **MyCrimp App** for more information.

Section 8
AC Fittings

FITTINGS



AC (COOL CRIMP™) FITTINGS FOR GALAXY® G4826 AND G4867

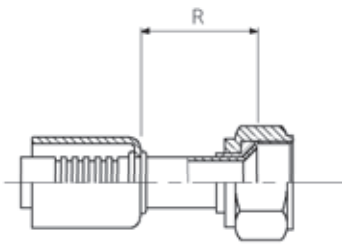

SAE 45° Flare

Female / Swivel



Part Number	Product Number	SAP Number	Hose ID	Thread Size (A)	Cut-Off (R)	
			in.		in.	mm
AC-SFFX-0606	50760-0606	20306757	5/16	5/8-18	1.38	35
AC-SFFX-0806	50760-0806	20307073	13/32	5/8-18	1.18	30
AC-SFFX-0808	50760-0808	20306759	13/32	3/4-16	1.18	30
AC-SFFX-1008	50760-1008	20307074	1/2	3/4-16	1.50	38
AC-SFFX-1010	50760-1010	20306760	1/2	7/8-14	1.50	38
AC-SFFX-1210	50760-1210	20306761	5/8	7/8-14	1.73	44
AC-SFFX-1212	50760-1212	20306762	5/8	1 1/6-14	1.73	44

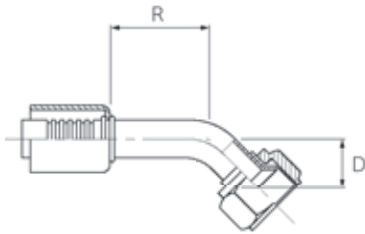

SAE 45° Flare

Female / 45° Elbow / Swivel



Part Number	Product Number	SAP Number	Hose ID	Thread Size (A)	Drop (D)		Cut-Off (R)	
			in.		in.	mm	in.	mm
AC-SFFX45-0606	50763-0606	20306763	5/16	5/8-18	0.55	14	0.83	21
AC-SFFX45-0608	50763-0608	20306764	5/16	3/4-16	0.63	16	0.94	24
AC-SFFX45-0806	50763-0806	20307075	13/32	5/8-18	0.63	16	0.94	24
AC-SFFX45-0808	50763-0808	20306765	13/32	3/4-16	0.63	16	0.94	24
AC-SFFX45-1008	50763-1008	20307076	1/2	3/4-16	0.87	22	1.26	32
AC-SFFX45-1010	50763-1010	20306766	1/2	7/8-14	0.87	22	1.26	32
AC-SFFX45-1210	50763-1210	20306767	5/8	7/8-14	0.98	25	1.50	38
AC-SFFX45-1212	50763-1212	20306768	5/8	1 1/6-14	0.98	25	1.50	38

FITTINGS



Section 8

AC Fittings

COMPATIBLE HOSE:

G4826 G4867





For a detailed list, please refer to your Crimp Specifications Manual.

AC (COOL CRIMP™) FITTINGS FOR GALAXY® G4826 AND G4867

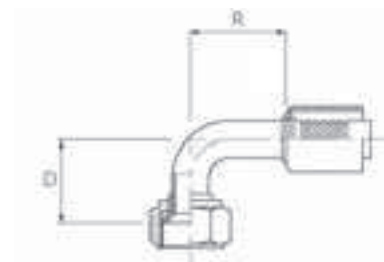
SAE 45° Flare

Female / 90° Elbow / Swivel





Part Number	Product Number	SAP Number						
			Hose ID	Thread Size (A)	Drop (D)	in.	mm	
AC-SFFX90-0606	50765-0606	20306769	5/16	5/8-18	1.06	27	1.06	27
AC-SFFX90-0608	50765-0608	20306770	5/16	3/4-16	1.26	32	1.26	32
AC-SFFX90-0806	50765-0806	20307077	13/32	5/8-18	1.26	32	1.26	32
AC-SFFX90-0808	50765-0808	20306771	13/32	3/4-16	1.26	32	1.26	32
AC-SFFX90-1008	50765-1008	20307078	1/2	3/4-16	1.50	38	1.50	38
AC-SFFX90-1010	50765-1010	20306772	1/2	7/8-14	1.50	38	1.50	38
AC-SFFX90-1210	50765-1210	20306773	5/8	7/8-14	1.50	38	1.73	44
AC-SFFX90-1212	50765-1212	20306774	5/8	1 1/8-14	1.50	38	1.73	44

SAE 45° Flare

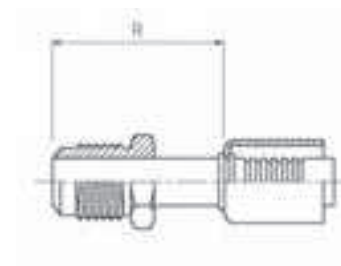
Male



Part Number	Product Number	SAP Number				
			Hose ID	Thread Size (A)	in.	mm
AC-SFM-0606A	50780-0606	20306775	5/16	5/8-18	1.89	48
AC-SFM-0808A	50780-0808	20306776	13/32	3/4-16	2.01	51
AC-SFM-1010A	50780-1010	20306777	1/2	7/8-14	2.32	59
AC-SFM-1212A	50780-1212	20306778	5/8	1 1/8-14	2.52	64



Download the **MyCrimp App** for more information.

Section 8
AC Fittings

FITTINGS



AC (COOL CRIMP™) FITTINGS FOR GALAXY® G4826 AND G4867

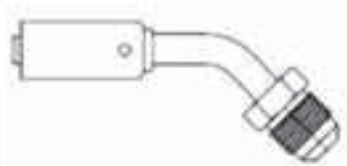

SAE 45° Flare

Male / 45° Elbow



Part Number	Product Number	SAP Number	Hose ID	Thread Size (A)	Drop (D)		Cut-Off (R)	
			in.		in.	mm	in.	mm
AC-SFM45-0606A	50783-0606	20306779	5/16	5/8-18	1.50	38	1.06	27
AC-SFM45-0808A	50783-0808	20306780	13/32	3/4-16	1.73	44	1.26	32
AC-SFM45-1010A	50783-1010	20306781	1/2	7/8-14	2.01	51	1.50	38
AC-SFM45-1212A	50783-1212	20306782	5/8	1 1/6 -14	2.52	64	2.36	60



SAE 45° Flare

Male / 90° Elbow



Part Number	Product Number	SAP Number	Hose ID	Thread Size (A)	Drop (D)		Cut-Off (R)	
			in.		in.	mm	in.	mm
AC-SFM90-0606A	50785-0606	20306783	5/16	5/8-18	0.75	19	0.83	21
AC-SFM90-1010A	50785-1010	20306785	1/2	7/8-14	1.26	32	1.26	32
AC-SFM90-1212A	50785-1212	20306786	5/8	1 1/6 -14	1.38	35	1.50	38

GC (COOL CLIP®) FITTINGS FOR GALAXY® G4890

Compressor Pad Block

90° Block Elbow / R12 Valve (Switch)

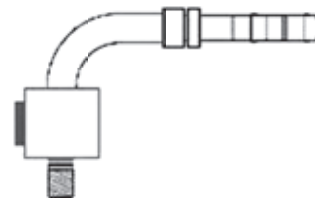

Part Number	Product Number	SAP Number	Hose ID			Drop (D)		Cut-Off (R)		Valve (V)	
			in.	in.	mm	in.	mm	in.	mm		
GC-CB12VS90-0808	54110-0808	20307089	13/32	2.63	66.8	3.00	76.2	1/4	6.35		
GC-CB12VS90-1008	54110-1008	20307090	1/2	2.63	66.8	3.00	76.2	1/4	6.35		
GC-CB12VS90-1208	54110-1208	20307091	5/8	2.63	66.8	3.00	76.2	1/4	6.35		

Compressor Pad Block

90° Elbow / R12 Valve (Switch Reversed)

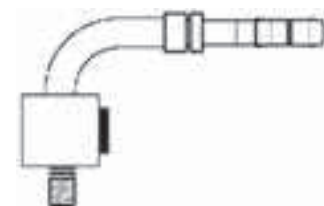

Part Number	Product Number	SAP Number	Hose ID			Drop (D)		Cut-Off (R)		Valve (V)	
			in.	in.	mm	in.	mm	in.	mm		
GC-CB12VSR90-0808	54112-0808	20307092	13/32	2.63	66.8	1.88	47.6	1/4	6.35		
GC-CB12VSR90-1008	54112-1008	20307093	1/2	2.63	66.8	1.88	47.6	1/4	6.35		
GC-CB12VSR90-1208	54112-1208	20307094	5/8	2.63	66.8	1.88	47.6	1/4	6.35		







Download the **MyCrimp App** for more information.

GC (COOL CLIP®) FITTINGS FOR GALAXY® G4890



Compressor O-Ring Tube



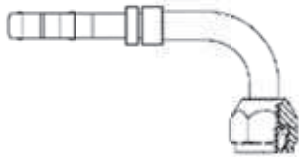

Female / 45° Elbow

Part Number	Product Number	SAP Number						
			Hose ID	Thread Size (A)	Drop (D)		Cut-Off (R)	
			in.		in.	mm	in.	mm
GC-COTF45-0810	54133-0810	20306806	13/32	1-14	0.39	10	2.01	51
GC-COTF45-1010	54133-1010	20306807	1/2	1-14	0.39	10	2.01	51
GC-COTF45-1210	54133-1210	20306808	5/8	1-14	0.39	10	2.01	51



Compressor O-Ring Tube



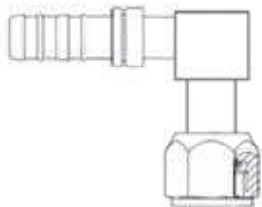

Female / 90° Elbow

Part Number	Product Number	SAP Number						
			Hose ID	Thread Size (A)	Drop (D)		Cut-Off (R)	
			in.		in.	mm	in.	mm
GC-COTF90-0810	54135-0810	20306809	13/32	1-14	0.91	23	2.13	54
GC-COTF90-1010	54135-1010	20306810	1/2	1-14	0.91	23	2.13	54
GC-COTF90-1210	54135-1210	20306811	5/8	1-14	0.91	23	2.13	54



Compressor O-Ring Tube

Female / 90° Block Elbow





Part Number	Product Number	SAP Number						
			Hose ID	Thread Size (A)	Drop (D)		Cut-Off (R)	
			in.		in.	mm	in.	mm
GC-COTF90B-0810	54137-0810	20306812	13/32	1-14	0.91	23	2.32	59
GC-COTF90B-1010	54137-1010	20306813	1/2	1-14	0.91	23	2.32	59
GC-COTF90B-1210	54137-1210	20306814	5/8	1-14	0.91	23	2.32	59

GC (COOL CLIP®) FITTINGS FOR GALAXY® G4890

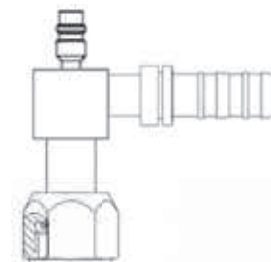
Compressor O-Ring Tube

Female / 90° Block Elbow / R134a Valve





Part Number	Product Number	SAP Number								
			Hose ID	Thread Size (A)	Drop (D)	Drop (D)	Cut-Off (R)	Cut-Off (R)	Valve (V)	Valve (V)
			in.		in.	mm	in.	mm	in.	mm
GC-COTF134V90B-0810	54145-0810	20307095	13/32	1-14	0.91	23	2.32	59	0.63	16
GC-COTF134V90B-1010	54145-1010	20307096	1/2	1-14	0.91	23	2.32	59	0.51	13
GC-COTF134V90B-1210	54145-1210	20307097	5/8	1-14	0.91	23	2.32	59	0.51	13

Flareless Tube

Braze-On



Part Number	Product Number	SAP Number		Fitting Size		
			Hose ID		Cut-Off (R)	Cut-Off (R)
			in.		in.	mm
GC-FTBO-0606	54210-0606	20306815	5/16	3/8" Fitting	1.81	46
GC-FTBO-0808	54210-0808	20306816	13/32	1/2" Fitting	1.81	46
GC-FTBO-1010	54210-1010	20306817	1/2	5/8" Fitting	1.81	46
GC-FTBO-1210	54210-1210	20306818	5/8	5/8" Fitting	1.81	46
GC-FTBO-1212	54210-1212	20306819	5/8	3/4" Fitting	1.81	46



Download the **MyCrimp App** for more information.

Section 8
GC Fittings

FITTINGS



GC (COOL CLIP®) FITTINGS FOR GALAXY® G4890

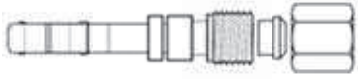

Flareless Tube

Male



Part Number	Product Number	SAP Number	Hose ID		Thread Size (A)		Cut-Off (R)	
			in.	mm	in.	mm	in.	mm
GC-FTM-0606	54230-0606	20306820	5/16		5/8-18		2.80	71
GC-FTM-0608	54230-0608	20306821	5/16		3/4-16		2.80	71
GC-FTM-0806	54230-0806	20306822	13/32		5/8-18		2.80	71
GC-FTM-0808	54230-0808	20306823	13/32		3/4-16		2.91	74
GC-FTM-0810	54230-0810	20306824	13/32		7/8-14		2.91	74
GC-FTM-1008	54230-1008	20306825	1/2		3/4-16		3.15	80
GC-FTM-1010	54230-1010	20306826	1/2		7/8-14		3.15	80
GC-FTM-1210	54230-1210	20306827	5/8		7/8-14		3.66	93
GC-FTM-1212	54230-1212	20306828	5/8		1 1/6-14		3.66	93

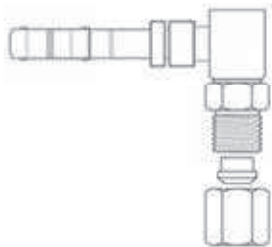

Flareless Tube

Male / 90° Block Elbow



Part Number	Product Number	SAP Number	Hose ID		Thread Size (A)		Drop (D)		Cut-Off (R)	
			in.	mm	in.	mm	in.	mm	in.	mm
GC-FTM90B-0606	54235-0606	20306829	5/16		5/8-18		1.22	31	1.42	36
GC-FTM90B-0608	54235-0608	20307098	5/16		3/4-16		1.22	31	1.42	36
GC-FTM90B-0806	54235-0806	20307099	13/32		5/8-18		1.22	31	1.42	36
GC-FTM90B-0808	54235-0808	20306830	13/32		3/4-16		1.73	44	1.61	41
GC-FTM90B-0810	54235-0810	20306831	13/32		7/8-14		1.73	44	1.61	41
GC-FTM90B-1008	54235-1008	20306832	1/2		3/4-16		1.73	44	1.61	41
GC-FTM90B-1010	54235-1010	20306833	1/2		7/8-14		2.09	53	1.93	49
GC-FTM90B-1210	54235-1210	20306834	5/8		7/8-14		2.52	64	2.64	67
GC-FTM90B-1212	54235-1212	20306835	5/8		1 1/6-14		2.52	64	2.64	67

GC (COOL CLIP®) FITTINGS FOR GALAXY® G4890

Flareless Tube

Male / Metric

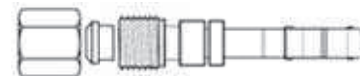

Part Number	Product Number	SAP Number	Hose ID	Thread Size (A)	Cut-Off (R)	
			in.		in.	mm
GC-FTMM-0608	54240-0608	20306836	5/16	5/8-18	2.80	71
GC-FTMM-0812	54240-0812	20306837	13/32	3/4-16	2.91	74
GC-FTMM-1015	54240-1015	20306838	1/2	7/8-14	3.66	93

Ford Spring Lock

Female

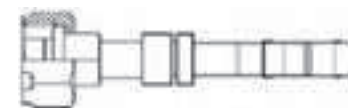

Part Number	Product Number	SAP Number	Hose ID	Thread Size (A)	Cut-Off (R)	
			in.		in.	mm
GC-FSLF-0606A	54300-0606A	20306839	5/16	FSL-06	2.87	73
GC-FSLF-0608A	54300-0608A	20306840	5/16	FSL-08	2.87	73
GC-FSLF-1010A	54300-1010A	20306842	1/2	FSL-10	3.31	84
GC-FSLF-1210A	54300-1210A	20306843	5/8	FSL-10	3.31	84
GC-FSLF-1212A	54300-1212A	20306844	5/8	FSL-12	3.31	84



Download the **MyCrimp App** for more information.

Section 8
GC Fittings

FITTINGS







GC (COOL CLIP®) FITTINGS FOR GALAXY® G4890



Ford Spring Lock



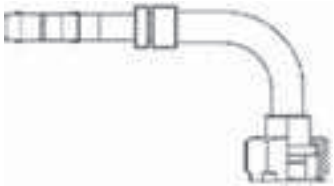

Female / 45° Elbow

Part Number	Product Number	SAP Number						
			Hose ID	Thread Size (A)	Drop (D)		Cut-Off (R)	
			in.		in.	mm	in.	mm
GC-FSLF45-0608A	54303-0608A	20307101	5/16	FSL-08	1.30	33	1.85	47
GC-FSLF45-0808A	54303-0808A	20307102	13/32	FSL-08	1.30	33	1.30	33
GC-FSLF45-1210A	54303-1210A	20307104	5/8	FSL-10	1.42	36	1.61	41
GC-FSLF45-1212A	54303-1212A	20307105	5/8	FSL-12	1.42	36	1.61	41



Ford Spring Lock

Female / 90° Elbow

Part Number	Product Number	SAP Number						
			Hose ID	Thread Size (A)	Drop (D)		Cut-Off (R)	
			in.		in.	mm	in.	mm
GC-FSLF90-0606A	54305-0606A	20306845	5/16	FSL-06	2.13	54	1.97	50
GC-FSLF90-0608A	54305-0608A	20307106	5/16	FSL-08	2.13	54	1.97	50
GC-FSLF90-1010A	54305-1010A	20306847	1/2	FSL-10	2.52	64	2.36	60
GC-FSLF90-1210A	54305-1210A	20307107	5/8	FSL-10	2.52	64	2.36	60

GC (COOL CLIP®) FITTINGS FOR GALAXY® G4890

Ford Spring Lock

Male

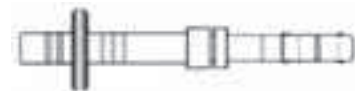

Part Number	Product Number	SAP Number	Hose ID	Thread Size (A)	Cut-Off (R)	
			in.		in.	mm
GC-FSLM-0606A	54330-0606A	20306849	5/16	FSL-06	2.72	69
GC-FSLM-1010A	54330-1010A	20306851	1/2	FSL-10	2.99	76
GC-FSLM-1210A	54330-1210A	20306852	5/8	FSL-10	2.99	76
GC-FSLM-1212A	54330-1212A	20306853	5/8	FSL-12	3.11	79

Ford Spring Lock

Male / 45° Elbow



Part Number	Product Number	SAP Number	Hose ID	Thread Size (A)	Drop (D)		Cut-Off (R)	
			in.		in.	mm	in.	mm
GC-FSLM45-0608A	54333-0608A	20307110	5/16	FSL-08	1.30	33	1.85	47
GC-FSLM45-0808A	54333-0808A	20307111	13/32	FSL-08	1.26	32	1.30	33
GC-FSLM45-1010A	54333-1010A	20307112	1/2	FSL-10	1.42	36	1.61	41
GC-FSLM45-1210A	54333-1210A	20307113	5/8	FSL-10	1.42	36	1.61	41
GC-FSLM45-1212A	54333-1212A	20307114	5/8	FSL-12	1.42	36	1.61	41



Download the **MyCrimp App** for more information.

Section 8
GC Fittings

FITTINGS



GC (COOL CLIP®) FITTINGS FOR GALAXY® G4890

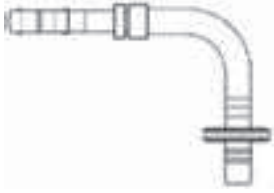

Ford Spring Lock

Male / 90° Elbow



Part Number	Product Number	SAP Number	Hose ID	Thread Size (A)	Drop (D)		Cut-Off (R)	
					in.	mm	in.	mm
GC-FSLM90-0606A	54335-0606A	20307115	5/16	FSL-06	2.13	54	1.97	50
GC-FSLM90-1010A	54335-1010A	20307118	1/2	FSL-10	2.52	64	2.36	60
GC-FSLM90-1210A	54335-1210A	20307119	5/8	FSL-10	2.52	64	2.36	60
GC-FSLM90-1212A	54335-1212A	20307120	5/8	FSL-12	2.52	64	2.36	60



Hose Mender



Part Number	Product Number	SAP Number	Hose ID	Cut-Off (R)	
				in.	mm
GC-HM-0606	54350-0606	20306854	5/16	2.17	55
GC-HM-0608	54350-0608	20306855	5/16	2.17	55
GC-HM-0808	54350-0808	20306856	13/32	2.17	55
GC-HM-0810	54350-0810	20306857	13/32	2.17	55
GC-HM-1010	54350-1010	20306858	1/2	2.17	55
GC-HM-1210	54350-1210	20306859	5/8	2.17	55
GC-HM-1212	54350-1212	20306860	5/8	2.17	55

GC (COOL CLIP®) FITTINGS FOR GALAXY® G4890

Hose Mender

90° Elbow

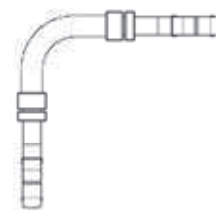

Part Number	Product Number	SAP Number	Hose ID		Drop (D)		Cut-Off (R)	
			in.	mm	in.	mm	in.	mm
GC-HM90-0606	54355-0606	20306861	5/16	24	0.94	24	0.94	24
GC-HM90-0808	54355-0808	20306862	13/32	29	1.14	29	1.14	29
GC-HM90-1010	54355-1010	20306863	1/2	34	1.34	34	1.34	34
GC-HM90-1212	54355-1212	20306864	5/8	39	1.54	39	1.54	39

Hose Mender

180° Elbow



Part Number	Product Number	SAP Number	Hose ID		Drop (D)		Cut-Off (R)	
			in.	mm	in.	mm	in.	mm
GC-HM180-0606	54360-0606	20306865	5/16	50	1.97	50	2.48	63
GC-HM180-0808	54360-0808	20306866	13/32	60	2.36	60	2.48	63
GC-HM180-1010	54360-1010	20306867	1/2	70	2.76	70	2.83	72
GC-HM180-1212	54360-1212	20306868	5/8	80	3.15	80	3.50	89

Hose Mender

R12 Valve



Drawing has R134a Valve
Fittings have R12 Valve



Part Number	Product Number	SAP Number	Hose ID		Cut-Off (R)		Valve (V)	
			in.	mm	in.	mm	in.	mm
GC-HM12V-0606	54365-0606	20306869	5/16	55	2.17	55	1/4	6.35
GC-HM12V-0808	54365-0808	20306870	13/32	55	2.17	55	1/4	6.35
GC-HM12V-1010	54365-1010	20306871	1/2	55	2.17	55	1/4	6.35
GC-HM12V-1212	54365-1212	20306872	5/8	55	2.17	55	1/4	6.35



Download the **MyCrimp App** for more information.

Section 8
GC Fittings

FITTINGS



GC (COOL CLIP®) FITTINGS FOR GALAXY® G4890

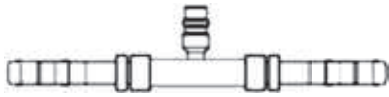

Hose Mender

R134a Valve



Part Number	Product Number	SAP Number	Hose ID		Cut-Off (R)		Valve (V)	
			in.	mm	in.	mm	in.	mm
GC-HM134V-0606	54370-0606	20306873	5/16	15.9	2.17	55	0.63	16
GC-HM134V-0808	54370-0808	20306874	13/32	41.3	2.17	55	0.63	16
GC-HM134V-1010	54370-1010	20306875	1/2	12.7	2.17	55	0.51	13
GC-HM134V-1212	54370-1212	20306876	5/8	15.9	2.17	55	0.51	13

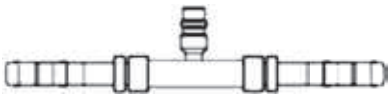

Fitting has sight glass in place of R134a valve

Hose Mender with Sight Glass



Part Number	Product Number	SAP Number	Hose ID		Cut-Off (R)	
			in.	mm	in.	mm
GC-HMSG-0606	54375-0606	20307121	5/16	15.9	2.48	63

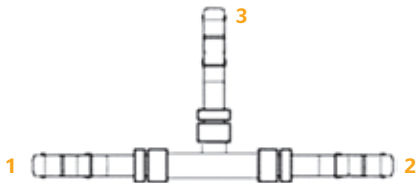

Hose Mender, Tee



Part Number	Product Number	SAP Number	Hose ID		Drop (D)		Cut-Off (R)	
			Hose ID 1 & 2	Hose ID 3	in.	mm	in.	mm
GC-HMT-0606	54380-0606	20306877	5/16	5/16	1.22	31	2.44	62
GC-HMT-0808	54380-0808	20306878	13/32	13/32	1.30	33	2.60	66
GC-HMT-1010	54380-1010	20306879	1/2	1/2	1.73	44	2.72	69
GC-HMT-1210	54380-1210	20307122	5/8	1/2	1.73	44	2.72	69
GC-HMT-1212	54380-1212	20306880	5/8	5/8	1.73	44	2.95	75

GC (COOL CLIP®) FITTINGS FOR GALAXY® G4890

O-Ring Face Seal

Female / Swivel

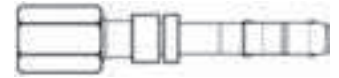

Part Number	Product Number	SAP Number	Hose ID		Cut-Off (R)	
			in.	mm	in.	mm
GC-OFFX-0606	54430-0606	20307123	5/16	11/16-16	1.77	45
GC-OFFX-0808	54430-0808	20307124	13/32	13/16-16	1.97	50
GC-OFFX-1010	54430-1010	20307125	1/2	1-14	2.48	63
GC-OFFX-1212	54430-1212	20307126	5/8	1 3/8-12	2.72	69

O-Ring Face Seal

Female / Swivel / 90° Elbow

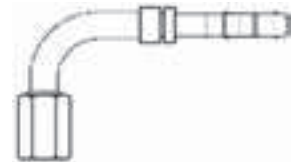

Part Number	Product Number	SAP Number	Hose ID		Drop (D)		Cut-Off (R)	
			in.	mm	in.	mm	in.	mm
GC-OFFX90-0606	54435-0606	20306881	5/16	1 1/8-16	1.14	29	0.94	24
GC-OFFX90-0808	54435-0808	20306882	13/32	1 3/8-16	1.34	34	1.14	29
GC-OFFX90-1010	54435-1010	20307127	1/2	1-14	1.57	40	1.34	34
GC-OFFX90-1212	54435-1212	20307128	5/8	1 3/8-12	1.81	46	1.54	39

O-Ring Insert

Male



Part Number	Product Number	SAP Number	Hose ID		Cut-Off (R)	
			in.	mm	in.	mm
GC-OIM-0606	54500-0606	20306887	5/16	5/8-18	2.80	71
GC-OIM-0808	54500-0808	20306888	13/32	3/4-16	2.91	74
GC-OIM-1010	54500-1010	20306889	1/2	7/8-14	2.13	54
GC-OIM-1210	54500-1210	20306890	5/8	7/8-14	2.13	54
GC-OIM-1212	54500-1212	20306891	5/8	1 1/8-14	3.31	84



Download the **MyCrimp App** for more information.

Section 8
GC Fittings

FITTINGS



GC (COOL CLIP®) FITTINGS FOR GALAXY® G4890

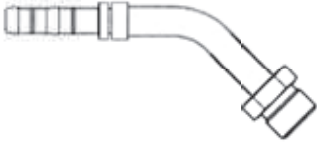

O-Ring Insert

Male / 45° Elbow



Part Number	Product Number	SAP Number	Hose ID	Thread Size (A)	Drop (D)		Cut-Off (R)	
			in.		in.	mm	in.	mm
GC-OIM45-0606	54503-0606	20307130	5/16	5/8-18	0.75	19	1.18	30
GC-OIM45-0808	54503-0808	20307131	13/32	3/4-16	0.94	24	1.30	33
GC-OIM45-1010	54503-1010	20307132	1/2	7/8-14	1.26	32	1.61	41
GC-OIM45-1212	54503-1212	20307133	5/8	1 1/6 -14	1.38	35	1.77	45

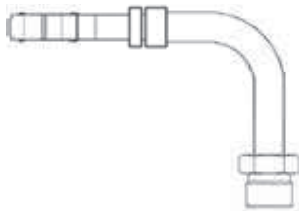

O-Ring Insert

Male / 90° Elbow



Part Number	Product Number	SAP Number	Hose ID	Thread Size (A)	Drop (D)		Cut-Off (R)	
			in.		in.	mm	in.	mm
GC-OIM90-0606	54505-0606	20306892	5/16	5/8-18	1.38	35	2.13	54
GC-OIM90-0808	54505-0808	20306893	13/32	3/4-16	1.73	44	1.61	41
GC-OIM90-1010	54505-1010	20306894	1/2	7/8-14	2.17	55	2.32	59
GC-OIM90-1210	54505-1210	20307134	5/8	7/8-14	2.17	55	2.32	59
GC-OIM90-1212	54505-1212	20307135	5/8	1 1/6 -14	2.76	70	2.32	59

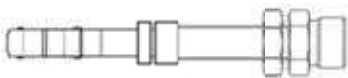

O-Ring Insert

Male / Bulkhead



Part Number	Product Number	SAP Number	Hose ID	Thread Size (A)	Cut-Off (R)	
			in.		in.	mm
GC-OIMB-0808	54515-0808	20307137	13/32	3/4-16	3.15	80
GC-OIMB-1010	54515-1010	20307138	1/2	7/8-14	3.15	80

GC (COOL CLIP®) FITTINGS FOR GALAXY® G4890

O-Ring Insert

Male / Bulkhead / 90° Elbow

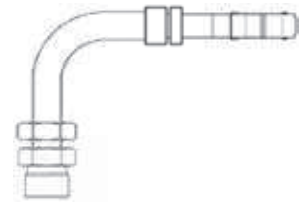

Part Number	Product Number	SAP Number	Hose ID	Thread Size (A)	Drop (D)		Cut-Off (R)	
			in.		in.	mm	in.	mm
GC-OIMB90-0606	54520-0606	20307139	5/16	5/8-18	2.13	54	1.97	50
GC-OIMB90-1010	54520-1010	20307141	5/8	7/8-14	2.52	64	2.36	60

O-Ring Insert

Male / R134a Valve

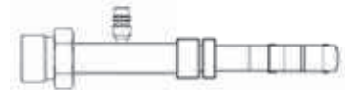

Part Number	Product Number	SAP Number	Hose ID	Thread Size (A)	Cut-Off (R)		Valve (V)	
			in.		in.	mm	in.	mm
GC-OIM134V-0606	54530-0606	20307142	5/16	5/8-18	2.80	71	0.63	16
GC-OIM134V-0808	54530-0808	20307143	13/32	3/4-16	2.91	74	0.63	16
GC-OIM134V-1010	54530-1010	20307144	1/2	7/8-14	2.13	54	0.51	13
GC-OIM134V-1212	54530-1212	20307145	5/8	1 1/8-14	3.31	84	0.51	13

O-Ring Insert

Male / 90° Elbow / R134a Valve

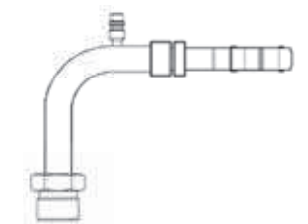

Part Number	Product Number	SAP Number	Hose ID	Thread Size (A)	Drop (D)		Cut-Off (R)		Valve (V)	
			in.		in.	mm	in.	mm	in.	mm
GC-OIM134V90-0606	54535-0606	20307146	5/16	5/8-18	1.38	35	2.13	54	0.63	16
GC-OIM134V90-0808	54535-0808	20307147	13/32	3/4-16	1.73	44	1.61	41	0.63	16
GC-OIM134V90-1010	54535-1010	20307148	1/2	7/8-14	2.17	55	2.32	59	0.51	13



Download the **MyCrimp App** for more information.

Section 8
GC Fittings

FITTINGS



GC (COOL CLIP®) FITTINGS FOR GALAXY® G4890

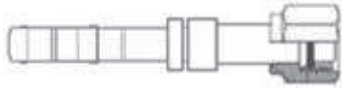

O-Ring Tube

Female / Swivel



Part Number	Product Number	SAP Number	Hose ID	Thread Size (A)	Cut-Off (R)	
			in.		in.	mm
GC-OTF-0605	54600-0605	20307149	5/16	9/16-18	1.42	36
GC-OTF-0606	54600-0606	20306895	5/16	5/8-18	1.42	36
GC-OTF-0608	54600-0608	20306896	5/16	3/4-16	1.57	40
GC-OTF-0806	54600-0806	20307150	13/32	5/8-18	1.57	40
GC-OTF-0808	54600-0808	20306897	13/32	3/4-16	1.57	40
GC-OTF-1008	54600-1008	20307151	1/2	3/4-16	1.57	40
GC-OTF-1010	54600-1010	20306898	1/2	7/8-14	1.97	50
GC-OTF-1012	54600-1012	20307152	1/2	1 1/6 -14	2.09	53
GC-OTF-1210	54600-1210	20306899	5/8	7/8-14	1.97	50
GC-OTF-1212	54600-1212	20306900	5/8	1 1/6 -14	2.09	53



O-Ring Tube

Female / 45° Elbow / Swivel







Part Number	Product Number	SAP Number	Hose ID	Thread Size (A)	Drop (D)		Cut-Off (R)	
			in.		in.	mm	in.	mm
GC-OTF45-0606	54603-0606	20306901	5/16	5/8-18	0.55	14	1.02	26
GC-OTF45-0806	54603-0806	20307153	13/32	5/8-18	0.55	14	1.02	26
GC-OTF45-0808	54603-0808	20306902	13/32	3/4-16	0.59	15	2.13	54
GC-OTF45-1008	54603-1008	20307154	1/2	3/4-16	0.59	15	2.13	54
GC-OTF45-1010	54603-1010	20306903	1/2	7/8-14	0.67	17	2.13	54
GC-OTF45-1210	54603-1210	20306904	5/8	7/8-14	0.67	17	2.13	54
GC-OTF45-1212	54603-1212	20306905	5/8	1 1/6 -14	1.18	30	2.13	54

GC (COOL CLIP®) FITTINGS FOR GALAXY® G4890

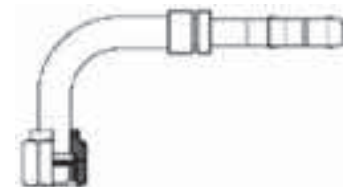
O-Ring Tube

Female / 90° Elbow / Swivel





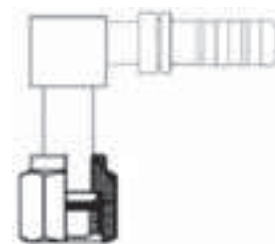

Part Number	Product Number	SAP Number						
			Hose ID	Thread Size (A)	Drop (D)		Cut-Off (R)	
			in.		in.	mm	in.	mm
GC-OTF90-0605	54605-0605	20307155	5/16	9/16-18	1.26	32	1.46	37
GC-OTF90-0606	54605-0606	20306906	5/16	5/8-18	1.26	32	1.46	37
GC-OTF90-0608	54605-0608	20306907	5/16	3/4-16	1.42	36	1.77	45
GC-OTF90-0806	54605-0806	20307156	13/32	5/8-18	1.65	42	2.17	55
GC-OTF90-0808	54605-0808	20306908	13/32	3/4-16	1.42	36	1.77	45
GC-OTF90-1008	54605-1008	20307157	1/2	3/4-16	1.42	36	1.77	45
GC-OTF90-1010	54605-1010	20306909	1/2	7/8-14	1.65	42	2.17	55
GC-OTF90-1012	54605-1012	20307158	1/2	1 1/16-14	1.77	45	2.40	61
GC-OTF90-1210	54605-1210	20306910	5/8	7/8-14	1.65	42	2.17	55
GC-OTF90-1212	54605-1212	20306911	5/8	1 1/16-14	1.77	45	2.40	61

O-Ring Tube

Female / 90° Block Elbow / Swivel



Part Number	Product Number	SAP Number						
			Hose ID	Thread Size (A)	Drop (D)		Cut-Off (R)	
			in.		in.	mm	in.	mm
GC-OTF90B-0808	54610-0808	20306912	13/32	3/4-16	0.91	23	2.32	59
GC-OTF90B-1010	54610-1010	20306913	1/2	7/8-14	0.94	24	2.32	59
GC-OTF90B-1210	54610-1210	20306914	5/8	7/8-14	0.94	24	2.32	59



Download the **MyCrimp App** for more information.

Section 8
GC Fittings

FITTINGS



GC (COOL CLIP®) FITTINGS FOR GALAXY® G4890

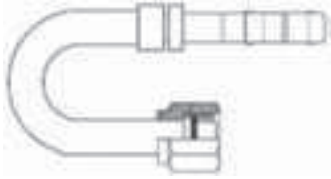

O-Ring Tube

Female / 180° Elbow / Swivel



Part Number	Product Number	SAP Number	Hose ID	Thread Size (A)	Drop (D)		Cut-Off (R)	
			in.		in.	mm	in.	mm
GC-OTF180-0606	54615-0606	20307159	5/16	5/8-18	1.97	50	2.48	63
GC-OTF180-0808	54615-0808	20307160	13/32	3/4-16	2.36	60	2.48	63
GC-OTF180-1212	54615-1212	20307161	5/8	1 1/6 -14	3.15	80	3.50	89

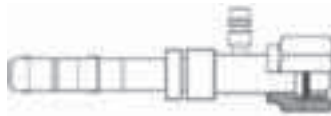

Drawing has R134a Valve
Fittings have R12 Valve

O-Ring Tube

Female / Swivel / R12 Valve



Part Number	Product Number	SAP Number	Hose ID	Thread Size (A)	Cut-Off (R)		Valve (V)	
			in.		in.	mm	in.	mm
GC-OTF12V-0606	54650-0606	20307162	5/16	5/8-18	1.42	36	1/4	6.35
GC-OTF12V-0808	54650-0808	20307163	13/32	3/4-16	1.57	40	1/4	6.35
GC-OTF12V-1010	54650-1010	20307164	1/2	7/8-14	1.97	50	1/4	6.35

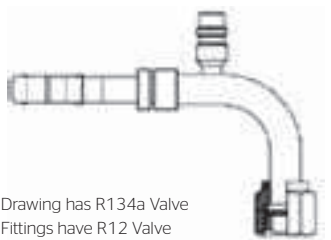

Drawing has R134a Valve
Fittings have R12 Valve

O-Ring Tube

Female / 90° Elbow / Swivel / R12 Valve







Part Number	Product Number	SAP Number	Hose ID	Thread Size (A)	Drop (D)		Cut-Off (R)		Valve (V)	
			in.		in.	mm	in.	mm	in.	mm
GC-OTF12V90-0606	54655-0606	20306915	5/16	5/8-18	1.26	32	1.46	37	1/4	6.35
GC-OTF12V90-0808	54655-0808	20306916	13/32	3/4-16	1.42	36	1.77	45	1/4	6.35
GC-OTF12V90-1010	54655-1010	20306917	1/2	7/8-14	1.65	42	2.17	55	1/4	6.35
GC-OTF12V90-1210	54655-1210	20306918	5/8	7/8-14	1.50	38	1.85	47	1/4	6.35

GC (COOL CLIP®) FITTINGS FOR GALAXY® G4890

O-Ring Tube

Female / Swivel / R134a Valve





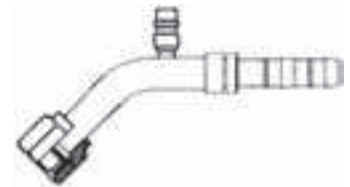

Part Number	Product Number	SAP Number						
			Hose ID	Thread Size (A)	Cut-Off (R)		Valve (V)	
			in.		in.	mm	in.	mm
GC-OTF134V-0606	54660-0606	20306919	5/16	5/8-18	1.42	36	0.63	16
GC-OTF134V-0808	54660-0808	20306920	13/32	3/4-16	1.57	40	0.63	16
GC-OTF134V-1010	54660-1010	20306921	1/2	7/8-14	1.97	50	0.51	13
GC-OTF134V-1210	54660-1210	20306922	5/8	7/8-14	1.97	50	0.51	13
GC-OTF134V-1212	54660-1212	20307165	5/8	1 1/6 -14	2.09	53	0.51	13
GC-OTF134VHS-1010	54675-1010	20307172	1/2	7/8-14	1.97	50	0.63	16

O-Ring Tube

Female / 45° Elbow / Swivel / R134a Valve



Part Number	Product Number	SAP Number								
			Hose ID	Thread Size (A)	Drop (D)		Cut-Off (R)		Valve (V)	
			in.		in.	mm	in.	mm	in.	mm
GC-OTF134V45-0606	54663-0606	20307166	5/16	5/8-18	0.55	14	1.34	34	0.63	16
GC-OTF134V45-0808	54663-0808	20307167	13/32	3/4-16	0.59	15	1.38	35	0.63	16
GC-OTF134V45-1010	54663-1010	20307168	1/2	7/8-14	0.67	17	1.42	36	0.51	13
GC-OTF134V45-1210	54663-1210	20306923	5/8	7/8-14	0.67	17	1.42	36	0.51	13
GC-OTF134V45-1212	54663-1212	20307169	5/8	1 1/6 -14	0.94	24	2.13	54	0.51	13



Download the **MyCrimp App**
for more information.

Section 8
GC Fittings

FITTINGS





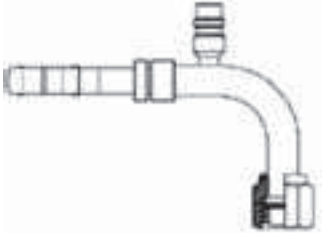

GC (COOL CLIP®) FITTINGS FOR GALAXY® G4890



O-Ring Tube



Female / 90° Elbow / Swivel / R134a Valve

Part Number	Product Number	SAP Number								
			Hose ID	Thread Size (A)	Drop (D)	Cut-Off (R)		Valve (V)		
			in.		in.	mm	in.	mm	in.	mm
GC-OTF134V90-0606	54665-0606	20306924	5/16	5/8-18	1.26	32	1.46	37	0.63	16
GC-OTF134V90-0806	54665-0806	20307170	13/32	5/8-18	1.26	32	1.46	37	0.63	16
GC-OTF134V90-0808	54665-0808	20306925	13/32	3/4-16	1.42	36	1.77	45	0.63	16
GC-OTF134V90-1010	54665-1010	20306926	1/2	7/8-14	1.65	42	2.17	55	0.51	13
GC-OTF134V90-1210	54665-1210	20306927	5/8	7/8-14	1.65	42	2.17	55	0.51	13
GC-OTF134V90-1212	54665-1212	20307171	5/8	1 1/6-14	1.77	45	2.40	61	0.51	13



O-Ring Tube

Male / Swivel





Part Number	Product Number	SAP Number				
			Hose ID	Thread Size (A)	Cut-Off (R)	
			in.		in.	mm
GC-OTM-0606	54700-0606	20306928	5/16	5/8-18	1.50	38
GC-OTM-0607	54700-0607	20306929	5/16	1 1/6-16	1.50	38
GC-OTM-0608	54700-0608	20306930	5/16	3/4-18	1.54	39
GC-OTM-0806	54700-0806	20307173	13/32	5/8-18	1.54	39
GC-OTM-0808	54700-0808	20306931	13/32	3/4-18	2.09	53
GC-OTM-1010	54700-1010	20306932	1/2	7/8-18	2.17	55
GC-OTM-1012	54700-1012	20306933	1/2	1 1/6-16	2.17	55
GC-OTM-1210	54700-1210	20306934	5/8	7/8-18	2.17	55
GC-OTM-1212	54700-1212	20306935	5/8	1 1/6-16	2.40	61

GC (COOL CLIP®) FITTINGS FOR GALAXY® G4890

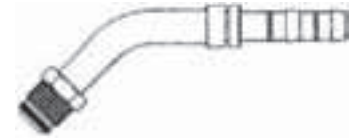
O-Ring Tube

Male / 45° Elbow / Swivel





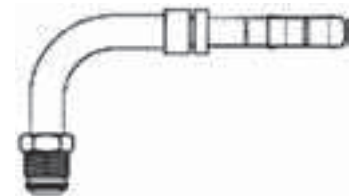

Part Number	Product Number	SAP Number						
			Hose ID	Thread Size (A)	Drop (D)		Cut-Off (R)	
			in.		in.	mm	in.	mm
GC-OTM45-0606	54703-0606	20306936	5/16	5/8-18	0.87	22	1.14	29
GC-OTM45-0608	54703-0608	20307174	5/16	3/4-18	0.87	22	1.14	29
GC-OTM45-0806	54703-0806	20307175	13/32	5/8-18	0.87	22	1.14	29
GC-OTM45-0808	54703-0808	20306937	13/32	3/4-18	0.98	25	1.42	36
GC-OTM45-1010	54703-1010	20306938	1/2	7/8-18	1.06	27	1.65	42
GC-OTM45-1210	54703-1210	20306939	5/8	7/8-18	1.18	30	1.81	46
GC-OTM45-1212	54703-1212	20306940	5/8	1 1/6-16	1.18	30	1.81	46

O-Ring Tube

Male / 90° Elbow / Swivel



Part Number	Product Number	SAP Number						
			Hose ID	Thread Size (A)	Drop (D)		Cut-Off (R)	
			in.		in.	mm	in.	mm
GC-OTM90-0606	54705-0606	20306941	5/16	5/8-18	1.46	37	1.38	35
GC-OTM90-0608	54705-0608	20306942	5/16	3/4-18	1.46	37	1.38	35
GC-OTM90-0806	54705-0806	20306943	13/32	5/8-18	1.46	37	1.38	35
GC-OTM90-0808	54705-0808	20306944	13/32	3/4-18	1.77	45	1.69	43
GC-OTM90-1010	54705-1010	20306945	1/2	7/8-18	2.05	52	2.01	51
GC-OTM90-1012	54705-1012	20306946	1/2	1 1/6-16	2.05	52	2.01	51
GC-OTM90-1210	54705-1210	20306947	5/8	7/8-18	2.05	52	2.01	51
GC-OTM90-1212	54705-1212	20306948	5/8	1 1/6-16	2.36	60	2.24	57



Download the **MyCrimp App**
for more information.

Section 8
GC Fittings

FITTINGS



GC (COOL CLIP®) FITTINGS FOR GALAXY® G4890



O-Ring Tube

Male / Swivel / Long Pilot

Part Number	Product Number	SAP Number	Hose ID		Thread Size (A)		Cut-Off (R)	
			in.	mm	in.	mm	in.	mm
GC-OTMLP-0606	54720-0606	20307176	5/16	13/32	5/8-18	1.50	38	
GC-OTMLP-0808	54720-0808	20307177	13/32	1/2	3/4-18	2.09	53	
GC-OTMLP-1010	54720-1010	20307178	1/2	5/8	7/8-18	2.17	55	
GC-OTMLP-1210	54720-1210	20307179	5/8	1 1/8	7/8-18	2.17	55	



O-Ring Tube

Male / Swivel / R134a Valve

Part Number	Product Number	SAP Number	Hose ID		Thread Size (A)		Cut-Off (R)		Valve (V)	
			in.	mm	in.	mm	in.	mm	in.	mm
GC-OTM134V-0606	54730-0606	20307180	5/16	13/32	5/8-18	1.42	36	0.63	16	
GC-OTM134V-0808	54730-0808	20307181	13/32	1/2	3/4-18	1.57	40	0.63	16	
GC-OTM134V-1010	54730-1010	20307182	1/2	5/8	7/8-18	1.97	50	0.51	13	
GC-OTM134V-1210	54730-1210	20306949	5/8	1 1/8	7/8-18	2.09	53	0.51	13	
GC-OTM134V-1212	54730-1212	20307183	5/8	1 1/8	1 1/8-16	2.09	53	0.51	13	

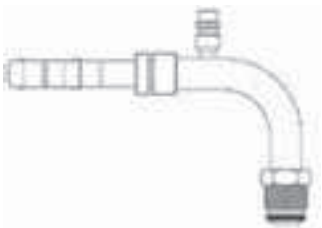

O-Ring Tube

Male / 90° Elbow / Swivel / R134a Valve

Part Number	Product Number	SAP Number	Hose ID		Thread Size (A)		Drop (D)		Cut-Off (R)		Valve (V)	
			in.	mm	in.	mm	in.	mm	in.	mm	in.	mm
GC-OTM134V90-1010	54735-1010	20307184	1/2	13/32	7/8-18	2.05	52	2.01	51	0.51	13	
GC-OTM134V90-1210	54735-1210	20306950	5/8	1 1/8	7/8-18	2.05	52	2.01	51	0.51	13	

GC (COOL CLIP®) FITTINGS FOR GALAXY® G4890

SAE 45° Flare

Female / Swivel

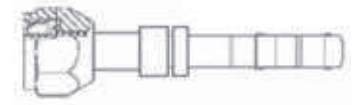

Part Number	Product Number	SAP Number	Hose ID	Thread Size (A)	Cut-Off (R)	
			in.		in.	mm
GC-SFFX-0606	54760-0606	20306951	5/16	5/8-18	1.73	44
GC-SFFX-0608	54760-0608	20306952	5/16	3/4-16	1.73	44
GC-SFFX-0806	54760-0806	20307185	13/32	5/8-18	2.13	54
GC-SFFX-0808	54760-0808	20306953	13/32	3/4-16	2.13	54
GC-SFFX-1008	54760-1008	20307186	1/2	3/4-16	2.13	54
GC-SFFX-1010	54760-1010	20306954	1/2	7/8-14	2.32	59
GC-SFFX-1210	54760-1210	20306955	5/8	7/8-14	2.32	59
GC-SFFX-1212	54760-1212	20306956	5/8	1 1/8-14	2.52	64

SAE 45° Flare

Female / 45° Elbow / Swivel

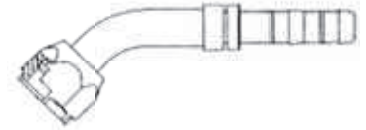

Part Number	Product Number	SAP Number	Hose ID	Thread Size (A)	Drop (D)		Cut-Off (R)	
			in.		in.	mm	in.	mm
GC-SFFX45-0606	54763-0606	20306957	5/16	5/8-18	0.79	20	2.52	64
GC-SFFX45-0608	54763-0608	20306958	5/16	3/4-16	0.79	20	2.52	64
GC-SFFX45-0806	54763-0806	20307187	13/32	5/8-18	0.79	20	2.52	64
GC-SFFX45-0808	54763-0808	20306959	13/32	3/4-16	0.79	20	2.72	69
GC-SFFX45-1008	54763-1008	20307188	1/2	3/4-16	0.79	20	2.72	69
GC-SFFX45-1010	54763-1010	20306960	1/2	7/8-14	0.87	22	2.72	69
GC-SFFX45-1210	54763-1210	20306961	5/8	7/8-14	0.87	22	2.72	69
GC-SFFX45-1212	54763-1212	20306962	5/8	1 1/8-14	0.87	22	2.72	69



Download the **MyCrimp App**
for more information.

Section 8
GC Fittings

FITTINGS



GC (COOL CLIP®) FITTINGS FOR GALAXY® G4890

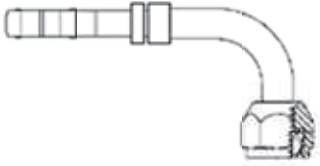

SAE 45° Flare

Female / 90° Elbow / Swivel



Part Number	Product Number	SAP Number	Hose ID	Thread Size (A)	Drop (D)		Cut-Off (R)	
			in.		in.	mm	in.	mm
GC-SFFX90-0606	54765-0606	20306963	5/16	5/8-18	1.18	30	1.73	44
GC-SFFX90-0608	54765-0608	20306964	5/16	3/4-16	1.18	30	1.73	44
GC-SFFX90-0806	54765-0806	20307189	13/32	5/8-18	1.18	30	1.73	44
GC-SFFX90-0808	54765-0808	20306965	13/32	3/4-16	1.77	45	1.73	44
GC-SFFX90-1008	54765-1008	20307190	1/2	3/4-16	1.77	45	1.73	44
GC-SFFX90-1010	54765-1010	20306966	1/2	7/8-14	1.77	45	2.13	54
GC-SFFX90-1210	54765-1210	20306967	5/8	7/8-14	1.77	45	2.13	54
GC-SFFX90-1212	54765-1212	20306968	5/8	1 1/16 -14	1.77	45	2.13	54

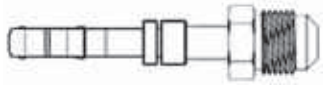

SAE 45° Flare

Male



Part Number	Product Number	SAP Number	Hose ID	Thread Size (A)	Cut-Off (R)	
			in.		in.	mm
GC-SFM-0606A	54780-0606	20306969	5/16	5/8-18	1.73	44
GC-SFM-0808A	54780-0808	20306970	13/32	3/4-16	1.73	44
GC-SFM-1010A	54780-1010	20306971	1/2	7/8-14	1.85	47
GC-SFM-1212A	54780-1212	20306972	5/8	1 1/16 -14	2.09	53

GC (COOL CLIP®) FITTINGS FOR GALAXY® G4890

SAE 45° Flare

Male / 45° Elbow

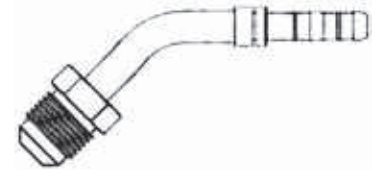

Part Number	Product Number	SAP Number	Hose ID	Thread Size (A)	Drop (D)		Cut-Off (R)	
			in.		in.	mm	in.	mm
GC-SFM45-0606A	54783-0606	20306973	5/16	5/8-18	0.75	19	1.73	44
GC-SFM45-0808A	54783-0808	20306974	13/32	3/4-16	0.94	24	1.73	44
GC-SFM45-1010A	54783-1010	20306975	1/2	7/8-14	1.26	32	2.13	54
GC-SFM45-1212A	54783-1212	20306976	5/8	1 1/8-14	1.38	35	2.13	54

SAE 45° Flare

Male / 90° Elbow

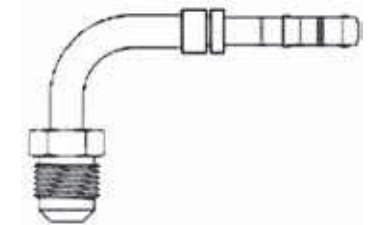

Part Number	Product Number	SAP Number	Hose ID	Thread Size (A)	Drop (D)		Cut-Off (R)	
			in.		in.	mm	in.	mm
GC-SFM90-0606A	54785-0606	20306977	5/16	5/8-18	1.18	30	1.73	44
GC-SFM90-0808A	54785-0808	20306978	13/32	3/4-16	1.77	45	1.73	44
GC-SFM90-1010A	54785-1010	20306979	1/2	7/8-14	1.77	45	2.13	54
GC-SFM90-1212A	54785-1212	20306980	5/8	1 1/8-14	1.77	45	2.13	54



Download the **MyCrimp App** for more information.

AC ADAPTERS



O-Ring Tube Compressor

Female to O-Ring Insert

Male / 90° Elbow / R134a Valve

Part Number	Product Number	SAP Number	Thread Size OTCF	Thread Size OIM
			in.	
AC-OTCF10-OIM08-90-134V	50900-1008	20307079	1-14	3/4-16
AC-OTCF10-OIM10-90-134V	50900-1010	20307080	1-14	7/8-14

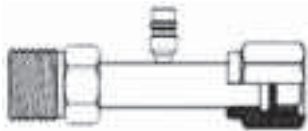

Drawing has R134a Valve
Fittings have R12 Valve

O-Ring Tube

Female to O-Ring Insert

Male / R12 Valve

Part Number	Product Number	SAP Number	Thread Size OTCF	Thread Size OIM
			in.	
AC-OTF06-OIM06-12V	50910-0606	20307081	5/8-18	5/8-18
AC-OTF08-OIM08-12V	50910-0808	20307082	3/4-16	3/4-16
AC-OTF10-OIM10-12V	50910-1010	20307083	7/8-14	7/8-14
AC-OTF12-OIM12-12V	50910-1212	20307084	1 1/16 -14	1 1/16 -14

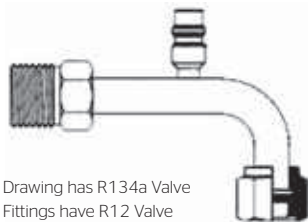

Drawing has R134a Valve
Fittings have R12 Valve

O-Ring Tube

Female to O-Ring Insert

Male / 90° Elbow / R12 Valve

Part Number	Product Number	SAP Number	Thread Size OTCF	Thread Size OIM
			in.	
AC-OTF06-OIM06-90-12V	50915-0606	20307085	5/8-18	5/8-18
AC-OTF08-OIM08-90-12V	50915-0808	20307086	3/4-16	3/4-16
AC-OTF10-OIM10-90-12V	50915-1010	20307087	7/8-14	7/8-14
AC-OTF12-OIM12-90-12V	50915-1212	20307088	1 1/16 -14	1 1/16 -14

FITTINGS



Section 8

AC Adapters

COMPATIBLE HOSE:

G4826 G4867 G4890

For a detailed list, please refer to your Crimp Specifications Manual.

O-Ring Tube Compressor

Female to O-Ring Insert
Male / R134a Valve

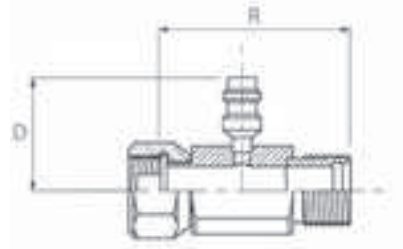

Part Number	Product Number	SAP Number	Thread Size OTCF	Thread Size OIM
			in.	
AC-OTF06-OIM06-134V	50920-0606	20306798	5/8-18	5/8-18
AC-OTF08-OIM08-134V	50920-0808	20306799	3/4-16	3/4-16
AC-OTF10-OIM10-134V	50920-1010	20306800	7/8-14	7/8-14
AC-OTF12-OIM12-134V	50920-1212	20306801	1 1/8 -14	1 1/8 -14

O-Ring Tube Compressor

Female to O-Ring Insert
Male / 90° Elbow / R134a Valve

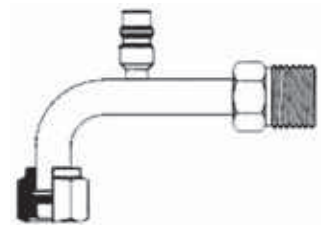

Part Number	Product Number	SAP Number	Thread Size OTCF	Thread Size OIM
			in.	
AC-OTF06-OIM06-90-134V	50925-0606	20306802	5/8-18	5/8-18
AC-OTF08-OIM08-90-134V	50925-0808	20306803	3/4-16	3/4-16
AC-OTF10-OIM10-90-134V	50925-1010	20306804	7/8-14	7/8-14



Download the **MyCrimp App**
for more information.

Section 8
AC Adapters

FITTINGS



AC FITTING ACCESSORIES

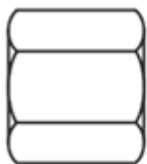

Flareless Tube Nuts

Part Number	Product Number	SAP Number	Thread Size	Tube OD
				in.
AC-FTN-0006	50250-0006	20306632	5/8-18	3/8
AC-FTN-0008	50250-0008	20306633	3/4-16	1/2
AC-FTN-0010	50250-0010	20306634	7/8-14	5/8
AC-FTN-0012	50250-0012	20306635	1 1/8-14	3/4



Flareless Tube Sleeves

Part Number	Product Number	SAP Number	Tube OD
			in.
AC-FTS-0006	50255-0006	20306636	3/8
AC-FTS-0008	50255-0008	20306637	1/2
AC-FTS-0010	50255-0010	20306638	5/8
AC-FTS-0012	50255-0012	20306639	3/4



Flareless Tube Sleeves Metric

Part Number	Product Number	SAP Number	Tube OD
			mm
AC-FTSM-0008	50260-0008	20306640	8.0
AC-FTSM-0012	50260-0012	20306641	12.0
AC-FTSM-0015	50260-0015	20306642	14.5

AC FITTING ACCESSORIES

Inline Orifice Tubes

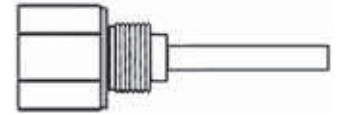

Part Number	Product Number	SAP Number	Orifice Tube OD		Orifice Tube Length		Description
			in.	mm	in.	mm	
AC-ILOTORA-0057	50401-0057	20306995	.057	1.4	3.50	88.9	Inline Orifice Tube, Ford, Orange
AC-ILOTRED-0062	50401-0062	20306996	.062	1.6	3.50	88.9	Inline Orifice Tube, Ford, Red
AC-ILOTBLU-0072	50401-0072	20306997	.072	1.8	3.50	88.9	Inline Orifice Tube, Ford, Blue
AC-ILOTBLK-0072	50402-0072	20306998	.072	1.8	3.50	88.9	Inline Orifice Tube, GM, Black
AC-ILOTWHI-0072	50403-0072	20306999	.072	1.8	3.50	88.9	Inline Orifice Tube, GM, White

O-Ring for Ford Spring Lock

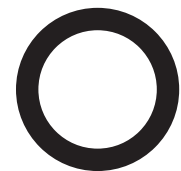

Part Number	Product Number	SAP Number	O-Ring ID	
			in.	mm
GC-OFSL-0006	54450-0006	20306556	3/8	9.5
GC-OFSL-0008	54450-0008	20306557	1/2	12.7
GC-OFSL-0010	54450-0010	20306558	5/8	15.9
GC-OFSL-0012	54450-0012	20306559	3/4	19.1

O-Ring for Switch

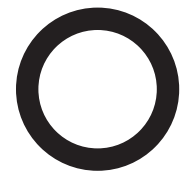

Part Number	Product Number	SAP Number	O-Ring ID	
			in.	mm
GC-OSWCH-0006	54455-0006	20307200	3/8	9.5



Download the **MyCrimp App** for more information.

Section 8
AC Accessories

FITTINGS



AC FITTING ACCESSORIES

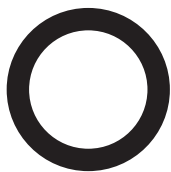

O-Ring for Tube Fittings

Part Number	Product Number	SAP Number	O-Ring ID		O-Ring Thickness	
			in.	mm	in.	mm
AC-OTUBE-0006	50460-0006	20306552	.30	7.6	0.07	1.8
AC-OTUBE-0008	50460-0008	20306553	.43	10.9	0.07	1.8
AC-OTUBE-0010	50460-0010	20306554	.55	14.0	0.07	1.8
AC-OTUBE-0012	50460-0012	20306555	.68	17.3	0.07	1.8



Sealing Washers

Part Number	Product Number	SAP Number	ID		Product Description
			in.		
AC-SWA-0012	50800-0012	20306787	3/4		Sealing Washer, Accumulator
AC-SWCN-0010	50803-0010	20306788	5/8		Sealing Washer, Compressor, Narrow
AC-SWCN-0012	50803-0012	20306789	3/4		Sealing Washer, Compressor, Narrow
AC-SWCW-0010	50805-0010	20306790	5/8		Sealing Washer, Compressor, Wide

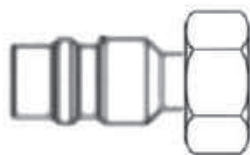

Valve Adapters

Part Number	Product Number	SAP Number	R12 Thread Size		R134a	Product Description
			in.	mm		
AC-VA12V3/16-134V16	50820-0001	20306791	3/8-24		16	Converts R12 to R134a Valve
AC-VA12V1/4-134V13	50820-0002	20306792	7/16-20		13	Converts R12 to R134a Valve
AC-VA12V1/4-134V16	50820-0003	20306793	7/16-20		16	Converts R12 to R134a Valve

AC FITTING ACCESSORIES

Valve Caps



Part Number	Product Number	SAP Number	Valve Style	Valve Size	
				in.	mm
AC-VC12V-0001	50830-0001	20306794	R12	1/4	
AC-VC134VHS-0002	50830-0002	20306795	R134a H.S.		16
AC-VC134VLS-0003	50830-0003	20306796	R134a L.S.		13

Valve Core



Part Number	Product Number	SAP Number	Thread Size
			in.
AC-VCORE-0001	50835-0001	20306797	0.210x36



Download the **MyCrimp App** for more information.

Section 8
AC Accessories

FITTINGS



AC FITTING ACCESSORIES



Metal Clip

Part Number	Product Number	SAP Number	Hose ID	
			in.	mm
GC-CLIP-0006	54850-0006	20306981	5/16	7.9
GC-CLIP-0008	54850-0008	20306982	13/32	10.3
GC-CLIP-0010	54850-0010	20306983	1/2	12.7
GC-CLIP-0012	54850-0012	20306984	5/8	15.9



Plastic Clip Holder

Part Number	Product Number	SAP Number	Hose ID	
			in.	mm
GC-CLIPHLDR-0006	54855-0006	20306985	5/16	7.9
GC-CLIPHLDR-0008	54855-0008	20306986	13/32	10.3
GC-CLIPHLDR-0010	54855-0010	20306987	1/2	12.7
GC-CLIPHLDR-0012	54855-0012	20306988	5/8	15.9

AC FITTING ACCESSORIES

Clip Pliers



Part Number	Product Number	SAP Number	Product Description
GC-PLIERS-0001	54860-0001	20306989	Clip Pliers for Assembly of Cool Clip Fittings

Hose Cutting Tool & Replacement Blades



Part Number	Product Number	SAP Number	Product Description
65090 HCT	65090	20038629	Hose Cutting Tool for G4890 Hose
65091 HCTRB	65091	20052606	Hose Cutting Tool Replacement Blades - 2/Pkg



Download the **MyCrimp App** for more information.

Section 8
AC Accessories

FITTINGS



SECTION 9 - UT FITTINGS

This section lists all fittings compatible with the following hose:

Hose	Description	Compatible Dash Size
DUT	SAE J1402 Type AI	All hose dash sizes

How to Use the Fittings Table

The fittings in this section will follow a similar table structure to the one seen on this page. Fitting dimensions and attributes are explained below.

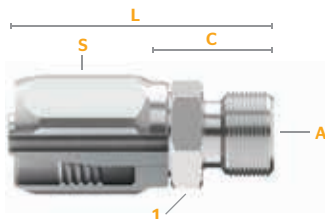

Fitting Name

Compatible Hose
Fitting Description

Part Number	Product Number	SAP Number	Hose ID		Thread Size (A)		Hex 1 Wrench Size		Hex 2 Wrench Size		(S) Socket Wrench Size	Cut-Off (C)		Length (L)	
			in.	mm	in.	mm	in.	mm	in.	mm	in.	mm	in.	mm	
UTFTM-0404	38360-0404	20419775	3/16	7/16-20	1/2	12.7	9/16	14.3	9/16	0.96	24.5	1.68	42.7		
UTFTM-0505	38360-0505	20419777	1/4	1/2-20	9/16	14.3	5/8	15.9	5/8	0.92	23.4	1.72	43.7		
UTFTM-0604	38360-0604	20419778	5/16	7/16-20	9/16	14.3	9/16	14.3	3/4	1.01	25.7	2.12	53.8		

Fitting Dimensions and Attributes

- Part Number** See Hydraulic Fittings Nomenclature on page 128 for a breakdown of part number attributes
- Hose ID** The compatible Hose ID
- Tube ID** The compatible Tube ID
- Thread Size** The thread size or sizes available for a particular fitting dash size (indicated by **A** in the fitting image)
- Hex Size** The wrench size for one or both nuts on the fitting (indicated by **1** or **2** in the fitting image)
- Drop** The length of the elbow (indicated by **D** in the fitting image)
- Cut-Off** The amount of hose to be cut for a correct assembly length (indicated by **C** in the fitting image)
- Length** The overall length of the fitting

Choose fittings carefully, considering the working pressure of both the hose and fitting. The maximum working pressure of the hose assembly is the lesser of the rated working pressure of the hose and the fitting. See page 389 for the Fittings Working Pressure Guide.

UT Fittings Overview

A complete overview of all UT fittings found in this section.

JIC 37° Flare (SAE J514)

Female
Swivel



UT-JCFX

P. 364

JIC 37° Flare (SAE J514)

Female
45° Elbow
Swivel



UT-JCFX45

P. 364

JIC 37° Flare (SAE J514)

Female
90° Elbow
Swivel



UT-JCFX90

P. 365

SAE 45° J512 Flare

Female
Swivel



UT-SFFX

P. 365

SAE 45° J512 Flare

Female
45° Elbow
Swivel



UT-SFFX45

P. 366

SAE 45° J512 Flare

Female
90° Elbow
Swivel



UT-SFFX90

P. 366

SAE 45° Inverted Flare

Male
Swivel



UT-SIMX

P. 367

SAE 45° Inverted Flare

Male
45° Elbow
Swivel



UT-SIMX45

P. 367

SAE 45° Inverted Flare (SAE J514)

Male
90° Elbow
Swivel



UT-SIMX90

P. 368

NPTF

Male



UT-NPM

P. 368

SAE J514 Flareless Tube Fittings

Male



UT-FTM

P. 369

Flange Engine Oil Connection (Two Bolt)

90° Elbow



UT-FL90EOC

P. 369

PTT 30°

Female
Swivel



UT-PTTFX

P. 369



Download the **MyCrimp App** for more information.

Section 9
UT Fittings





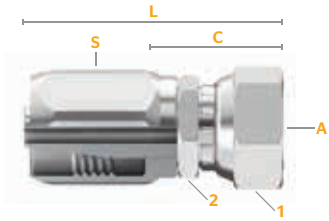

FITTINGS





JIC 37° Flare (SAE J514)

Female / Swivel





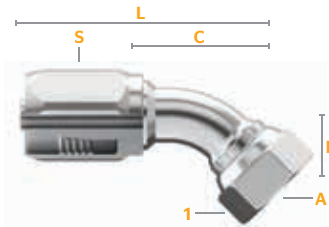



Part Number	Product Number	SAP Number											
			Hose ID	Thread Size (A)	Hex 1 Wrench Size	Hex 2 Wrench Size	(S) Socket Wrench Size	Cut-Off (C)	Length (L)				
			in.		in.	mm	in.	mm	in.	mm	in.	mm	
UT-JCFX-0404 ^{DS}	38400-0404	20419786	3/16	7/16-20	1/2	12.7	9/16	14.3	9/16	1.10	27.9	1.82	46.2
UT-JCFX-0505 ^{DS}	38400-0505	20419787	1/4	1/2-20	1/2	12.7	11/16	17.5	5/8	1.21	30.7	2.00	50.8
UT-JCFX-0606	38400-0606	20419788	5/16	9/16-18	3/4	19.1	3/4	19.1	3/4	1.19	30.2	2.04	51.8
UT-JCFX-0808 ^{DS}	38400-0808	20419789	13/32	3/4-16	7/8	22.2	7/8	22.2	7/8	1.45	36.8	2.45	62.2
UT-JCFX-1010 ^{DS}	38400-1010	20419801	1/2	7/8-14	1 1/16	27.0	1 1/16	27.0	1	1.65	41.9	2.72	69.1
UT-JCFX-1212	38400-1212	20419803	5/8	1 1/16-12	1 1/4	31.8	1 1/4	31.8	1 1/8	1.78	45.2	2.92	74.2
UT-JCFX-1616	38400-1616	20419804	7/8	1 3/8-12	1 1/2	38.1	1 1/2	38.1	1 3/8	1.84	46.7	2.90	73.7
UT-JCFX-2020	38400-2020	20419806	1 1/8	1 5/8-12	1 3/4	39.7	2	50.8	1 3/4	2.20	55.9	3.34	84.8

DS = Dual Seat (Connects to either SAE 45° or JIC 37° male fitting.)



JIC 37° Flare (SAE J514)

Female / 45° Elbow / Swivel







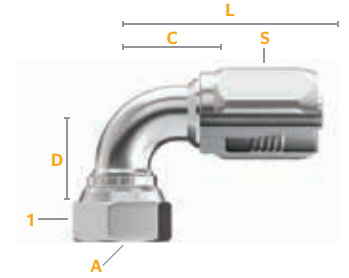

Part Number	Product Number	SAP Number													
			Hose ID	Thread Size (A)	Hex 1 Wrench Size	Hex 2 Wrench Size	(S) Socket Wrench Size	Drop (D)	Cut-Off (C)	Length (L)					
			in.		in.	mm	in.	mm	in.	mm	in.	mm			
UT-JCFX45-0404 ^{DS}	38420-0404	20419746	3/16	7/16-20	1/2	12.7	9/16	14.3	9/16	0.34	8.6	1.20	30.5	1.92	48.8
UT-JCFX45-0606	38420-0606	20419747	5/16	9/16-18	1/2	12.7	11/16	17.5	3/4	0.41	10.4	1.48	37.6	2.33	59.2
UT-JCFX45-0808 ^{DS}	38420-0808	20419749	13/32	3/4-16	7/8	17.5	7/8	22.2	7/8	0.56	14.2	1.73	43.9	2.73	69.3
UT-JCFX45-1010 ^{DS}	38420-1010	20419750	1/2	7/8-14	3/4	19.1	1	25.4	1	0.63	16.0	2.11	53.6	3.17	80.5
UT-JCFX45-1212	38420-1212	20419751	5/8	1 1/16-12	7/8	22.2	1 1/4	31.8	1 1/8	0.78	19.8	2.49	63.2	3.63	92.2

DS = Dual Seat (Connects to either SAE 45° or JIC 37° male fitting.)

JIC 37° Flare (SAE J514)

Female / 90° Elbow / Swivel









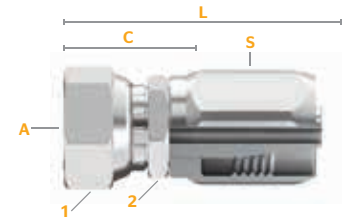

Part Number	Product Number	SAP Number													
			Hose ID	Thread Size (A)	Hex 1 Wrench Size	Hex 2 Wrench Size	(S) Socket Wrench Size	Drop (D)	Cut-Off (C)	Length (L)					
			in.		in.	mm	in.	mm	in.	mm	in.	mm			
UT-JCFX90-0404 ^{DS}	38425-0404	20419742	3/16	7/16-20	1/2	12.7	9/16	14.3	9/16	0.69	17.5	1.00	25.4	1.72	43.7
UT-JCFX90-0606	38425-0606	20419538	5/16	9/16-18	1/2	12.7	11/16	17.5	3/4	0.84	21.3	1.36	34.5	2.21	56.1
UT-JCFX90-0808 ^{DS}	38425-0808	20419743	13/32	3/4-16	11/16	17.5	7/8	22.2	7/8	1.09	27.7	1.54	39.1	2.54	64.5
UT-JCFX90-1010 ^{DS}	38425-1010	20419744	1/2	7/8-14	3/4	19.1	1	25.4	1	1.25	31.8	1.91	48.5	2.97	75.4
UT-JCFX90-1212	38425-1212	20419535	5/8	1 1/8-12	7/8	22.2	1 1/4	31.8	1 1/8	1.81	46.0	2.44	62.0	3.58	90.9
UT-JCFX90-1616	38425-1616	20419537	7/8	1 1/8-12	1 1/4	31.8	1 1/2	38.1	1 1/8	2.16	54.9	2.66	67.6	3.72	94.5

DS = Dual Seat (Connects to either SAE 45° or JIC 37° male fitting.)

SAE 45° J512 Flare

Female / Swivel



Part Number	Product Number	SAP Number											
			Hose ID	Thread Size (A)	Hex 1 Wrench Size	Hex 2 Wrench Size	(S) Socket Wrench Size	Cut-Off (C)	Length (L)				
			in.		in.	mm	in.	mm	in.	mm			
UTSFFX-0606	38775-0606	20419782	5/16	5/8-18	3/4	19.1	3/4	19.1	3/4	1.28	32.5	2.13	54.1
UTSFFX-1212	38775-1212	20419784	5/8	1 1/8-14	1 1/4	31.8	1 1/4	31.8	1 1/8	1.80	45.7	2.94	74.7



Download the **MyCrimp App** for more information.

Section 9
UT Fittings

FITTINGS



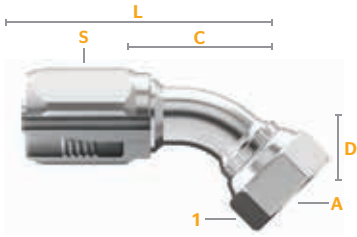

SAE 45° J512 Flare

Female / 45° Elbow / Swivel



Part Number	Product Number	SAP Number	Hose ID		Thread Size (A)		Hex 1 Wrench Size		Hex 2 Wrench Size		(S) Socket Wrench Size	Drop (D)		Cut-Off (C)		Length (L)	
			in.	mm	in.	mm	in.	mm	in.	mm	in.	mm	in.	mm	in.	mm	
UT-SFFX45-0606	38777-0606	20419748	5/16		5/8-18	1/2	12.7	3/4	19.1	3/4	0.41	10.4	1.48	37.6	2.33	59.2	
UT-SFFX45-1212	38777-1212	20419752	5/8		1 1/6-14	7/8	22.2	1 1/4	31.8	1 1/8	0.78	19.8	2.49	63.2	3.63	92.2	

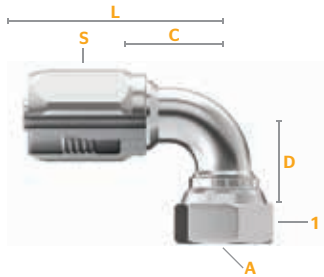

SAE 45° J512 Flare

Female / 90° Elbow / Swivel







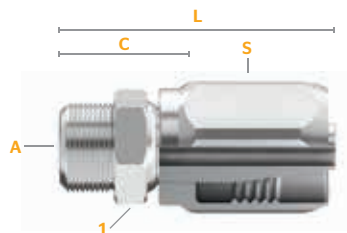

Part Number	Product Number	SAP Number	Hose ID		Thread Size (A)		Hex 1 Wrench Size		Hex 2 Wrench Size		(S) Socket Wrench Size	Drop (D)		Cut-Off (C)		Length (L)	
			in.	mm	in.	mm	in.	mm	in.	mm	in.	mm	in.	mm	in.	mm	
UT-SFFX90-0606	38780-0606	20419539	5/16		5/8-18	1/2	12.7	3/4	19.1	3/4	0.84	21.3	1.36	34.5	2.21	56.1	
UT-SFFX90-1212	38780-1212	20419536	5/8		1 1/6-14	7/8	22.2	1 1/4	31.8	1 1/8	1.81	46.0	2.44	62.0	3.58	90.9	

SAE 45° Inverted Flare

Male / Swivel









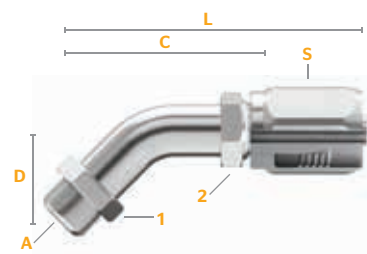

Part Number	Product Number	SAP Number											
			Hose ID	Thread Size (A)	Hex 1 Wrench Size	Hex 2 Wrench Size	(S) Socket Wrench Size	Cut-Off (C)	Length (L)				
			in.		in.	mm	in.	mm	in.	mm	in.	mm	
UTSIMX-0404	38800-0404	20419716	3/16	7/16-24	1/2	12.7	7/16	11.1	9/16	1.33	33.8	2.05	52.1
UTSIMX-0505	38800-0505	20419717	1/4	1/2-20	1/2	12.7	1/2	12.7	5/8	1.45	36.8	2.26	57.4
UTSIMX-0605	38800-0605	20419718	5/16	1/2-20	1/2	12.7	1/2	12.7	3/4	1.54	39.1	2.39	60.7
UTSIMX-0606	38800-0606	20419719	5/16	5/8-18	1/2	12.7	5/8	15.9	3/4	1.86	47.2	2.71	68.8
UTSIMX-0808	38800-0808	20419740	13/32	3/4-18	11/16	17.5	3/4	19.1	7/8	2.24	56.9	3.24	82.3

SAE 45° Inverted Flare

Male / 45° Elbow / Swivel



Part Number	Product Number	SAP Number													
			Hose ID	Thread Size (A)	Hex 1 Wrench Size	Hex 2 Wrench Size	(S) Socket Wrench Size	Drop (D)	Cut-Off (C)	Length (L)					
			in.		in.	mm	in.	mm	in.	mm	in.	mm			
UTSIMX45-0606	38810-0606	20419640	5/16	5/8-18	1/2	12.7	5/8	15.9	3/4	0.84	21.3	2.94	74.7	3.79	96.3
UTSIMX45-0808	38810-0808	20419741	13/32	3/4-18	1 1/16	17.5	3/4	19.1	7/8	1.09	27.7	3.24	82.3	4.24	107.7



Download the **MyCrimp App** for more information.

Section 9
UT Fittings

FITTINGS



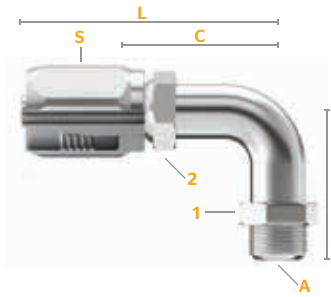

SAE 45° Inverted Flare (SAE J514)

Male / 90° Elbow / Swivel



Part Number	Product Number	SAP Number	Hose ID	Thread Size (A)	Hex 1 Wrench Size	Hex 2 Wrench Size	(S) Socket Wrench Size	Drop (D)	Cut-Off (C)	Length (L)
			in.		in. mm	in. mm	in.	in. mm	in. mm	in. mm
UT-SIMX90-0404	38815-0404	20419641	3/16	7/16-24	1/2 12.7	7/16 11.1	9/16	1.25 31.8	1.33 33.8	2.05 52.1
UT-SIMX90-0505	38815-0505	20419642	1/4	1/2-20	1/2 12.7	1/2 12.7	5/8	1.50 38.1	1.46 37.1	2.25 57.2
UT-SIMX90-0605	38815-0605	20419643	5/16	1/2-20	1/2 12.7	1/2 12.7	3/4	1.50 38.1	1.54 39.1	2.39 60.7
UT-SIMX90-0606	38815-0606	20419644	5/16	5/8-18	1/2 12.7	5/8 15.9	3/4	1.63 41.4	1.86 47.2	2.71 68.8
UT-SIMX90-0808	38815-0808	20419714	13/32	3/4-18	11/16 17.5	3/4 19.1	7/8	2.00 50.8	2.24 56.9	3.24 82.3

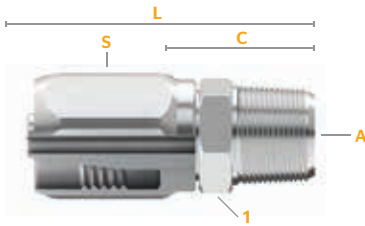

NPTF

Male

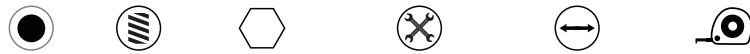

Part Number	Product Number	SAP Number	Hose ID	Thread Size (A)	Hex 1 Wrench Size	(S) Socket Wrench Size	Cut-Off (C)	Length (L)
			in.		in. mm	in.	in. mm	in. mm
UT-NPM-0402	38615-0402	20419753	3/16	1/8-27	1/2 12.7	9/16	0.81 20.6	1.53 38.9
UT-NPM-0404	38615-0404	20419754	3/16	1/4-18	9/16 14.3	9/16	1.03 26.2	1.75 44.5
UT-NPM-0504	38615-0504	20419755	1/4	1/4-18	9/16 14.3	5/8	0.96 24.4	1.76 44.7
UT-NPM-0604	38615-0604	20419756	5/16	1/4-18	9/16 14.3	3/4	1.00 25.4	1.85 47.0
UT-NPM-0606	38615-0606	20419757	5/16	3/8-18	11/16 17.5	3/4	1.04 26.4	1.89 48.0
UT-NPM-0806	38615-0806	20419758	13/32	3/8-18	11/16 17.5	7/8	1.19 30.2	2.19 55.6
UT-NPM-0808	38615-0808	20419759	13/32	1/2-14	7/8 22.2	7/8	1.29 32.8	2.29 58.2
UT-NPM-1008	38615-1008	20419770	1/2	1/2-14	7/8 22.2	1	1.31 33.3	2.38 60.5
UT-NPM-1212	38615-1212	20419771	5/8	3/4-14	1 1/16 27.0	1 1/8	1.44 36.6	2.59 65.8
UT-NPM-1612	38615-1612	20419773	7/8	3/4-14	1 1/16 27.0	1 3/8	1.43 36.3	2.49 63.2
UT-NPM-1616	38615-1616	20419772	7/8	1-11 1/2	1 3/8 34.9	1 3/8	1.74 44.2	2.80 71.1
UT-NPM-2020	38615-2020	20419774	1 1/8	1 1/4-11 1/2	1 3/8 44.5	1 3/8	1.80 45.7	2.92 74.2

SAE J514 Flareless Tube Fittings

Male

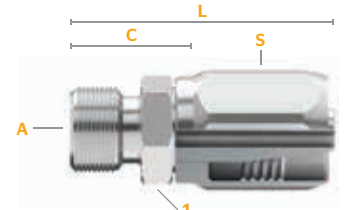

Part Number	Product Number	SAP Number											
			Hose ID	Thread Size (A)	Hex 1 Wrench Size	Hex 2 Wrench Size	(S) Socket Wrench Size	Cut-Off (C)	Length (L)				
			in.		in.	mm	in.	mm	in.	in.	mm	in.	mm
UTFTM-0404	38360-0404	20419775	3/16	7/16-20	1/2	12.7	9/16	14.3	9/16	0.96	24.5	1.68	42.7
UTFTM-0505	38360-0505	20419777	1/4	1/2-20	9/16	14.3	5/8	15.9	5/8	0.92	23.4	1.72	43.7
UTFTM-0604	38360-0604	20419778	5/16	7/16-20	9/16	14.3	9/16	14.3	3/4	1.01	25.7	2.12	53.8
UTFTM-0606	38360-0606	20419779	5/16	5/8-18	5/8	15.9	11/16	17.5	3/4	1.03	26.2	1.87	47.6
UTFTM-0808	38360-0808	20419780	13/32	3/4-16	13/16	20.6	7/8	22.2	7/8	1.15	29.2	2.15	54.6
UTFTM-1010	38360-1010	20419781	1/2	7/8-14	15/16	23.8	1	25.4	1	1.27	32.3	2.34	59.6

All Fittings come with Nut and Sleeve

Flange Engine Oil Connection (Two Bolt)

90° Elbow

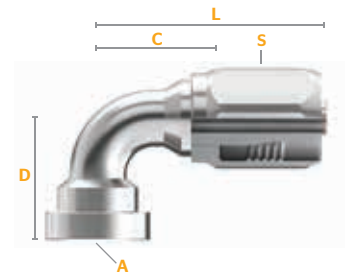

Part Number	Product Number	SAP Number												
			Hose ID	Thread Size (A)	Hex 1 Wrench Size	Hex 2 Wrench Size	(S) Socket Wrench Size	Drop (D)	Cut-Off (C)	Length (L)				
			in.		in.	mm	in.	mm	in.	in.	mm	in.	mm	
UTFL90EOC-2020	38351-2020	20419745	1 1/4	1 1/4	1 1/16	39.7	1 1/8	2.50	63.5	3.82	97.0	4.95	125.7	Y 52.1

UTFL90EOC-2020 includes engine connection flange clamp plate

PTT 30°

Female / Swivel

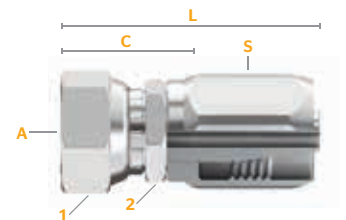

Part Number	Product Number	SAP Number											
			Hose ID	Thread Size (A)	Hex 1 Wrench Size	Hex 2 Wrench Size	(S) Socket Wrench Size	Cut-Off (C)	Length (L)				
			in.		in.	mm	in.	mm	in.	in.	mm	in.	mm
UTPTTFX-1616	38745-1616	20419805	7/8	1 1/16-14	1 1/2	38.1	1 1/2	38.1	1 3/8	1.68	42.7	2.74	69.6



Download the **MyCrimp App** for more information.

Section 9
UT Fittings

FITTINGS



SECTION 10 - SPECIALTY FITTINGS

This section lists all fittings compatible with the following hose:

Hose	Description	Compatible Dash Size	Hose	Description	Compatible Dash Size
NSFX	Saflex®	All hose dash sizes	IG	Insta-Grip™ 300 (Push-On)	All hose dash sizes
Hot Oiler	Prospector™ Hot Oiler	All hose dash sizes	IGHT	Insta-Grip™ HT 300 (Push-On)	All hose dash sizes
SGUN	Grease Gun Hose	All hose dash sizes	IGTC	Insta-Grip™ TC (Push-On)	All hose dash sizes
SHJ	Jack Hose	All hose dash sizes	FXG	FLEXAGrip™ 300 (Push-On)	All hose dash sizes

How to Use the Fittings Table

The fittings in this section will follow a similar table structure to the one seen on this page.



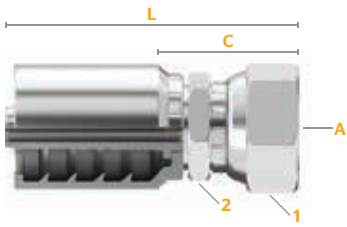

Fitting dimensions and attributes are explained below.



Fitting Name

Compatible Hose
Fitting Description

Compatible Hose - The Continental hose compatible with each fitting in this section is shown immediately below the Fitting Name. **Be sure to only use the fittings shown with the compatible hose listed.**

Part Number	Product Number	SAP Number								
			Hose ID	Thread Size (A)	Hex 1 Wrench Size	Cut-Off (C)		Length (L)		
			in.		in.	mm	in.	mm	in.	mm
PB-JCFX-0404	22400-0404	20282736	1/4	7-16-20	9/16	14	0.57	14.5	1.54	39.1
PB-JCFX-0606	22400-0606	20282740	3/8	9/16-18	3/4	19	0.62	15.8	1.70	43.2
PB-JCFX-0810	22400-0810	20283093	1/2	7/8-14	1	25	0.74	18.8	1.84	46.7

Fitting Dimensions and Attributes

Part Number See Hydraulic Fittings Nomenclature on page 128 for a breakdown of part number attributes

Hose ID The compatible Hose ID

Tube ID The compatible Tube ID

Thread Size The thread size or sizes available for a particular fitting dash size (indicated by **A** in the fitting image)

Hex Size The wrench size for one or both nuts on the fitting (indicated by **1** or **2** in the fitting image)

Drop The length of the elbow (indicated by **D** in the fitting image)

Cut-Off The amount of hose to be cut for a correct assembly length (indicated by **C** in the fitting image)

Length The overall length of the fitting

Skive Type For applicable fittings, a skive type will be indicated as Skive, Non-Skive or Dual-Grip

Choose fittings carefully, considering the working pressure of both the hose and fitting. The maximum working pressure of the hose assembly is the lesser of the rated working pressure of the hose and the fitting. See page 389 for the Fittings Working Pressure Guide.

FITTINGS



Section 10

Specialty Fittings

COMPATIBLE HOSE:

NSFX SHJ IGHT FXG SGUN
SHR IG IGTC Hot Oiler

For a detailed list, please refer to your Crimp Specifications Manual.

Specialty Fittings Overview

A complete overview of all specialty fittings found in this section.

JIC 37° Flare (SAE J514)

For Saflex® (NSFX) Hose
Female Swivel



SF-JCFX P. 372

NPTF

For Saflex® (NSFX) Hose
Male



SF-NPM P. 372

NPTF

For Saflex® (NSFX) Hose
Male Swivel



SF-NPMX P. 372

O-Ring Boss

For Saflex® (NSFX) Hose
Male



SF-OBM P. 373

O-Ring Boss

For Saflex® (NSFX) Hose
Male Swivel



SF-OBMX P. 373

NPT API

For Prospector™ SHR Hose
Male



B2-NPMAPI P. 374

IHUF Hammer Union



B2-IHUF P. 374

IHUM Hammer Union



B2-IHUM P. 374

NPTF

For Grease Gun (GG) Hose
Male



GG-NPM P. 375

NPTF

For Jack Hose (SHJ/"B2")
Male



B2-NPM P. 375

Hose Mender

For Push-On Brass (PB) Hose
Male



PB-HM P. 376

JIC 37° Flare

For Push-On Brass (PB) Hose
Female Swivel



PB-JCFX P. 376

JIC 37° Flare

For Push-On Brass (PB) Hose
Female 90° Elbow Swivel



PB-JCFX90 P. 377

JIC 37° Flare

For Push-On Brass (PB) Hose
Male



PB-JCM P. 377

NPTF

For Push-On Brass (PB) Hose
Female



PB-NPF P. 378

NPTF

For Push-On Brass (PB) Hose
Male

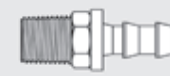

PB-NPM P. 378

NPTF

For Push-On Brass (PB) Hose
Male 90° Elbow

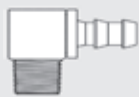

PB-NPM90 P. 379

NPTF

For Push-On Brass (PB) Hose
Male Swivel



PB-NPMX P. 379

SAE 45° Flare

For Push-On Brass (PB) Hose
Female Swivel



PB-SFFX P. 380

SAE 45° Flare

For Push-On Brass (PB) Hose
Male



PB-SFM P. 380

SAE 45° Inverted Flare

For Push-On Brass (PB) Hose
Female



PB-SIF P. 381

SAE 45° Inverted Flare

For Push-On Brass (PB) Hose
Male



PB-SIM P. 381



Download the **MyCrimp App** for more information.

Section 10
Specialty Fittings

FITTINGS



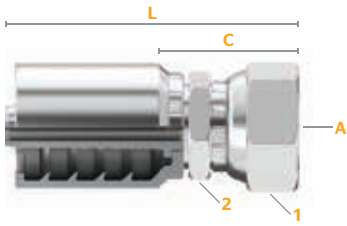

JIC 37° Flare (SAE J514)

SF (NSFX) fittings for Saflex®
Female / Swivel

Part Number	Product Number	SAP Number	Hose ID		Thread Size (A)		Hex 1 Wrench Size		Cut-Off (C)		Length (L)	
			in.	mm	in.	mm	in.	mm	in.	mm	in.	mm
SF-JCFX-0606	26400-0606	20766318	3/8		9/16-18		1 1/8	27			Contact Continental	

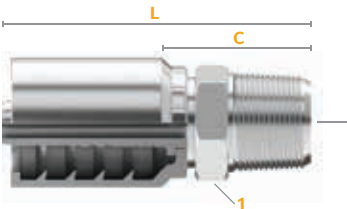

NPTF

SF (NSFX) fittings for Saflex®
Male

Part Number	Product Number	SAP Number	Hose ID		Thread Size (A)		Hex 1 Wrench Size		Cut-Off (C)		Length (L)	
			in.	mm	in.	mm	in.	mm	in.	mm	in.	mm
SF-NPM-0606	26615-0606	20285743	3/8		3/8-18		3/4	19	1.24	31.5	2.58	65.5
SF-NPM-0608	26615-0608	20413965	3/8		1/2-14		7/8	22	1.59	40.5	2.86	72.6
SF-NPM-0808	26615-0808	20352115	1/2		1/2-14		7/8	22	1.57	40.0	3.04	77.2

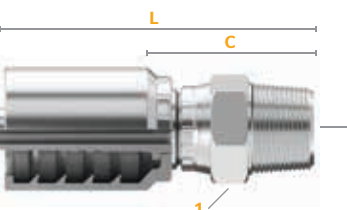

NPTF

SF (NSFX) fittings for Saflex®
Male / Swivel

Part Number	Product Number	SAP Number	Hose ID		Thread Size (A)		Hex 1 Wrench Size		Cut-Off (C)		Length (L)	
			in.	mm	in.	mm	in.	mm	in.	mm	in.	mm
SF-NPMX-0606	26645-0606	20347559	3/8		3/8-18		3/4	19	1.83	46.6	3.15	79.9
SF-NPMX-0808	26645-0808	20414341	1/2		1/2-14		7/8	22	1.76	44.6	3.26	82.8

FITTINGS



Section 10

Specialty Fittings

COMPATIBLE HOSE:





NSFX	SHJ	IGHT	FXG	SGUN
SHR	IG	IGTC	Hot Oilier	

For a detailed list, please refer to your Crimp Specifications Manual.

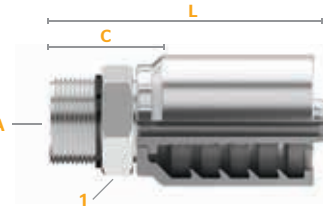
O-Ring Boss

SF (NSFX) fittings for Saflex®
Male





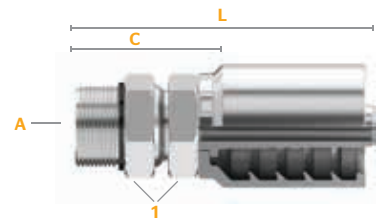

Part Number	Product Number	SAP Number								
			Hose ID	Thread Size (A)	Hex 1 Wrench Size		Cut-Off (C)	Length (L)		
			in.		in.	mm	in.	mm	in.	mm
SF-OBM-0608	26670-0608	20766320	3/8	3/4-16	7/8	22			Contact Continental	

O-Ring Boss

SF (NSFX) fittings for Saflex®
Male / Swivel



Part Number	Product Number	SAP Number								
			Hose ID	Thread Size (A)	Hex 1 Wrench Size		Cut-Off (C)	Length (L)		
			in.		in.	mm	in.	mm	in.	mm
SF-OBMX-0606	26680-0608	20766322	3/8	9/16-18	7/8	22			Contact Continental	
SF-OBMX-0608	26680-0608	20352114	3/8	3/4-16	7/8	22	1.73	44.0	3.00	76.3



Download the **MyCrimp App** for more information.

Section 10
Specialty Fittings

FITTINGS



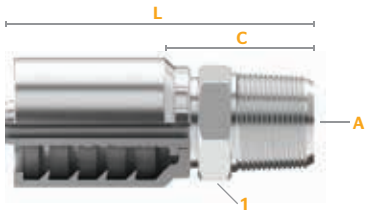

NPT API

For Prospector™ Slim Hole Rotary
Male



Part Number	Product Number	SAP Number	Hose ID	Thread Size (A)	Hex 1 Wrench Size		Cut-Off (C)		Length (L)	
			in.		in.	mm	in.	mm	in.	mm
B2-NPM-API-2424	28617-2424	20636530	1 ½	2-11 ½	2	51	3.072	78.0	5.4	137.2

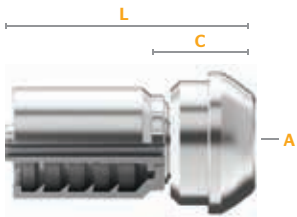

IHUF Fitting

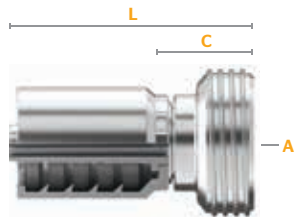

IHUM Fitting

NPT API Hammer Union

For Prospector™ Hot Oiler
Male



Part Number	Product Number	SAP Number	Hose ID	Thread Size (A)	Cut-Off (C)		Length (L)	
			in.		in.	mm	in.	mm
B2-IHUF1502-2432	28390-2432	20815350	1 ½	ACME-2G, 3 TPI	2.64	67.1	4.81	122.2
B2-IHUM1502-2432	28395-2432	20815351	1 ½	ACME-2G, 3 TPI	2.38	60.53	4.88	123.9

FITTINGS



Section 10

Specialty Fittings

COMPATIBLE HOSE:





NSFX	SHJ	IGHT	FXG	SGUN
SHR	IG	IGTC	Hot Oiler	

For a detailed list, please refer to your Crimp Specifications Manual.

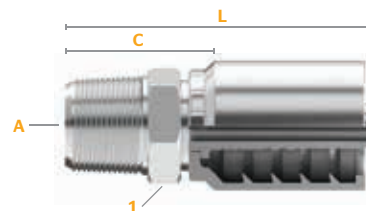
NPTF

GG (SGUN) fittings for Grease Gun Hose Male





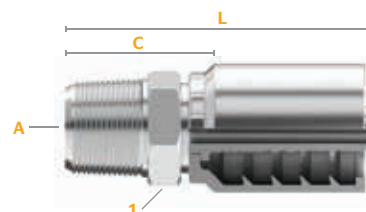

Part Number	Product Number	SAP Number								
			Hose ID	Thread Size (A)	Hex 1 Wrench Size	in.	mm	in.	mm	in.
GG-NPM-0302	20615-0302	20288023	3/16	1/8-27	5/8	15	0.38	9.7	1.38	35.1

NPTF

B2 (SHJ) fittings for Jack Hose Male



Part Number	Product Number	SAP Number								
			Hose ID	Thread Size (A)	Hex 1 Wrench Size	in.	mm	in.	mm	in.
B2-NPM-0402	14615-0402	20242110	1/4	1/8-27	9/16	14	0.88	22.3	1.85	47.1
B2-NPM-0404	14615-0404	20242111	1/4	1/4-18	11/16	17	1.06	27.0	2.15	54.6
B2-NPM-0404S	14615-0404S	20286649	1/4	1/4-18	11/16	17	1.06	27.0	2.15	54.6
B2-NPM-0406	14615-0406	20242109	1/4	3/8-18	3/4	19	1.04	26.3	2.01	51.1
B2-NPM-0408	14615-0408	20242115	1/4	1/2-14	7/8	22	1.31	33.3	2.29	58.1
B2-NPM-0604	14615-0604	20242067	3/8	1/4-18	11/16	17	1.04	26.3	2.09	53.0
B2-NPM-0606	14615-0606	20242069	3/8	3/8-18	3/4	19	1.04	26.4	2.09	53.1
B2-NPM-0606S	14615-0606S	20286830	3/8	3/8-18			1.10	27.9	2.05	52.0
B2-NPM-0608	14615-0608	20242079	3/8	1/2-14	7/8	22	1.27	32.3	2.32	59.0

S=Stainless Steel (See Fitting Identification in Appendix for more information.)



Download the **MyCrimp App** for more information.

Section 10
Specialty Fittings

FITTINGS



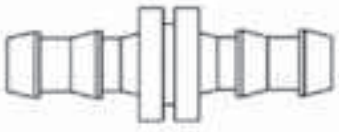

Hose Mender

PB (Push-On Brass) fittings for Insta-Grip™ and FXG
Male



Part Number	Product Number	SAP Number	Hose ID		Cut-Off (C)		Length (L)	
			in.	mm	in.	mm	in.	mm
PB-HM-0404	22380-0404	20282715	1/4	6.35	0.06	1.5	1.80	45.7
PB-HM-0505	22380-0505	20282716	5/16	7.94	0.06	1.5	1.80	45.7
PB-HM-0606	22380-0606	20282717	3/8	9.53	0.06	1.5	2.00	50.8
PB-HM-0808	22380-0808	20282718	1/2	12.70	0.06	1.5	2.00	50.8
PB-HM-1010	22380-1010	20283080	5/8	15.88	0.13	3.3	3.03	77.0
PB-HM-1212	22380-1212	20283081	3/4	19.05	0.13	3.3	3.03	77.0



JIC 37° Flare

PB (Push-On Brass) fittings for Insta-Grip™ and FXG
Female / Swivel



Part Number	Product Number	SAP Number	Hose ID		Hex 1 Wrench Size		Cut-Off (C)		Length (L)	
			in.	mm	in.	mm	in.	mm	in.	mm
PB-JCFX-0404	22400-0404	20282736	1/4	6.35	9/16	14	0.57	14.5	1.54	39.1
PB-JCFX-0405	22400-0405	20283092	1/4	6.35	5/8	16	0.60	15.1	1.57	39.9
PB-JCFX-0406	22400-0406	20282738	1/4	6.35	3/4	19	0.62	15.8	1.60	40.6
PB-JCFX-0605	22400-0605	20282739	3/8	9.53	5/8	16	0.60	15.1	1.67	42.4
PB-JCFX-0606	22400-0606	20282740	3/8	9.53	3/4	19	0.62	15.8	1.70	43.2
PB-JCFX-0608	22400-0608	20282741	3/8	9.53	7/8	22	0.75	19.0	1.85	47.0
PB-JCFX-0808	22400-0808	20282742	1/2	12.70	7/8	22	0.69	17.5	1.78	45.2
PB-JCFX-0810	22400-0810	20283093	1/2	12.70	1	25	0.74	18.8	1.84	46.7
PB-JCFX-1008	22400-1008	20283094	5/8	15.88	7/8	22	0.70	17.7	2.27	57.7
PB-JCFX-1010	22400-1010	20282745	5/8	15.88	1	25	0.75	19.0	2.33	59.2
PB-JCFX-1212	22400-1212	20283095	3/4	19.05	1 1/4	32	0.81	20.5	2.40	61.0
PB-JCFX-1616	22400-1616	20466036	1	25.40	1 1/2	38	1.13	28.7	2.57	65.3

FITTINGS



Section 10

Specialty Fittings

COMPATIBLE HOSE:





NSFX SHJ IGT FXG SGUN
SHR IG IGTC Hot Oilier

For a detailed list, please refer to your Crimp Specifications Manual.

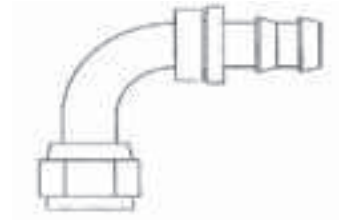
JIC 37° Flare

PB (Push-On Brass) fittings for Insta-Grip™ and FXG
Female / 90° Elbow / Swivel





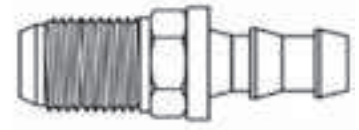

Part Number	Product Number	SAP Number								
			Hose ID	Thread Size (A)	Hex 1 Wrench Size		Cut-Off (C)		Drop (D)	
			in.		in.	mm	in.	mm	in.	mm
PB-JCFX90-0606	22425-0606	20450811	3/8	9/16-18	3/4	19	0.87	22.0	1.02	26.0

JIC 37° Flare

PB (Push-On Brass) fittings for Insta-Grip™ and FXG
Male



Part Number	Product Number	SAP Number								
			Hose ID	Thread Size (A)	Hex 1 Wrench Size		Cut-Off (C)		Length (L)	
			in.		in.	mm	in.	mm	in.	mm
PB-JCM-0404	22450-0404	20282768	1/4	7/16-20	1/2	13	0.70	17.8	1.57	39.9
PB-JCM-0406	22450-0406	20289525	1/4	9/16-18	5/8	16	0.77	19.6	1.64	41.7
PB-JCM-0606	22450-0606	20282769	3/8	9/16-18	5/8	16	0.81	20.6	1.78	45.2
PB-JCM-0808	22450-0808	20282771	1/2	3/4-16	3/4	19	1.00	25.4	1.97	50.0



Download the **MyCrimp App** for more information.

Section 10
Specialty Fittings



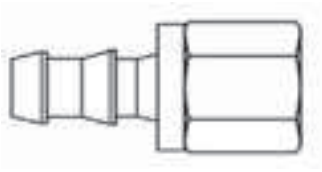

FITTINGS





NPTF



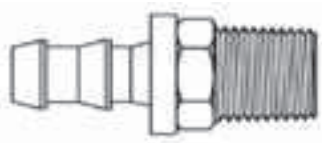

PB (Push-On Brass) fittings for Insta-Grip™ and FXG
Female

Part Number	Product Number	SAP Number								
			Hose ID	Thread Size (A)	Hex 1 Wrench Size		Cut-Off (C)		Length (L)	
			in.		in.	mm	in.	mm	in.	mm
PB-NPF-0402	22600-0402	20289527	1/4	1/8-27	1/2	13	0.41	10.4	1.35	34.3
PB-NPF-0404	22600-0404	20282772	1/4	1/4-18	5/8	16	0.54	13.8	1.51	38.4
PB-NPF-0504	22600-0504	20289528	5/16	1/4-18	5/8	16	0.54	13.8	1.51	38.4
PB-NPF-0604	22600-0604	20283105	3/8	1/4-18	5/8	16	0.54	13.8	1.61	40.9
PB-NPF-0606	22600-0606	20282774	3/8	3/8-18	3/4	19	0.56	14.3	1.63	41.4
PB-NPF-0806	22600-0806	20282775	1/2	3/8-18	3/4	19	0.56	14.3	1.63	41.4
PB-NPF-0808	22600-0808	20282776	1/2	1/2-14	15/16	24	0.68	17.3	1.77	45.0



NPTF

PB (Push-On Brass) fittings for Insta-Grip™ and FXG
Male

Part Number	Product Number	SAP Number								
			Hose ID	Thread Size (A)	Hex 1 Wrench Size		Cut-Off (C)		Length (L)	
			in.		in.	mm	in.	mm	in.	mm
PB-NPM-0402	22615-0402	20283096	1/4	1/8-27	1/2	13	0.56	14.2	1.43	36.3
PB-NPM-0404	22615-0404	20282748	1/4	1/4-18	9/16	14	0.79	20.1	1.66	42.2
PB-NPM-0406	22615-0406	20282749	1/4	3/8-18	11/16	17	0.79	20.1	1.66	42.2
PB-NPM-0504	22615-0504	20289529	5/16	1/4-18	9/16	14	0.79	20.1	1.66	42.2
PB-NPM-0602	22615-0602	20282750	3/8	1/8-27	1/2	13	0.56	14.2	1.53	38.9
PB-NPM-0604	22615-0604	20283097	3/8	1/4-18	9/16	14	0.79	20.1	1.76	44.7
PB-NPM-0606	22615-0606	20282752	3/8	3/8-18	11/16	17	0.79	20.1	1.76	44.7
PB-NPM-0608	22615-0608	20282753	3/8	1/2-14	7/8	22	1.00	25.4	1.97	50.0
PB-NPM-0804	22615-0804	20283098	1/2	1/4-18	11/16	17	0.79	20.1	1.76	44.7
PB-NPM-0806	22615-0806	20282755	1/2	3/8-18	11/16	17	0.79	20.1	1.76	44.7
PB-NPM-0808	22615-0808	20282756	1/2	1/2-14	7/8	22	1.00	25.4	1.97	50.0
PB-NPM-0812	22615-0812	20283099	1/2	3/4-14	1 1/16	27	1.00	25.4	1.97	50.0
PB-NPM-1006	22615-1006	20289540	5/8	3/8-18	3/4	19	0.89	22.6	2.34	59.4
PB-NPM-1008	22615-1008	20283100	5/8	1/2-14	7/8	22	1.00	25.4	2.45	62.2
PB-NPM-1012	22615-1012	20282759	5/8	3/4-14	1 1/16	27	1.00	25.4	2.45	62.2
PB-NPM-1208	22615-1208	20283101	3/4	1/2-14	7/8	22	1.00	25.4	2.45	62.2
PB-NPM-1212	22615-1212	20283102	3/4	3/4-14	1 1/16	27	1.00	25.4	2.45	62.2

FITTINGS



Section 10

Specialty Fittings

COMPATIBLE HOSE:





NSFX SHJ IGBT FXG SGUN
SHR IG IGTC Hot Oilier

For a detailed list, please refer to your Crimp Specifications Manual.

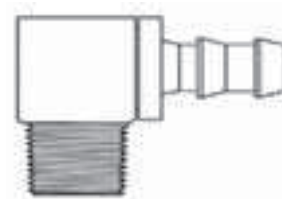
NPTF

PB (Push-On Brass) fittings for Insta-Grip™ and FXG Male / 90° Elbow





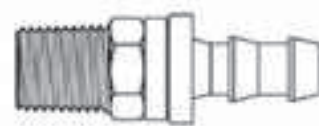

Part Number	Product Number	SAP Number						
			Hose ID	Thread Size (A)	Cut-Off (C)		Drop (D)	
			in.		in.	mm	in.	mm
PB-NPM90-0402	22625-0402	20283106	1/4	1/8-27	0.08	2.1	0.75	19.1
PB-NPM90-0404	22625-0404	20283107	1/4	1/4-18	0.13	3.2	0.95	24.1
PB-NPM90-0602	22625-0602	20289541	3/8	1/8-27	0.11	2.7	0.75	19.1
PB-NPM90-0604	22625-0604	20282779	3/8	1/4-18	0.12	3.1	0.90	22.9
PB-NPM90-0606	22625-0606	20282780	3/8	3/8-18	0.17	4.2	0.87	22.1
PB-NPM90-0806	22625-0806	20282782	1/2	3/8-18	0.40	10.1	1.19	30.2
PB-NPM90-0808	22625-0808	20283109	1/2	1/2-14	0.40	10.1	1.19	30.2
PB-NPM90-1008	22625-1008	20289542	5/8	1/2-14	0.40	10.1	1.19	30.2
PB-NPM90-1012	22625-1012	20289543	5/8	3/4-14	0.47	11.8	1.28	32.5
PB-NPM90-1212	22625-1212	20282784	3/4	3/4-14	0.47	11.8	1.28	32.5

NPTF

PB (Push-On Brass) fittings for Insta-Grip™ and FXG Male / Swivel



Part Number	Product Number	SAP Number								
			Hose ID	Thread Size (A)	Hex 1 Wrench Size		Cut-Off (C)		Length (L)	
			in.		in.	mm	in.	mm	in.	mm
PB-NPMX-0404	22645-0404	20282762	1/4	1/4-18	9/16	14	1.15	29.2	2.02	51.3
PB-NPMX-0604	22645-0604	20283103	3/8	1/4-18	9/16	14	1.15	29.2	2.12	53.9
PB-NPMX-0606	22645-0606	20282764	3/8	3/8-18	11/16	17	1.15	29.2	2.12	53.9
PB-NPMX-0806	22645-0806	20282765	1/2	3/8-18	11/16	17	1.15	29.2	2.12	53.9
PB-NPMX-0808	22645-0808	20282766	1/2	1/2-14	7/8	22	1.36	34.5	2.33	59.2
PB-NPMX-1212	22645-1212	20283104	3/4	3/4-14	1 1/8	27	1.35	34.3	2.80	71.1



Download the **MyCrimp App** for more information.

Section 10
Specialty Fittings



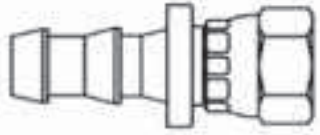

FITTINGS





SAE 45° Flare



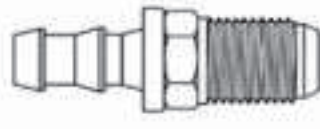

PB (Push-On Brass) fittings for Insta-Grip™ and FXG
Female / Swivel

Part Number	Product Number	SAP Number								
			Hose ID	Thread Size (A)	Hex 1 Wrench Size		Cut-Off (C)		Length (L)	
			in.		in.	mm	in.	mm	in.	mm
PB-SFFX-0405	22775-0405	20289551	1/4	1/2-20	5/8	16	0.60	15.1	1.57	39.9
PB-SFFX-0406	22775-0406	20289552	1/4	5/8-18	3/4	19	0.65	16.4	1.63	41.4
PB-SFFX-0506	22775-0506	20289553	5/16	5/8-18	3/4	19	0.65	16.4	1.63	41.4
PB-SFFX-0606	22775-0606	20282722	3/8	5/8-18	3/4	19	0.65	16.4	1.73	43.9
PB-SFFX-0608	22775-0608	20289554	3/8	3/4-16	7/8	22	0.75	19.0	1.85	47.0
PB-SFFX-0806	22775-0806	20289555	1/2	5/8-18	7/8	22	0.81	20.5	1.92	48.8
PB-SFFX-0808	22775-0808	20283083	1/2	3/4-16	7/8	22	0.64	16.2	1.72	43.7
PB-SFFX-0810	22775-0810	20289556	1/2	7/8-14	1	25	0.74	18.8	1.84	46.7
PB-SFFX-1008	22775-1008	20289557	5/8	3/4-16	7/8	22	0.70	17.7	2.27	57.7
PB-SFFX-1010	22775-1010	20283084	5/8	7/8-14	1	25	0.75	19.0	2.33	59.2
PB-SFFX-1212	22775-1212	20282725	3/4	1 1/16-14	1 1/4	32	0.82	20.9	2.42	61.5



SAE 45° Flare





PB (Push-On Brass) fittings for Insta-Grip™ and FXG
Male

Part Number	Product Number	SAP Number								
			Hose ID	Thread Size (A)	Hex 1 Wrench Size		Cut-Off (C)		Length (L)	
			in.		in.	mm	in.	mm	in.	mm
PB-SFM-0606	22785-0606	20282770	3/8	5/8-18	5/8	16	0.86	21.8	1.83	46.5

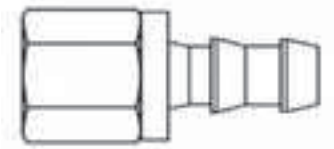
SAE 45° Inverted Flare

PB (Push-On Brass) fittings for Insta-Grip™ and FXG
Female





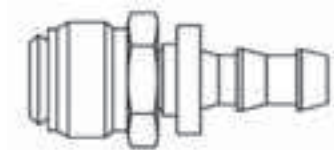

Part Number	Product Number	SAP Number								
			Hose ID	Thread Size (A)	Hex 1 Wrench Size		Cut-Off (C)		Length (L)	
			in.		in.	mm	in.	mm	in.	mm
PB-SIF-0403	22790-0403	20289544	1/4	3/8-24	1/2	13	0.25	6.4	1.12	28.5
PB-SIF-0404	22790-0404	20283090	1/4	7/16-24	5/8	16	0.23	5.8	1.14	29.0
PB-SIF-0405	22790-0405	20289545	1/4	1/2-20	9/16	14	0.26	6.7	1.18	30.0
PB-SIF-0605	22790-0605	20289546	3/8	1/2-20	5/8	16	0.30	7.6	1.32	33.5
PB-SIF-0606	22790-0606	20282734	3/8	5/8-18	3/4	19	0.32	8.2	1.35	34.3
PB-SIF-0808	22790-0808	20283091	1/2	3/4-18	7/8	22	0.65	16.4	1.73	43.9

SAE 45° Inverted Flare

PB (Push-On Brass) fittings for Insta-Grip™ and FXG
Male



Part Number	Product Number	SAP Number								
			Hose ID	Thread Size (A)	Hex 1 Wrench Size		Cut-Off (C)		Length (L)	
			in.		in.	mm	in.	mm	in.	mm
PB-SIM-0403	22795-0403	20289548	1/4	3/8-24	7/16	11	0.69	17.5	1.56	39.6
PB-SIM-0404	22795-0404	20283085	1/4	7/16-24	7/16	11	0.69	17.5	1.56	39.6
PB-SIM-0405	22795-0405	20283086	1/4	1/2-20	1/2	13	0.75	19.1	1.62	41.2
PB-SIM-0505	22795-0505	20283087	5/16	1/2-20	1/2	13	0.75	19.1	1.62	41.2
PB-SIM-0506	22795-0506	20283088	5/16	5/8-18	5/8	16	0.76	19.3	1.63	41.4
PB-SIM-0605	22795-0605	20282730	3/8	1/2-20	1/2	13	0.75	19.1	1.72	43.7
PB-SIM-0606	22795-0606	20282731	3/8	5/8-18	5/8	16	0.79	20.1	1.76	44.7
PB-SIM-0808	22795-0808	20283089	1/2	3/4-18	3/4	19	0.87	22.1	1.84	46.7
PB-SIM-1010	22795-1010	20289550	5/8	7/8-18	1	25	0.90	22.9	2.35	59.7



Download the **MyCrimp App**
for more information.

Section 10
Specialty Fittings

FITTINGS



SECTION 11 - FERRULES

Fitting Ferrules

This section lists dimensions and attributes for 7 Uni-Crimp™ and 2 Dual-Grip style ferrules.

Uni-Crimp™ Fitting Ferrules

The Uni-Crimp™ style ferrules can be non-skive or external skive, depending on the hose family.

Uni-Crimp™ ferrules are to be used only with Uni-Crimp™ style stems.

Dual-Grip Fitting Ferrules

The Dual-Grip style ferrules are external and internal skive and are to be used only with Dual-Grip style stems.

UC Fittings Overview

A complete overview of all UC fittings found in this section.

Uni-Crimp™ UCF2



UCF2

P. 383

Uni-Crimp™ UCF3



UCF3

P. 383

Uni-Crimp™ UCF6



UCF6

P. 384

Uni-Crimp™ UCF8



UCF8

P. 385

Uni-Crimp™ UCF9



UCF9

P. 385

Uni-Crimp™ UCF10



UCF10

P. 386

Uni-Crimp™ UCF11



UCF11

P. 386

Dual-Grip DGF1



DGF1

P. 387

Dual-Grip DGF2



DGF2

P. 387

Uni-Crimp™ UCF2 Ferrule

Compatible with SR6, HR6, BOP 3000

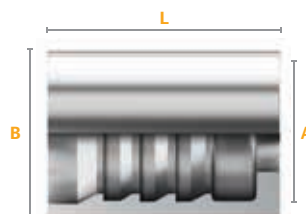

Part Number	SAP Number	Hose ID	Ferrule Inside Diameter (A)		Ferrule Outside Diameter (B)		Ferrule Length (L)	
			in.	mm	in.	mm	in.	mm
UCF2-03	20242268	3/16	0.49	12.5	0.75	19.1	0.94	23.9
UCF2-04	20242276	1/4	0.55	14.0	0.83	21.0	1.04	26.3
UCF2-05	20242272	5/16	0.62	15.7	0.87	22.0	1.04	26.5
UCF2-06	20242273	3/8	0.71	18.1	0.98	25.0	1.12	28.5
UCF2-08	20242270	1/2	0.84	21.4	1.14	29.0	1.37	34.7
UCF2-08S	20575005	1/2	0.84	21.4	1.14	29.0	1.37	34.7
UCF2-10	20242275	5/8	0.98	25.0	1.26	32.0	1.48	37.5
UCF2-12	20242264	3/4	1.13	28.8	1.42	36.0	1.62	41.2
UCF2-16	20242267	1	1.44	36.5	1.77	45.0	1.87	47.6

Uni-Crimp™ UCF3 Ferrule

Compatible with BOP 5000

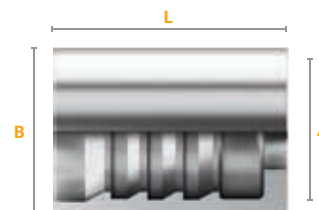

Part Number	SAP Number	Hose ID	Ferrule Inside Diameter (A)		Ferrule Outside Diameter (B)		Ferrule Length (L)	
			in.	mm	in.	mm	in.	mm
UCF3-06	20241235	3/8	0.72	18.4	0.98	25.0	1.12	28.5
UCF3-08	20671286	1/2	0.84	21.4	1.14	29.0	1.37	34.7
UCF3-12	20668542	3/8	1.17	29.8	1.46	37.0	1.64	41.7



Download the **MyCrimp App** for more information.

Section 11

Ferrules

FITTINGS



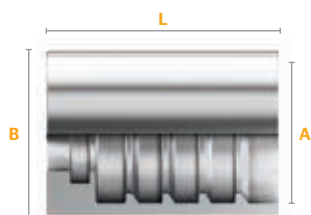

Uni-Crimp™ UCF6 Ferrule

Compatible with

SR1SN, SR2SN, SFS (Hose dash size -03)

SR3, HR4, SR5, DR5 (Hose dash sizes under -32)

Part Number	SAP Number	Hose ID	Ferrule Inside Diameter (A)		Ferrule Outside Diameter (B)		Ferrule Length (L)	
			in.	mm	in.	mm	in.	mm
UCF6-03	20288135	3/16	0.56	14.2	0.79	20.0	0.96	24.3
UCF6-04	20242277	1/4	0.64	16.2	0.84	21.3	1.04	26.3
UCF6-04S	20879832	1/4	0.64	16.2	0.84	21.3	1.04	26.3
UCF6-05	20241236	5/16	0.71	18.0	0.98	25.0	1.04	26.3
UCF6-06	20242282	3/8	0.82	20.9	0.98	25.0	1.07	27.2
UCF6-06S	20873144	3/8	0.82	20.9	0.98	25.0	1.07	27.2
UCF6-08	20242269	1/2	0.96	24.4	1.142	29.0	1.29	32.8
UCF6-08S	20879833	1/2	0.96	24.4	1.142	29.0	1.29	32.8
UCF6-10	20283401	5/8	1.09	27.7	1.339	34.0	1.40	35.6
UCF6-12	20242279	3/4	1.25	31.8	1.49	38.0	1.52	38.6
UCF6-12S	20777819	3/4	1.25	31.8	1.49	38.0	1.52	38.6
UCF6-16	20242280	1	1.65	42.0	1.97	50.0	1.79	45.4
UCF6-16S	20777819	1	1.65	42.0	1.94	49.3	1.79	45.4
UCF6-20	20242278	1¼	1.81	46.0	2.01	51.0	1.93	49.0
UCF6-20S	20676945	1¼	1.81	46.0	2.01	51.0	1.93	49.0
UCF6-24	20242274	1½	2.14	54.3	2.37	60.3	2.21	56.0
UCF6-24S	20873145	1½	2.14	54.3	2.37	60.3	2.21	56.0
UCF6-32	20242271	2	2.72	69.1	2.99	76.1	2.72	69.0
UCF6-32S	20672344	2	2.72	69.1	2.99	76.1	2.72	69.0
UCF6-40	20242263	2½	3.19	81.0	3.50	88.9	3.35	85.0

Uni-Crimp™ UCF8 Ferrule

Compatible with SR5, DR5

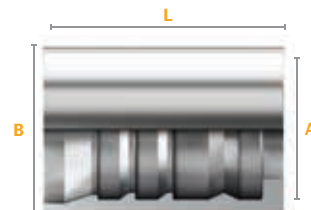

Part Number	SAP Number	Hose ID	Ferrule Inside Diameter (A)		Ferrule Outside Diameter (B)		Ferrule Length (L)	
			in.	mm	in.	mm	in.	mm
UCF8-32	20289652	2	2.41	61.3	2.79	71.0	2.51	63.6

Uni-Crimp™ UCF9 Ferrule

Compatible with SR14A



Part Number	SAP Number	Hose ID	Ferrule Inside Diameter (A)		Ferrule Outside Diameter (B)		Ferrule Length (L)	
			in.	mm	in.	mm	in.	mm
UCF9-03	20318605	3/16	0.39	10.0	0.55	14.0	0.98	24.9
UCF9-04	20303300	1/4	0.43	11.0	0.59	15.0	1.14	29.0
UCF9-04S	20540398	1/4	0.43	11.0	0.59	15.0	1.14	29.0
UCF9-05	20303301	5/16	0.51	13.0	0.67	17.0	1.18	30.0
UCF9-05S	20540399	5/16	0.51	13.0	0.67	17.0	1.18	30.0
UCF9-06	20303302	3/8	0.67	17.0	0.87	22.0	1.22	31.0
UCF9-06S	20540680	3/8	0.67	17.0	0.87	22.0	1.22	31.0
UCF9-08	20303303	1/2	0.79	20.0	0.98	25.0	1.34	34.0
UCF9-08S	20540681	1/2	0.79	20.0	0.98	25.0	1.34	34.0
UCF9-10	20303304	5/8	0.98	25.0	1.18	30.0	1.42	36.0
UCF9-10S	20540682	5/8	0.98	25.0	1.18	30.0	1.42	36.0
UCF9-12	20303305	3/4	1.17	29.8	1.38	35.0	1.58	40.0
UCF9-12S	20540683	3/4	1.17	29.8	1.38	35.0	1.58	40.0
UCF9-16	20303306	1	1.45	36.8	1.65	42.0	1.81	46.0
UCF9-16S	20540684	1	1.45	36.8	1.65	42.0	1.81	46.0



Download the **MyCrimp App** for more information.

Section 11

Ferrules

FITTINGS





Uni-Crimp™ UCF10 Ferrule

Compatible with

SCP3 (Hose dash sizes -08 through -12)

ACP3 (Hose dash size -08)

Part Number	SAP Number	Hose ID	Ferrule Inside Diameter (A)		Ferrule Outside Diameter (B)		Ferrule Length (L)	
			in.	mm	in.	mm	in.	mm
UCF10-04	20646659	1/4	0.49	12.7	0.75	19.0	1.04	26.4
UCF10-08	20357071	1/2	0.82	20.9	1.08	27.5	1.29	32.8
UCF10-10	20676729	5/8	1.03	26.1	1.34	34.0	1.40	35.6
UCF10-12	20676720	3/4	1.19	30.2	1.49	38.0	1.52	38.6
UCF10-16	20675424	1	1.56	39.6	2.01	51.0	1.78	45.2

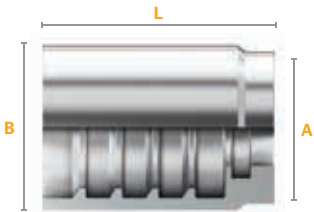

Uni-Crimp™ UCF11 Ferrule

Compatible with SCP3, ACP3

Part Number	SAP Number	Hose ID	Ferrule Inside Diameter (A)		Ferrule Outside Diameter (B)		Ferrule Length (L)	
			in.	mm	in.	mm	in.	mm
UCF11-04	20369170	1/4	0.61	15.4	0.87	22.0	1.04	26.3
UCF11-06	20706519	1/4	0.68	17.3	0.97	24.6	1.18	30.0

Dual-Grip DGF1 Ferrule



Part Number	SAP Number	Hose ID	Ferrule Inside Diameter (A)		Ferrule Outside Diameter (B)		Ferrule Length (L)	
			in.	mm	in.	mm	in.	mm
DGF1-12	20242262	3/4	1.18	30.0	1.46	37.1	2.36	59.9
DGF1-16	20242265	1	1.47	37.3	1.81	46.0	2.93	74.4
DGF1-20	20241238	1 ¼	1.74	44.2	2.17	55.1	3.46	87.9
DGF1-24	20254315	1 ½	2.02	51.3	2.44	62.0	3.70	94.0
DGF1-32	20254316	2	2.60	66.0	3.07	78.0	3.90	99.0

Dual-Grip DGF2 Ferrule

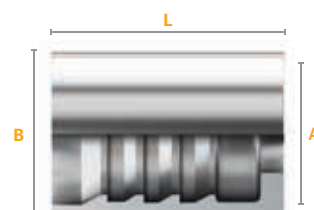

Part Number	SAP Number	Hose ID	Ferrule Inside Diameter (A)		Ferrule Outside Diameter (B)		Ferrule Length (L)	
			in.	mm	in.	mm	in.	mm
DGF2-20	20242260	1 ¼	1.95	49.5	2.43	61.7	3.46	87.9
DGF2-24	20242261	1 ½	2.20	55.9	2.72	69.1	3.70	94.0
DGF2-32	20241239	2	2.80	71.1	3.43	87.1	3.90	99.1

Choosing the Correct Fittings

Choosing the correct fitting may be simplified by identifying the fitting to be replaced by measuring the fitting or in some other way, identifying its size and thread type. Care should be taken in using the correct fitting.

1. The correct fitting is chosen to match a replacement fitting and/or chosen on the basis of formal design and sound engineering practice.
2. Any questions or concerns involving fitting selection should be addressed with the local Sales Representative, Hydraulic Applications Group or with our Customer Service Group at 800-235-4632.
3. Selecting the proper hose assembly - see assemblies section of this catalog. A helpful guide is the "S.T.A.M.P.E.D." process, which requires the documentation of the following:

S Size	ID, OD and length of the assembly
T Temperature	Temperature of material conveyed and climatic conditions
A Application	Conditions of use including abrasion, flexing and routing
M Material	Type, concentration and composition
P Pressure	Includes surge or impulse pressure
E Ends	Style, type, orientation and attachment methods
D Delivery	Includes testing, quality and packaging requirements

In completing the "S.T.A.M.P.E.D." process, "Ends" need to be further defined:

Thread Size	Drop Length
Thread Type	Hose Type
Male or Female	Hose Dash Size
Angle or Elbow	Hose Working Pressure

4. The fitting is available in four styles including Ultra-Crimp™, Uni-Crimp™, Field-Grip™ or Dual-Grip. Each fitting consists of a stem and a ferrule. The stem fits into the Hose ID. The ferrule attaches the fitting to the hose cover. The stem has two functional ends. The first is the hose end, which is used to attach the fitting to the hose. The hose end must be compatible with the ID of the hose. The other end is the thread end, which is used to attach the assembly to another port in the hydraulic system. The thread end will be determined from the fitting being replaced or by measuring the port or threads being attached.
5. Temperature range is important in both hose and fitting selection. Hose temperature limits are shown on page 121 of this catalog. In general, fittings will be comparable with hose temperature ranges with the exception of O-Ring fittings, which are limited to 212°F (100°C).
6. Flange identification requires additional information. Code 61 Flanges, Code 62 Flanges and Caterpillar® Flanges are commonly used to connect large sizes of hose and tubing. Code 61 Flanges are commonly used in applications of 3,000-5,000 psi working pressure, while Code 62 Flanges can be used in applications up to 6,000 psi working pressure. Code 62 and Caterpillar® Flanges are similar in application but Caterpillar® Flanges have a thicker flange head and are frequently found on Caterpillar® equipment. Flanges are identified by measuring the port hole diameter, the longest bolt hole spacing and the flange head thickness.
7. It is possible to have a fitting rated at a lower working pressure than the hose. Keep working pressure in mind when selecting a fitting. The hose assembly can be rated no greater than the lowest pressure rating of either hose or fitting. Reference working pressure tables can be found on pages 112-117.

Note: Dimensions in the catalog are listed as approximate and for reference only. Dimensions are subject to change.

Fittings Working Pressure Guide

Maximum Recommended Working Pressure (psi)

Choose fittings carefully, considering the working pressure of both hose and fitting. The maximum working pressure of the hose assembly is the lesser of the rated working pressure of the hose and the fitting.

Working pressures shown on the page are not applicable for the Field Grip™ reattachable fittings (FG-*). Please contact Continental Customer Service for the working pressure of the FG fittings.

Fitting Style	Thread Dash Size											
	-02	-04	-05	-06	-08	-10	-12	-14	-16	-20	-24	-32
JIC 37° Flare Male Non-Swivel	6000	6000	6000	6000	5000	4000	4000		4000	3000	3000	3000
JIC 37° Flare Female Swivel	6000	6000	6000	6000	5000	4000	4000		4000	3000	3000	3000
NPTF Male Swivel	6000		6000	6000	5000		2250		2000			
NPTF Male Non-Swivel	6000		6000	6000	5000		4000		4000	3000	2500	2500
NPTF Female Swivel	6000		6000	6000	5000		2250		2000	1625		
NPSM Female Swivel	6000		6000	6000	5000		2250		2000	1625		
Code 61 Flange					5000	5000	5000		5000	4000	3000	3000
Code 62 Flange					6000	6000	6000		6000	6000	6000	6000
CAT® Flange							6000		6000	6000	6000	6000
Straight Thread O-Ring Boss Male	5000	5000	5000	5000	4500	4000	4000		4000	3000		
O-Ring Face Seal Female	6000		6000	6000	6000	6000	6000		6000	4000	4000	
SAE 45 Flare Female Swivel	3000		3000	3000	3000	2750	2250		2000	1625	1250	1125
SAE J514 Flareless Tube	5000	5000	4000	3500	3500	2750	2250		2000	1625		
BSPP O-Ring Female Swivel	5800		5800	5800	5000	5000	4500		3500	2850	2250	1800
BSPT Male Non-Swivel	5800		5800	5800	5000	5000	4500		3500	2850	2250	1800
BSPP Male Non-Swivel	5800		5800	5800	5000	5000	4500		3500	2850	2250	1800
DIN 24° Light Female Swivel	3625	3625	3625	3625	3625	3625	2320		2320	1450	1450	1450
DIN 24° Light Male	3625	3625	3625	3625	3625	3625	2320		2320	1450	1450	1450
DIN 24° Heavy Female Swivel		5800	5800	5800	5800	5800	5800		5800	5800	3625	3625
DIN 24° Heavy Male		5800	5800	5800	5800	5800	5800		5800	5800	3625	3625
JIS 30° Flare Female Swivel	5000		5000	5000	5000		4000		3000	2500	1500	1500
JIS 30° Flareless Female Swivel	5000		5000	5000	5000		4000		3000	2500	1500	1500
Komatsu® 30° Female Swivel (Metric Threads)	5000		5000	5000	5000		4000		3000	2500	1500	1500

Selection of the proper Continental Brand fitting is essential to the proper operation and safe use of the hose assembly and related equipment. Inadequate attention to the selection of the proper fitting for the application can result in failure of the fitting which can cause serious bodily injury or property damage from spraying fluids or projectiles.

Thread Reference Chart

Fitting Style	Thread Type												
	02	03	04	05	06	08	10	12	14	15	16	18	20
JIC 37° Flare (SAE J514)		$\frac{3}{8}$ - 24	$\frac{7}{16}$ - 20	$\frac{1}{2}$ - 20	$\frac{9}{16}$ - 18	$\frac{3}{4}$ - 16	$\frac{7}{8}$ - 14	$1\frac{1}{16}$ - 12	$1\frac{3}{16}$ - 12		$1\frac{5}{16}$ - 12		$1\frac{5}{8}$ - 12
SAE 45° J512 Flare			$\frac{7}{16}$ - 20	$\frac{1}{2}$ - 20	$\frac{9}{16}$ - 18	$\frac{3}{4}$ - 16	$\frac{7}{8}$ - 14	$1\frac{1}{16}$ - 14					
SAE 45° Inverted Flare		$\frac{3}{8}$ - 24	$\frac{7}{16}$ - 24	$\frac{1}{2}$ - 20	$\frac{9}{16}$ - 18	$\frac{3}{4}$ - 18	$\frac{7}{8}$ - 18						
NPTF	$\frac{1}{8}$ - 27		$\frac{1}{4}$ - 18		$\frac{3}{8}$ - 18	$\frac{1}{2}$ - 14		$\frac{3}{4}$ - 14			$1-11\frac{1}{2}$		$1\frac{1}{4}-11\frac{1}{2}$
NPSM			$\frac{1}{4}$ - 18		$\frac{3}{8}$ - 18	$\frac{1}{2}$ - 14		$\frac{3}{4}$ - 14			$1-11\frac{1}{2}$		$1\frac{1}{4}-11\frac{1}{2}$
NPM API											$1-11\frac{1}{2}$		$1\frac{1}{4}-11\frac{1}{2}$
SAE J514 Flareless Tube			$\frac{7}{16}$ - 20	$\frac{1}{2}$ - 20	$\frac{9}{16}$ - 18	$\frac{3}{4}$ - 16	$\frac{7}{8}$ - 14	$1\frac{1}{16}$ - 12			$1\frac{5}{16}$ - 12		
O-Ring Face Seal (SAE J1453 ORS/ORFS)			$\frac{9}{16}$ - 18		$1\frac{1}{16}$ - 16	$1\frac{3}{16}$ - 16	$1-14$	$1\frac{3}{16}$ - 12			$1\frac{5}{16}$ - 12		$1\frac{11}{16}$ - 12
O-Ring Boss Straight Thread (SAE J514)			$\frac{7}{16}$ - 20	$\frac{1}{2}$ - 20	$\frac{9}{16}$ - 18	$\frac{3}{4}$ - 16	$\frac{7}{8}$ - 14	$1\frac{1}{16}$ - 12			$1\frac{5}{16}$ - 12		$1\frac{5}{8}$ - 12
BSPP (British Standard Pipe Parallel)			$\frac{1}{4}$ - 19		$\frac{3}{8}$ - 19	$\frac{1}{2}$ - 14	$\frac{5}{8}$ - 14	$\frac{3}{4}$ - 14			$1-11$		$1\frac{1}{4}-11$
BSPT (British Standard Pipe Tapered)			$\frac{1}{4}$ - 19		$\frac{3}{8}$ - 19	$\frac{1}{2}$ - 14		$\frac{3}{4}$ - 14			$1-11$		
BSP Flat Seat (British Standard Pipe)					$\frac{3}{8}$ - 19	$\frac{1}{2}$ - 14		$\frac{3}{4}$ - 14					
JIS 30° (Parallel Pipe Threads)			$\frac{1}{4}$ - 19		$\frac{3}{8}$ - 19	$\frac{1}{2}$ - 14		$\frac{3}{4}$ - 14			$1-11$		$1\frac{1}{4}-11$
Code 61 Flange (SAE J518) - Dia.						1.19		1.5			1.75		2
Code 62 Flange (SAE J518) - Dia.						1.25		1.63			1.87		2.13
Caterpillar® Flange - Dia.								1.63			1.87		2.13
Komatsu® Flange - Dia.								1.34					
Standpipe - OD						8 mm	10 mm	12 mm		15 mm	16 mm	18 mm	20 mm
DIN 24° Light								$12 \times 1\frac{1}{2}$	$14 \times 1\frac{1}{2}$		$16 \times 1\frac{1}{2}$	$18 \times 1\frac{1}{2}$	
DIN 24° Heavy											$16 \times 1\frac{1}{2}$	$18 \times 1\frac{1}{2}$	$20 \times 1\frac{1}{2}$
DIN 60°								$14 \times 1\frac{1}{2}$		$16 \times 1\frac{1}{2}$	$18 \times 1\frac{1}{2}$		
Komatsu® 30° Flare (Metric Threads)								$14 \times 1\frac{1}{2}$			$18 \times 1\frac{1}{2}$		

All measurements in inches unless otherwise noted.

Fitting Style	Thread Type												
	22	24	26	28	30	32	33	36	40	42	45	52	
JIC 37° Flare (SAE J514)	1½ - 12			2½ - 12									
SAE 45° J512 Flare													
SAE 45° Inverted Flare													
NPTF	1½ - 11½			2 - 11½									
NPSM													
NPM API	1½ - 11½			2 - 11½									
SAE J514 Flareless Tube													
O-Ring Face Seal (SAE J1453 ORS/ORFS)	2-12												
O-Ring Boss Straight Thread (SAE J514)	1 7/8 - 12												
BSPP (British Standard Pipe Parallel)	1½ - 11			2-11									
BSPT (British Standard Pipe Tapered)													
BSP Flat Seat (British Standard Pipe)													
JIS 30° (Parallel Pipe Threads)													
Code 61 Flange (SAE J518) - Dia.	2.37			2.81			3.31						
Code 62 Flange (SAE J518) - Dia.	2.5			3.13									
Caterpillar® Flange - Dia.	2.5												
Komatsu® Flange - Dia.													
Standpipe - OD	22 mm			28 mm									
DIN 24° Light	22 x 1½		26 x 1½		30 x 2			36 x 2			45 x 2		
DIN 24° Heavy	22 x 1½		24 x 1½		30 x 2			36 x 2			42 x 2		52 x 2
DIN 60°	22 x 1½		26 x 1½										
Komatsu® 30° Flare (Metric Threads)	22 x 1½		24 x 1½		30 x 1½			33 x 1.5		36 x 1½			

All measurements in inches unless otherwise noted.

Fitting Accessories: O-Rings



Material	NBR
Hardness	90 Shore A
Temperature Range	-25°C to 125°C (-13°F to 257°F)

BSPB (British Standard Pipe Parallel) O-Rings

Descriptive Number	Product Number	SAP Number	ID	Width	Thread Dash Size
			in.	in.	
OBSPP-04	60505-0004	20245720	0.256	0.039	-04
OBSPP-06	60505-0006	20245723	0.319	0.063	-06
OBSPP-08	60505-0008	20245539	0.476	0.063	-08
OBSPP-10	60505-0010	20245724	0.516	0.063	-10
OBSPP-12	60505-0012	20245722	0.673	0.063	-12
OBSPP-16	60505-0016	20245536	0.870	0.063	-16
OBSPP-20	60505-0020	20245538	1.146	0.063	-20
OBSPP-24	60505-0024	20245537	1.382	0.063	-24
OBSPP-32	60505-0032	20245721	1.890	0.059	-32

DIN 24 Light O-Rings

Descriptive Number	Product Number	SAP Number	ID	Width	Thread Dash Size
			in.	in.	
ODIN24L-14	60520-0014	20245731	0.236	0.059	-14
ODIN24L-16	60520-0016	20245732	0.295	0.059	-16
ODIN4L-18	60520-0018	20245733	0.354	0.059	-18
ODIN4L-22	60520-0022	20245734	0.472	0.079	-22
ODIN4L-26	60520-0026	20245735	0.591	0.079	-26
ODIN4L-30	60520-0030	20245736	0.787	0.079	-30
ODIN4L-36	60520-0036	20245737	1.024	0.079	-36
ODIN4L-45	60520-0045	20245738	1.260	0.098	-45
ODIN24L-52	60520-0052	20245739	1.496	0.098	-52

DIN 24 Heavy O-Rings

Descriptive Number	Product Number	SAP Number	ID	Width	Thread Dash Size
			in.	in.	
ODIN24H-22	60515-0022	20245740	0.394	0.079	-22
ODIN24H-30	60515-0030	20245741	0.642	0.094	-30
ODIN24H-36	60515-0036	20245742	0.799	0.094	-36
ODIN24H-42	60515-0042	20245743	0.984	0.098	-42
ODIN24H-52	60515-0052	20245744	1.311	0.094	-52

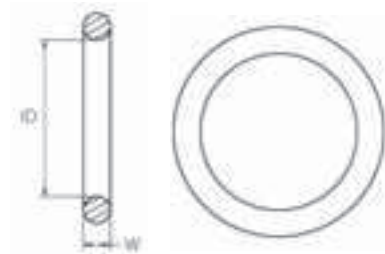

Material NBR
 Hardness 90 Shore A
 Temperature Range -25 °C to 125 °C
 (-13 °F to 257 °F)

O-Ring Face Seal O-Rings (SAE J1453 ORS/ORFS)

Descriptive Number	Product Number	SAP Number	ID	Width	Thread Dash Size
			in.	in.	
OORFS-04	60525-0004	20245751	0.301	0.07	-04
OORFS-06	60525-0006	20245749	0.364	0.07	-06
OORFS-08	60525-0008	20245750	0.488	0.07	-08
OORFS-10	60525-0010	20245746	0.614	0.07	-10
OORFS-12	60525-0012	20245747	0.739	0.07	-12
OORFS-16	60525-0016	20245748	0.926	0.07	-16
OORFS-20	60525-0020	20245745	1.176	0.07	-20
OORFS-24	60525-0024	20431832	1.489	0.07	-24

O-Ring Boss Straight Thread O-Rings (SAE J514)

Descriptive Number	Product Number	SAP Number	ID	Width	Thread Dash Size
			in.	in.	
ORB-02	60530-0002	20431833	0.239	0.062	-02
ORB-04	60530-0004	20245756	0.351	0.072	-04
ORB-05	60530-0005	20245754	0.414	0.072	-05
ORB-06	60530-0006	20245758	0.468	0.078	-06
ORB-08	60530-0008	20245755	0.644	0.087	-08
ORB-10	60530-0010	20245757	0.755	0.097	-10
ORB-12	60530-0012	20245752	0.924	0.116	-12
ORB-16	60530-0016	20245753	1.171	0.116	-16
ORB-20	60530-0020	20431834	1.475	0.119	-20
ORB-24	60530-0024	20431835	1.720	0.119	-24
ORB-32	60530-0032	20431836	2.337	0.120	-32

Caterpillar® Flange O-Rings Code 61 and Code 62 Flange O-Rings (SAE J518)

Descriptive Number	Product Number	SAP Number	ID	Width	Thread Dash Size
			in.	in.	
O6162-08	60500-0008	20245728	0.734	0.139	-08
O6162-10	60500-0010	20431831	0.859	0.139	-10
O6162-12	60500-0012	20245730	0.984	0.139	-12
O6162-16	60500-0016	20245727	1.296	0.139	-16
O6162-20	60500-0020	20245726	1.484	0.139	-20
O6162-24	60500-0024	20245725	1.859	0.139	-24
O6162-32	60500-0032	20245729	2.234	0.139	-32
O6162-40	60500-0040	20246508	2.734	0.139	-40

Split Flanges, Code 61 and 62 (SAE J518)

Flanges are commonly used to connect large sizes of hose and tubing. An O-Ring in the flange head seals on a smooth face, female port. The male flange head and female port are held in place with two clamp halves and four bolts. Flanges conform to SAE J518 standard and are identified as Code 61 or the “standard series” and Code 62 or “high-pressure series.” The two flanges are not interchangeable as Code 61 is used in applications of up to 5,000 psi working pressure. Code 62 is designed for 6,000 psi working pressure. Code 61 and Code 62 are dimensionally different. Specifics on Code 61 and Code 62 flanges are found in the following charts.

Determine Flange Size

Method 1: Measure the port hole inside diameter (ID)

Method 2: Measure the “A” dimension on the flange, which is the longest bolt hole spacing from center-to-center.

Assembly Procedure

1. Clean all mating services.
2. Replace O-Ring. Lubricate before installation.
3. Partially tighten each bolt in rotation until all are fully tightened to the recommended torque value listed in the appendix.

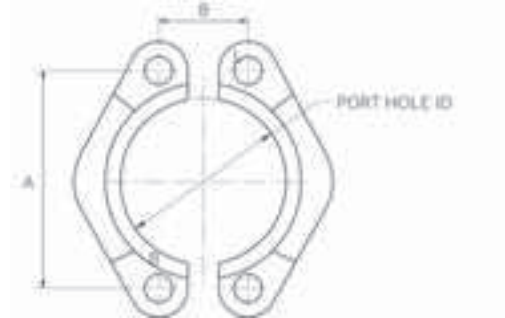

Code 61 Split Flange Clamp Kits

Includes Clamp Halves, 4 Bolts, 4 Lockwashes and 1 O-Ring

Descriptive Number	Product Number	SAP Number	Port Hole ID	A	B	Maximum Working Pressure	Recommended Grade 8 Bolts
			in.	in.	in.	psi	
FL61SC-08	60061-0008	20246512	1/2	1.500	0.685	5000	5/16 - 18 x 1 1/4
FL61SC-12	60061-0012	20246513	3/4	1.874	0.874	5000	3/8 - 16 x 1 1/2
FL61SC-16	60061-0016	20246514	1	2.063	1.031	5000	3/8 - 16 x 1 1/4
FL61SC-20	60061-0020	20246515	1 1/4	2.311	1.189	4000	7/16 - 14 x 1 1/2
FL61SC-24	60061-0024	20246516	1 1/2	2.752	1.409	3000	1/2 - 13 x 1 1/2
FL61SC-32	60061-0032	20246517	2	3.063	1.685	3000	1/2 - 13 x 1 3/4
FL61SC-40	60061-0040	20246467	2 1/2	3.504	2.008	2500	1/2 - 13 x 1 3/4

Code 62 Split Flange Clamp Kits

Includes Clamp Halves, 4 Bolts, 4 Lockwashes and 1 O-Ring

Descriptive Number	Product Number	SAP Number	Port Hole ID	A	B	Maximum Working Pressure	Recommended Grade 8 Bolts
			in.	in.	in.	psi	
FL2SC-08	60062-0008	20246519	1/2	1.594	0.717	6000	5/16 - 18 x 1 1/4
FL2SC-12	60062-0012	20246520	3/4	2.000	0.937	6000	3/8 - 16 x 1 1/2
FL2SC-16	60062-0016	20246521	1	2.252	1.094	6000	7/16 - 14 x 1 1/4
FL2SC-20	60062-0020	20246522	1 1/4	2.626	1.252	6000	1/2 - 13 x 1 3/4
FL2SC-24	60062-0024	20246523	1 1/2	3.126	1.441	6000	5/8 - 11 x 2 1/4
FL2SC-32	60062-0032	20246524	2	3.811	1.748	6000	3/4 - 10 x 2 3/4

German Metric Thread ID Template

Ideal for counter and field identification of German Metric DIN threads

(GBS Collateral Item #70086290575800)

Instructions

Female Threads

1. Use the 12° or 30° angle, as shown in the image to the right, to verify that the seat is 12° or 30° (See note).
2. Use the step gauge to determine inside diameter (ID) of female port.
3. Measure Tube OD with the Tube Inside Diameter Gauge.
4. Use Thread ID Table: DIN 2353 along with measured Tube OD to determine if tube is "Heavy" or "Light" Series.

Male Threads

1. Use the 12° or 30° angle, as shown in the image to the right, to verify that the seat is 12° or 30° (See note).
2. Use Fitting Inside Diameter Gauge to measure Inside Threads.
3. Refer to Thread ID Table: DIN 3863 along with measured Thread OD to determine Metric Male Thread. Rule of thumb: On Male Thread, measure the ID of the machined surface and subtract 1 mm to achieve tube OD. For example, when measuring a heavy-duty series Male on an M14 x 1 1/2 thread, the caliper will measure 7 mm (7 mm - 1 mm = 6 mm).

Note: If measured angle is not 12° or 30° use the Fitting Identification Section in the Appendix to identify.

Inclusive angle is the entire angle contained in the machined surface. Each side of the surface measures 1/2 of the total angle (e.g. 24° x 0.5 = 12°).

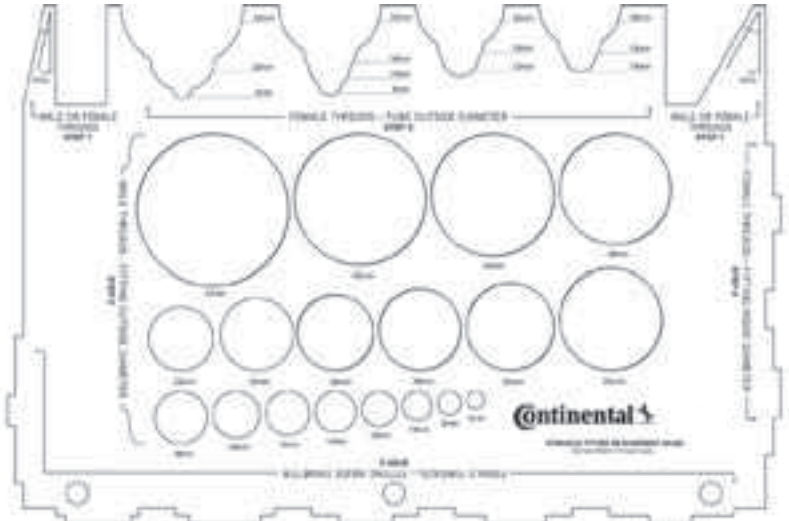

German Metric Thread Types

Female Threads—STEP 4
Thread Identification Table: DIN 2353 24° Cone

Metric Thread (Dia x Pitch)	Female Thread ID mm	Male Thread OD mm	Light Series	Tube OD Heavy Series
M 12 x 1,5	10,5	12	6	8
M 14 x 1,5	12,5	14	8	10
M 16 x 1,5	14,5	16	10	12
M 18 x 1,5	16,5	18	12	14
M 20 x 1,5	18,5	20	15	17
M 22 x 1,5	20,5	22	18	20
M 24 x 1,5	22,5	24	21	23
M 26 x 1,5	24,5	26	24	26
M 30 x 2,0	28,5	30	28	30
M 36 x 2,0	33,9	36	34	38
M 42 x 2,0	39,9	42	40	44
M 45 x 2,0	42,9	45	43	46
M 52 x 2,0	49,9	52	48	54

Male Threads—STEP 3
Thread Identification Table: DIN 3863 60° Cone

Metric Thread (Dia x Pitch)	Female Thread ID mm	Male Thread OD mm	Tube OD 60° Cone mm
M 12 x 1,5	10,5	12	6
M 14 x 1,5	12,5	14	8
M 16 x 1,5	14,5	16	10
M 18 x 1,5	16,5	18	12
M 22 x 1,5	20,5	22	15
M 26 x 1,5	24,5	26	18
M 30 x 2,0	28,5	30	22
M 38 x 2,0	36,5	38	28
M 45 x 2,0	43,5	45	35
M 52 x 2,0	50,5	52	42

Instructions

Female Threads

1. Use the 12° or 30° angle, as shown in the image to the left, to verify that the seat is 12° or 30° (See note).
2. Use the step gauge to determine Inside Diameter of female port.
3. Measure Tube OD with the Tube Outside Diameter Gauge.
4. Use Thread ID Table: DIN 2353 along with measured Tube OD to determine if Tube is "Heavy" or "Light" Series.

Male Threads

1. Use the 12° or 30° angle, as shown in the image to the right, to verify that the seat is 12° or 30° (See note).
2. Use Fitting Inside Diameter Gauge to measure Outside Threads.
3. Refer to Thread ID Table: DIN 3863 along with measured Thread OD to determine Metric Male Thread. Rule of thumb: On Male Thread, measure the ID of the machined surface and subtract 1mm to achieve tube OD. For example, when measuring a heavy-duty series Male on a M14 x 1,5 thread, the caliper will measure 7mm (7mm - 1mm = 6mm).

Note: If measured angle is not 12° or 30°, use the Fitting Identification Section in our Hydraulic Hose Catalog Appendix to identify.

Inclusive Angle is the entire angle contained in the machined surface. Each side of the surface measures 1/2 of the total angle (e.g. 24° x 0.5 = 12°).

Code 61, Code 62, CAT® Flange ID Template

Ideal for counter and field identification of SAE Flanges

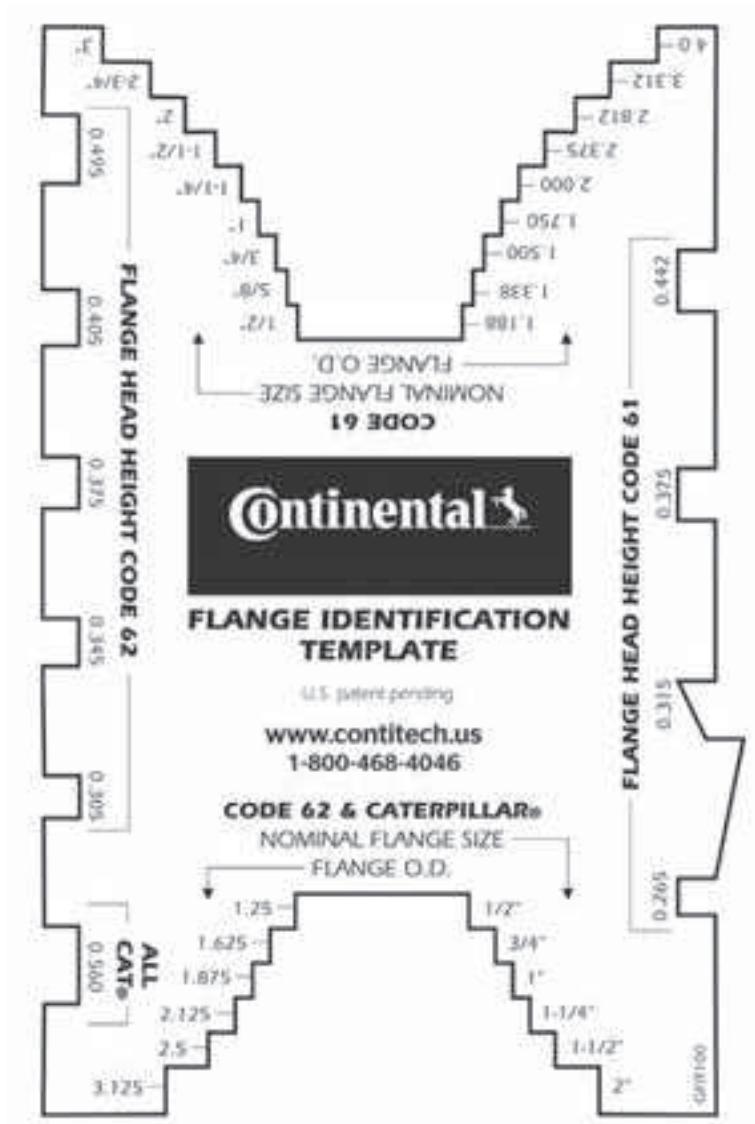

Product #: GFIT100

SAP #: 20243407

Weight: 1.4 oz.

Dimensions: 4 $\frac{1}{8}$ " W x 7 $\frac{1}{8}$ " H

Notes

1. Reverse side of template shows dimensional chart for Code 61/Code 62/CAT® flanges.
2. Above not to scale.
3. As a connection on pumps and motors, the SAE Code 61 and Code 62 4-bolt flanges are used worldwide with three exceptions:
 - a. Although a common size outside of North America, the #10 size is not an SAE standard size.
 - b. Although Caterpillar® flanges have the same OD as SAE Code 62, they have a thicker flange head.
 - c. Porcelain flanges are completely different from SAE flanges.

FITTINGS



Flange ID Template

Code 61 / Code 62 / CAT®

Thread Identification Kit

There are many types of North American threads, as well as British, German, French and Japanese threads. With all the thread types and styles available, it is important to properly identify a fitting so that an assembly can be connected correctly within the hydraulic system. This kit and the tools inside will help you identify a broad selection of different thread types.

The Thread Identification Kit includes:

- › Fitting Identification Manual
- › North American (NA) Thread Pitch Gauge
- › International (INT) Thread Pitch Gauge
- › Seat Angle Gauges 12°, 30°, 37°, 45°
- › ID/OD 3.5" Calipers

Part Number: Fitting ID Pocket Guide

Dimensions: 4 ½" W x 5 ½" H



Steps to Identify a Fitting

1. Select country of origin for the fitting. Use part number if available to determine thread type.
2. Identify the fitting visually using the illustrations in the proper section of the Continental Hydraulic Hose and Fittings Catalog or the Hydraulic Fitting Identification Manual included with the identification kit.
3. Measure the inside diameter or the outside diameter of the fitting threads using the ID/OD Calipers.
4. Measure thread pitch using the North American or International Thread Pitch Gauge. The gauge will determine number of threads per inch or the distance between threads of a metric connection.



5. Measure the angle of the fitting's sealing surface using the Seat Angle Gauge.



6. Compare measurements above to the tables in the fitting catalog or identification manual to complete the identification of the fitting.

Standard and Notched Calipers

Continental calipers help you get the job done.

FEATURES

- › Large LCD display for easy reading
- › 1.5V battery (included)
- › Lockable slider
- › Quick interchangeable readout in inch or metric units for readability
- › 4-way measurement capability for multiple applications: outside diameter (OD), inside diameter (ID), depth and step

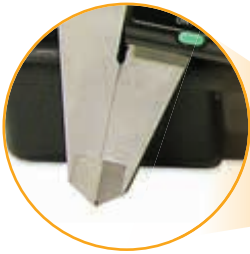

Standard Digital Caliper (Part # 20926932)

- › Long, smooth surface is great for larger crimp flats



Standard Notched Caliper (Part # 20926931)

- › Great for measuring small crimp flats
- › Ideal for measuring AC style crimps

EQUIPMENT & ACCESSORIES



PC125M

Carried to the jobsite with a handle and support stand, the PC125M is ideal for portable crimping requirements. Whether carried on-site, used in a vehicle or even stationary at the shop, the PC125M is designed as a low-volume crimper for occasional use. The crimp diameter is set and controlled with an easy-to-read micrometer. This affordable crimper is packaged in component parts to fit the needs of the user. The PC125M has three power options. No electrical power source is required if using the hand or pneumatic pump option. A 1/2-HP, 110V electric pump is available as well. The PC125M includes die ring pusher, stand, compression ring, pressure plate and a metric micrometer. Pumps and dies are purchased separately.

FEATURES

- › Easy-to-read, fully adjustable metric micrometer allows precise setting of crimp diameters to an accuracy of +/- .1 mm
- › Open design with vertical feed for good operator visibility
- › Removable pusher and spring-loaded die set for easy loading
- › 60-ton cylinder
- › Two-piece, "slide in" die design for easy installation
- › Lightweight for portable field use
- › Color-coded die sets to speed die selection and set up
- › Attach hand, air or electric pump

CAPABILITY

- › 1/4" through 1 1/4" ID, 2-braid hose and 1 1/4" ID 4-spiral hose with all coupling end styles, including most bent tubes

POWER OPTIONS

Part #	Description
20244931	Two-stage hand pump
20244932	Air/hydraulic pump
20244916	1/2-HP, 110V electric pump

OIL CAPACITY 1 gal.

MOUNTING Drawer included

DIMENSIONS 14"L x 11"W x 23 1/2"H

WEIGHT 45 lbs.



PC125M with indicator light

PC125 / PC125M DIES

Part #	Description	Color	ID
20244896	PC125-8.5MM	Black	8.5 mm
20244897	PC125-12MM	Black	12 mm
20244898	PC125-14MM	Red	14 mm
20244899	PC125-16MM	Blue	16 mm
20244920	PC125-19MM	Green	19 mm
20244921	PC125-23MM	Yellow	23 mm
20244922	PC125-27MM	Brown	27 mm
20244923	PC125-31MM	Silver	31 mm
20244924	PC125-34MM	Purple	34 mm
20244925	PC125-41MM	Orange	41 mm
20867524	PC125-43MM	Black	43 mm
20244927	PC125-50MM	Black	50 mm

OPTIONS

- › **PC125M-SKIT (20244937)** Includes the PC125M crimper and 7 die sets (16 mm, 19 mm, 23 mm, 27 mm, 31 mm, 34 mm and 41 mm dies for 1/4" to 1" 1-braid and 2-braid hose)
- › RCDs are also available

CALIPERS

All crimpers include a Continental caliper



Standard
SAP 20926931
Ships with crimper



Notched
SAP 20926931

REPLACEMENT PARTS

Part #	Description	Crimper
20348434	Die ring pusher with magnets	PC125
20551881	Die ring pusher without magnets	PC125M
20395217	Pressure plate	PC125, PC125M
20348513	Notched compression ring	PC125, PC 125M
20244945	Start/stop switch	For 1-HP Pump
20244936	Adjustable coupling stop	PC125
20370792	White breaker switch	PC125, PC150
20370791	Metric micrometer	PC125, PC125M
20370790	Red limit switch	PC125, PC150
20291768	Retaining ring	PC125, PC125M Pusher
9847K13	Vent plug	PC125
104679	Die removal magnet	PC125, PC125M
20708983	CRIMPX die lubricant oil	PC125, PC125M



Notched Pressure Plate
Included



Pressure Plate
Included



Removable Pusher
Included
PC125 with Magnets
PC125M without Magnets

Coupling Stop
Included



CRIMPX Die Lubricant Oil,
4 oz. bottle with dauber cap
Included



Die Removal Magnet
Included



Vent Plug
Included



T420 Metric Micrometer
Included



Pneumatic Pendant Switch
Included



PC125 Drawer
Included only with PC125-SKIT series crimpers



PC125 Die Set



ValPower® Hand Pump, 10,000 psi
Optional



ValPower® Pneumatic Pump, 10,000 psi
Optional



ValPower® Electric Pump
Optional

For additional accessories and replacement parts, please reference the Crimper Operator's Manual.

EQUIPMENT & ACCESSORIES



PC125RCD

The PC125RCD portable crimper, with its open design, removable pusher and easy-to-use, rubber-cage die set, is designed for higher production volume and repetitive use. Crimp diameter is set and controlled with an easy-to-read micrometer. The PC125RCD is packaged for shop service and includes the crimper and 1-HP, 110V electric pump on a common base, pressure plate, magnetized die ring pusher, stop/start remote pendant switch, metric micrometer, adjustable coupling stop and adjustable retraction stop.

FEATURES

- › Easy-to-read, fully adjustable metric micrometer allows precise setting of crimp diameters to an accuracy of +/- .1 mm
- › Open design with vertical feed for good operator visibility
- › Removable pusher and rubber-cage die set for easy loading
- › 60-ton cylinder
- › Automatic shut-off for precise crimps
- › Adjustable retraction stop limits ram retractions for quick repetitive crimps
- › Adjustable coupling stop for accurate, repetitive positioning of the assembly inside the dies
- › Two-piece, rubber-cage die design for easy installation and low maintenance
- › Common base for bench mounting
- › Color-coded die sets to speed die selection and set up
- › 1-HP, 110V AC pump
- › Pneumatic activation (no electric wires) of remote pendant switch

CAPABILITY

- › 1/4" through 1 1/4" ID, 2-braid hose and 1 1/4" ID 4-spiral hose with all coupling end styles, including most bent tubes

POWER OPTIONS

- › 1-HP, 110V AC single phase 50-60 Hz electric pump, with pneumatic stop/start pendant switch (PC125RCD/150-E1 pump)

OIL CAPACITY

1 gal.

MOUNTING

Crimper and pump installed on plate

DIMENSIONS

20"L x 11"W x 19"H

WEIGHT

125 lbs.



PC125RCD
Crimper Series



PC125MRCD
Crimper Series

PC125RCD DIES

Part #	Description	Color	ID
20809576	PC125RCD-16MM	Blue	16 mm
20809577	PC125RCD-19MM	Green	19 mm
20809578	PC125RCD-23MM	Yellow	23 mm
20809579	PC125RCD-27MM	Brown	27 mm
20809760	PC125RCD-31MM	Silver	31 mm
20809761	PC125RCD-34MM	Purple	34 mm
20809762	PC125RCD-41MM	Orange	41 mm
20899115	PC125RCD-43MM	Red	43 mm
20833014	PC125RCD-50MM	Black	50 mm

OPTIONS

› **PC125RCD SKIT** includes the PC125RCD crimper and 8 die sets (16 mm, 19 mm, 23 mm, 27 mm, 31 mm, 34 mm, 41 mm and 50 mm dies) for 1/4" to 1 1/4" 1-braid, 2-braid and 4-spiral hose

SKIT #	Item	Description
20809573	PC125RCD SKIT	Series Crimper, 60 ton
20809574	PC125RCD SKIT (Canada)	Series Crimper, 60 ton
20831205	PC125MRCD SKIT	8 dies (16-50 mm), Select Pump
20969061	PC125RCD SKIT	8 dies (16-50 mm), 2-HP

CALIPERS

All crimpers include a Continental caliper.



Standard
SAP 20926931
Ships with crimper



Notched
SAP 20926931

REPLACEMENT PARTS

Part #	Description	Crimper
20551881	Die ring pusher	PC125RCD, PC125MRCD
103270	Pressure plate	PC125RCD, PC125MRCD
104662	Notched pressure plate	PC125RCD, PC125MRCD
20244945	Start/stop switch	For 1-HP pump
20244936	Adjustable coupling stop	PC125RCD, PC125MRCD
20370792	White breaker switch	PC125RCD/150
103085	T420 micrometer	PC125RCD, PC125MRCD
20370790	Red limit switch	PC125RCD/150
20291768	Retaining ring	PC125RCD, PC125MRCD Pusher
9847K13	Vent plug	PC125RCD
104679	Die removal magnet	PC125RCD, PC125MRCD
20708983	CRIMPX die lubricant oil	PC125RCD, PC125MRCD



Notched Pressure Plate
Included



Pressure Plate
Included



Removable Pusher
Included
PC125 with Magnets
PC125M without Magnets

Coupling Stop
Included



CRIMPX Die
Lubricant Oil,
4 oz. bottle with
dauber cap
Included



Die Removal Magnet
Included



Vent Plug
Included



T420 Metric
Micrometer
Included



Pneumatic
Pendant Switch
Included



PC125 Drawer
*Included only with
PC125-SKIT series crimpers*



PC125RCD Flex Die Sets
and Flex Die Cages
Available



ValPower® Hand
Pump, 10,000 psi
Optional



ValPower® Pneumatic
Pump, 10,000 psi
Optional



ValPower®
Electric Pump
Optional

For additional accessories and replacement parts, please reference the Crimper Operator's Manual.

EQUIPMENT & ACCESSORIES



PC125PS

The PC125PS is a Positive Stop crimper capable of crimping 2-wire braid hose and 4-wire spiral hose up through 1" ID. The crimp diameter is controlled through the use of specific die and spacer combinations. The PC125PS is packaged for shop service and includes the crimper and 1-HP, 110V AC electric pump on a common base, pressure plate, magnetized die pusher, stop/start remote pendant switch, adjustable coupling stop and adjustable retraction stop.

FEATURES

- › Matched die and spacer crimp eliminates need to adjust settings
- › Open design with vertical feed for good operator visibility
- › Removable pusher and rubber-cage die sets for easy loading
- › 60-ton cylinder
- › Adjustable retractor stop limits ram retractions for quick repetitive crimps
- › Adjustable coupling stop for accurate, repetitive positioning of the assembly inside the dies
- › Two-piece, rubber-cage die design for low maintenance
- › Common base for bench mounting
- › Color-coded die sets to speed die selection and set up
- › 1-HP, 110V pump
- › Pneumatic activation of remote pendant switch
- › No adjustable micrometer with this machine; die and ring combination create the adjustment. Limited hose families are compatible only with this machine.

CAPABILITY

- › 1/4" through 1" ID, 2-braid hose and 4-spiral hose

Compatible only with the following hose:
SR1SN, SR2SN, SR/XR/ARC16SC, SCP3, XCP3,
FPII, SR/AR12 and HR4

POWER OPTIONS

- › 1-HP, 110V AC single phase 50-60 Hz electric pump, with pneumatic pendant switch

OIL CAPACITY 1 gal.

MOUNTING Crimper and pump installed on plate

DIMENSIONS 20"L x 11"W x 10"H

WEIGHT 125 lbs.



PC125PS
Crimper Series

PC125PS DIES

Part #	Description	Color	ID
20495490	PSW101-0.650	Blue	0.65 in.
20495491	PSW101-0.785	Green	0.79 in.
20495492	PSW101-0.930	Yellow	0.93 in.
20495494	PSW101-1.120	Brown	1.12 in.
20495495	PSW101-1.260	Silver	1.26 in.
20559205	PSW101-1.410	Purple	1.41 in.
20495496	PSW101-1.610	Black	1.61 in.
20495498	PSW101-1.680	Orange	1.68 in.

OPTIONS

> PC125PS-SKIT includes dies and spacers and die storage unit

SKIT #	Item	Description
20871410	PC125PS SKIT	7 Dies & Spacers
20888687	PC125PS SKIT (Canada)	7 Dies & Spacers

CALIPERS

All crimpers include a Continental caliper.



Standard
SAP 20926931
Ships with crimper



Notched
SAP 20926931

REPLACEMENT PARTS

Part #	Description
20524128	PSW101-0 Spacer
20495500	PSW101-1 Spacer
20495501	PSW101-2 Spacer
20495502	PSW101-3 Spacer
20495503	PSW101-4 Spacer
20495504	PSW101-5 Spacer
20495505	PSW101-6 Spacer
20559204	PSW101-8 Spacer
20902035	PSW101-9 Spacer
20902036	PSW101-10 Spacer
20902037	PSW101-11 Spacer



PC125PS Die Set
Included



Removable Pusher
Included



11 Spacer Rings
Included



Pressure Plate
Included



PC125PS Die Series
Included

For additional accessories and replacement parts, please reference the Crimper Operator's Manual.

EQUIPMENT & ACCESSORIES



PC150H Series

The PC150H offers the ease of use of a horizontal crimper with the power and precise adjustment capabilities usually found in more costly models. With the same crimping capability as the PC150 Series, the “H” model offers hose feed horizontally from either the front or rear through a large 4.9 in. throat opening. The PC150H can be ordered with a 1-HP electric pump (PC150H-1) or a 2-HP electric pump (PC150H-2), producing maximum force in a small package. The PC150H makes repetitive crimps fast and easy to accomplish with a precise, direct-read digital adjustment and a built-in cylinder retraction stop. The PC150H also offers convenience features found in both our vertical and horizontal crimpers including a pneumatic start/stop pendant switch, a magnetic die change tool, an optional die rack for storing dies and master die grease fittings as a special feature for easy lubrication.

FEATURES

- › Easy-to-read micrometer provides precise crimp settings
- › Hose feed is horizontal from both the front and rear
- › Easy die loading with magnetic die change tool
- › Max die size 56 mm
- › 155-ton crimping force
- › Automatic shut-off for precise crimps
- › Retraction stop limits die travel for faster repetitive crimps
- › Large 13-qt. oil reservoir to cool components during repetitive crimps
- › Pneumatic activation using remote pendant switch
- › 1-HP and 2-HP power options

CAPABILITY

- › 1/4" through 1 1/2" ID, 2-braid hose and 4-spiral hose with all coupling styles and most bent tubes

POWER OPTIONS

- › 1-HP, 110V AC, single phase (PC150H-1)
- › 2-HP, 220V AC, single phase (PC150H-2)

OIL CAPACITY 13 qt.

MOUNTING Bench or cabinet

DIMENSIONS 15"L x 23 1/2"W x 20 1/2"H

WEIGHT 245 lbs.



PC150H
Crimper Series

PC150H DIE SETS

Part #	Description	Color
20316414	PC150H 8.5 mm bore x 57 mm long	Black
20316415	PC150H 12 mm bore x 57 mm long	Black
20316416	PC150H 14 mm bore x 50.8 mm long	Red
20316417	PC150H 16 mm bore x 57 mm long	Black
20316418	PC150H 19 mm bore x 57 mm long	Green
20316419	PC150H 23 mm bore x 70 mm long	Yellow
20316420	PC150H 27 mm bore x 63.5 mm long	Brown
20316421	PC150H 31 mm bore x 63.5 mm long	Silver
20316422	PC150H 34 mm bore x 63.5 mm long	Purple
20316423	PC150H 41 mm bore x 76.2 mm long	Orange
20316424	PC150H 45 mm bore x 76.2 mm long	Black
20316425	PC150H 50 mm bore x 76.2 mm long	Black
20316426	PC150H 56 mm bore x 76.2 mm long	Black

OPTIONS

- > **PC150H-1 SKIT** Includes the PC150H-1 crimper and 7 die sets (16 mm, 19 mm, 23 mm, 31 mm, 41 mm, 50 mm and 56 mm)
- > **PC150H-2 SKIT** Includes the PC150H-2 crimper and 7 die sets (16 mm, 19 mm, 23 mm, 31 mm, 41 mm, 50 mm and 56 mm)
- > **PC150H-Rack** Black die cabinet, 7"L x 13"W x 18"H, holds 9 dies

SKIT #	Item	Description
20316359	PC150H SKIT	110-210 V AC, Single Phase, 1-HP
20316440	PC150H SKIT	220-230 V AC, Single Phase, 2-HP
20316441	PC150H SKIT (Canada)	110-210 V AC, Single Phase, 1-HP
20316448	PC150H SKIT (Canada)	220-230 V AC, Single Phase, 2-HP

CALIPERS

All crimpers include a Continental caliper.



Standard
SAP 20926931
Ships with crimper



Notched
SAP 20926931

REPLACEMENT PARTS

Part #	Description	Quantity
20419636	PC150H Protection Pad	8
20319405	PC150H Die Change Tool	1
20244945	PC125/150 Pneumatic Pendant Switch	1
20370792	PC125/150 White Breaker Switch	1

9 Station Die Rack
Included



Die Change Tool
Included



PC150H Die Set
Included

Crimper Features



Retractor Stop

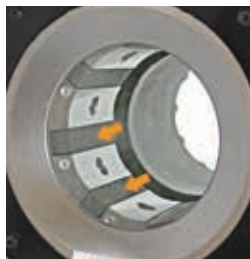

Protective Foam Pads



Hold/Release Valve



Digital Gauge

For additional accessories and replacement parts, please reference the Crimper Operator's Manual.

EQUIPMENT & ACCESSORIES



PC150 Series

The PC150 is a stationary crimper with more power to manufacture factory-quality hose assemblies quickly and easily. Its open design with removable pusher and “slide in” die configuration allows for good visibility and easy loading of dies and hose assemblies. Crimp diameter is set and controlled with an easy-to-read micrometer. Designed to handle higher volumes in a shop environment, the PC150-2 includes the crimper and 2-HP pump on a common base, pressure plate, compression ring, die ring pusher, stop/start remote pendant switch, metric micrometer, adjustable coupling stop, adjustable retraction stop and work light. The optional PC150-1 includes all the components of the PC150-2 and a 1-HP pump.

FEATURES

- › Easy-to-read, fully adjustable metric micrometer allows precise setting of crimp diameters to an accuracy of +/- .1mm
- › Open design with vertical feed for good operator visibility
- › Removable pusher and spring-loaded die set for easy loading
- › 80-ton cylinder
- › Automatic shut-off for precise crimps
- › Adjustable retraction stop limits ram retractions for quick repetitive crimps
- › Adjustable coupling stop for accurate, repetitive positioning of the assembly inside the dies
- › Two-piece, “slide in” die set for easy installation
- › Common base for bench mounting
- › Color-coded die sets to speed die selection and set up
- › 2-HP, 220V AC pump
- › Pneumatic activation (no electric wires) of remote pendant switch

CAPABILITY

- › 1/4" through 1 1/2" ID, 2-braid hose and 4-spiral hose with all coupling styles and most bent tubes

POWER OPTIONS

- › 2-HP, 220V AC, single phase, 50-60 Hz electric pump (PC150-E2 Pump) for PC150-2 crimper
- › Optional 1-HP, 110V AC, single phase, 50-60 Hz electric pump (PC125/150-E1 Pump) for PC150-1 crimper

OIL CAPACITY 1 gal.

MOUNTING Crimper and pump installed on plate

DIMENSIONS 32"L x 16 1/2"W x 29"H

WEIGHT 275 lbs.



PC150
Crimper Series

PC150 DIE SETS

Part #	Description	Color	ID
20244949	PC150-8.5MM	Black	8.5 mm
20244950	PC150-12MM	Black	12 mm
20244951	PC150-14MM	Red	14 mm
20244952	PC150-16MM	Blue	16 mm
20244953	PC150-19MM	Green	19 mm
20244954	PC150-23MM	Yellow	23 mm
20244955	PC150-27MM	Brown	27 mm
20244956	PC150-31MM	Silver	31 mm
20244957	PC150-34MM	Purple	34 mm
20244958	PC150-41MM	Orange	41 mm
20244959	PC150-45MM	Black	45 mm
20244960	PC150-50MM	Black	50 mm
20244961	PC150-56MM	Black	56 mm

OPTIONS

- > **PC150-1 SKIT** Includes PC150-1 crimper and 7 die sets (16 mm, 19 mm, 23 mm, 31 mm, 41 mm, 50 mm and 56 mm dies) for 1/4" to 1 1/2" 1-braid to 4-spiral hose
 - > **PC150-2 SKIT** Includes PC150-2 crimper and 7 die sets (16 mm, 19 mm, 23 mm, 31 mm, 41 mm, 50 mm and 56 mm dies) for 1/4" to 1 1/2" 1-braid to 4-spiral hose
 - > **PC150-Shelf-Black** Die storage shelf unit, 15" D x 20 1/2" W x 16" H, 25 lbs.
- | SKIT # | Item | Description |
|----------|-----------------------|-------------------|
| 20244967 | PC150-1 SKIT | 110V |
| 20244966 | PC150-2 SKIT | 220V Single Phase |
| 20298225 | PC150-1 SKIT (Canada) | 110V |
| 20298226 | PC150-2 SKIT (Canada) | 220V Single Phase |
- > PC150-Spacer Kit for Elbows (20244965)
 - > PC150-1 with 1-HP Pump
 - > PC150-2 with 2-HP Pump

CALIPERS

All crimpers include a Continental caliper.



Standard
SAP 20926931
Ships with crimper



Notched
SAP 20926931

REPLACEMENT PARTS

Part #	Description
20244962	PC150 Die Screw (D200 SCREW)
20244963	PC150 Die Spring (D200 SPRING)

PC150PS Die Storage Shelf
Included



T420 Micrometer
Included



PC150 Die Set
Included

Crimper Features



Coupling Stop



Retraction Stop

For additional accessories and replacement parts, please reference the Crimper Operator's Manual.

PC200i Series

The PC200i is a high-volume, high-capacity stationary crimper utilizing microprocessor control for the fastest, most accurate crimping system available. Crimp settings, dwell time, pre-set start positions and auto/manual operation are all easily set with electronic controls. This production crimper is a quick and easy way to make factory-quality hose assemblies. The standard package is the PC200i-1 crimper which includes a 7.5-HP, 230V/3-phase pump and foot pedal. The optional PC200i-2 crimper includes a 7.5-HP, 480V/3-phase pump and foot pedal. The optional PC200i-3 (single-phase) crimper includes a 5-HP, 220V/single-phase pump and foot pedal.

FEATURES

- › Hose feed is horizontal from both front or rear
- › Accurate electronic PLC crimp diameter adjustment
- › Manual or automatic mode
- › Max die size +78 mm
- › 340-ton cylinder
- › Automatic shut-off for precise crimps
- › Power return stroke and return limit control
- › Rapid retraction of die fingers through hydraulic system
- › Die sets easily changed using hand tool
- › Accommodates bent tube/elbow couplings with the ability of installing 2", 90° fittings on both ends

CAPABILITY

- › 1/4" through 2" ID, 2-braid hose and 2" 6-spiral hose with all coupling end styles and most bent tubes

POWER OPTIONS

- › 7.5-HP, 230V AC, 3 phase, 60 Hz (PC200i-E7.5-1 pump)
- › Optional 7.5-HP, 480V AC, 3 phase, 60 Hz (PC200i-E7.5-2 pump) for the PC200i-2 crimper
- › Optional 5-HP, 220V AC, single phase, 60 Hz for the PC200i-3 crimper

OIL CAPACITY 8 gal.

MOUNTING Bench or cabinet

DIMENSIONS 18 1/2" L x 27 1/2" W x 31 1/2" H (excluding cabinet)

WEIGHT 573 lbs. (excluding cabinet)



PC200i
Crimper Series

PC200 DIE SETS

Part #	Description	ID
20244973	PC200i-8.5MM	8.5 mm
20244974	PC200i-12MM	12 mm
20244975	PC200i-14MM	14 mm
20244976	PC200i-16MM	16 mm
20244977	PC200i-19MM	19 mm
20244978	PC200i-23MM	23 mm
20244979	PC200i-27MM	27 mm
20244980	PC200i-31MM	31 mm
20244981	PC200i-34MM	34 mm
20244982	PC200i-41MM	41 mm
20244983	PC200i-45MM	45 mm
20244984	PC200i-50MM	50 mm
20244985	PC200i-56MM	56 mm
20244986	PC200i-62MM	62 mm
20244987	PC200i-69MM	69 mm
20244988	PC200i-74MM	74 mm
20249869	PC200i-75MM	75 mm
20249890	PC200i-78MM	78 mm

OPTIONAL CrimpIQ™ CONTROLLER SKITS

All SKITs come with the following die sets: 16 mm, 19 mm, 23 mm, 27 mm, 31 mm, 34 mm, 41 mm, 50 mm, 56 mm, 62 mm, 69 mm, 78 mm dies for 1/4" to 2" 1-braid to 6-spiral hose



*CrimpIQ™
Controller*

Part #	Description
21006005	PC200i 230V,1P
21006000	PC200i 230V, 3P
21006081	PC200i 230V, 1P (3SKIT)
21006082	PC200i 230V, 1P (SKIT) (CDN)
21006080	PC200i 230V, 1P (1SKIT)
21006083	PC200i 230V, 3P (SKIT) (CDN)
21006011	PC200i 480V, 3P (3SKIT)
21006013	PC200i 575V, 3P (SKIT) (CDN)

CALIPERS

All crimpers include a Continental caliper.



Standard
SAP 20926931
Ships with crimper



Notched
SAP 20926931



Die Cabinet

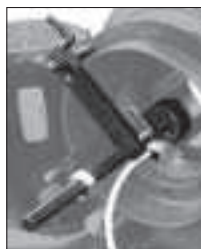

Optional Automatic
Back Stop



PC200 Die Set



Foot Switch

OPTIONS

Part #	Description
20244971	PC200-MBS Manual Back Stop
20244972	PC200-EBS Electric Back Stop

REPLACEMENT PARTS

Part #	Description
20267266	PC200/400 Die Change Tool
20269407	PC200 Die Lock Pin
20828391	PC200/400 CrimpX Grease, 14 oz. tube
20244995	PC900 AerosolLube
20244994	PC900 Grease, 1 lb.
20244993	PC900 Grease, 3 oz.
20419635	PC200 Foam Pads

PC440i Series

The patented ACT™ Crimp Controller can store up to 50 dies and 150 crimp settings. Its pressure transducer monitors crimping “effort” eliminating “trial and error” crimping. The PC440i can track number of crimps and automatically pause for a quality check at a preset intervals. It automatically converts inches to millimeters and millimeters to inches so that no calculation is ever required.

FEATURES

- › Hose feed is horizontal from either front or rear
- › Accurate electronic PLC crimp diameter adjustment
- › Manual or automatic mode
- › Maximum die opening: die closed diameter + 78 mm (hydraulic) and 122 mm (industrial)
- › 265-ton cylinder
- › Automatic shut-off for precise crimps
- › Power return stroke and return limit control
- › Rapid retraction of die fingers through hydraulic system
- › Die sets easily changed using hand tool
- › Accommodates bent tube/elbow couplings with the ability of installing 2", 90° fittings on both ends

CAPABILITY

- › 1/4" through 2" ID, 2-braid hose, 2" 6-spiral hose and 4" industrial hose with all coupling end styles including most bent tubes
- › 1/2" through 4" ID industrial hose

POWER OPTIONS

- › 7.5-HP, 230V AC, 3 phase, 60 Hz for the PC400i crimper
- › Optional 5-HP, 230V AC, single phase for the PC400i-1 crimper

OIL CAPACITY 8 gal.

MOUNTING Bench or cabinet

DIMENSIONS 18 1/2" L x 27 1/2" W x 31 1/2" H (excluding cabinet)

WEIGHT 573 lbs. (excluding cabinet)



PC440i Crimper with CrimpIQ™ Controller

PC440 DIE SETS

Hydraulic Dies

Part #	Description	OD
20835207	PC440i-8.5MM	99 mm
20835208	PC440i-12MM	99 mm
20835209	PC440i-14MM	99 mm
20835250	PC440i-16MM	99 mm
20835251	PC440i-19MM	99 mm
20835252	PC440i-23MM	99 mm
20835253	PC440i-27MM	99 mm
20835254	PC440i-31MM	99 mm
20835255	PC440i-34MM	99 mm
20835256	PC440i-41MM	99 mm
20835257	PC440i-45MM	99 mm
20835258	PC440i-50MM	99 mm
20835259	PC440i-56MM	99 mm
20835260	PC440i-62MM	99 mm
20835261	PC440i-69MM	99 mm
20835262	PC440i-74MM	99 mm

OPTIONAL CrimpIQ™ CONTROLLER SKITS

All SKITs come with the following die sets: 16 mm, 19 mm, 23 mm, 27 mm, 31 mm, 34 mm, 41 mm, 45 mm, 50 mm, 56 mm, 62 mm, 69 mm, 74 mm, 78 mm



*CrimpIQ™
Controller*

Part #	Description
21006007	PC440i 230 V, 1P
21006002	PC440i 230 V, 3P
21006084	PC440i 230 V, 1P SKIT
21006085	PC440i 230 V, 3P SKIT

CALIPERS

All crimpers include a Continental caliper.



Standard
SAP 20926931
Ships with crimper



Notched
SAP 20926931

Crimper Features

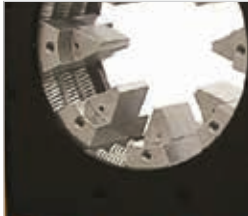

Master Die Location Holes



Adjustable Back Stop

Master Dies 160 to 99 mm Adapter Dies 99 mm Hydraulic Dies

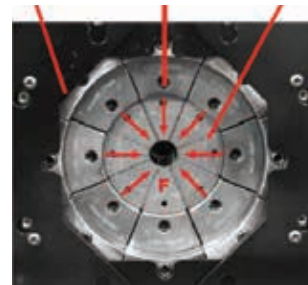

Fixed 6:00 die for easy positioning of fittings

OPTIONS

Part #	Description
20244971	PC200-MBS Manual Back Stop
20244972	PC200-EBS Electric Back Stop

REPLACEMENT PARTS

Part #	Description
20244995	PC900 AerosolLube
20244994	PC900 Grease, 1 lb.
20244993	PC900 Grease, 3 oz.
20828391	PC200/400 CrimpX Grease, 14 oz. tube
101641	(Custom Crimp #) PC440 Die Lock Pins

For additional accessories and replacement parts, please reference the Crimper Operator's Manual.

EQUIPMENT & ACCESSORIES



PC600i Series

The PC600i is a high-volume, high-capacity stationary crimper utilizing the fully automatic ACT3™ microprocessor controller. The PC600i can produce 2,200 crimps per hour with 350 tons of crimping force to allow for both hydraulic and industrial hose assemblies, and it is ideal for production assembly applications. The standard PC600i crimper includes a 7.5-HP, 230V AC, 3-phase hydraulic pump.

FEATURES

- › Fully automatic ACT3™ controller
- › Manual and automatic operation
- › Utilizes the PC200i/400i dies with easy-to-change die tool
- › 350-ton cylinder
- › Built-in heavy-duty base with die holders
- › Allows for 2,200 crimps per hour
- › Automatic shut-off for precise crimps
- › Power return stroke and return limit control

CAPABILITY

- › 1/4" through 2 1/2" ID, 2-braid and 6-spiral hydraulic hose
- › 3/16" through 6" ID industrial hose

POWER OPTIONS 7.5-HP, 230V AC, 3-Phase, 60 Hz

DIMENSIONS

- › Master die inside diameter: 145 mm
- › Master die opening w/o dies: 273 mm
- › Maximum swaging diameter: 192 mm
- › Maximum die opening: Die + 128 mm
- › Pump size: 21" L x 34" W x 36 1/2" H
- › Pump weight: 450 lbs. (205 kg)
- › Machine size: 22" L x 36" W x 57" H

WEIGHT

4,500 lbs. (2,041 kg) (Die base and cabinet shipping weight)



PC600i
Crimper Series



Optional Automatic
Back Stop

PC600iL DIE SETS

Part #	Description
20244976	PC200i-16MM
20244977	PC200i-19MM
20244978	PC200i-23MM
20244980	PC200i-31MM
20244982	PC200i-41MM
20244984	PC200i-50MM
20244985	PC200i-56MM
20244986	PC200i-62MM
20244987	PC200i-69MM
20249890	PC200i-78MM

OPTIONAL CrimpIQ™ CONTROLLER SKITS

All SKITs come with the following die sets: 16 mm, 19 mm, 23 mm, 31 mm, 34 mm, 41 mm, 50 mm, 56 mm, 62 mm, 69 mm, 78 mm



*CrimpIQ™
Controller*

Part #	Description
21006021	PC600iL-2P 480V, 3P SKIT
21006086	PC600iL-P 230V, 3P SKIT
21006008	PC600iL 230V, 1P
21006003	PC600iL-1P 230V, 3P
21006087	PC600iL-1P 230V, 3P
21006090	PC600iL-2PX 480V, 3P SKIT
21006088	PC600iL-PX 230V, 3P SKIT
21006089	PC600iL-1PX 230V, 1P SKIT

OPTIONS

Part #	Description
20244971	PC200-MBS Manual Back Stop
20244972	PC200-EBS Electric Back Stop

CALIPERS

All crimpers include a Continental caliper.



Standard
SAP 20926931
Ships with crimper



Notched
SAP 20926931

ADDITIONAL DIES

Part #	Description
20258403	PC600i 122 mm Long Die Set
20562098	PC600i 84 mm Long Die Set
20562099	PC600i 92 mm Long Die Set
20562650	PC600i 100 mm Long Die Set
20562651	PC600i 108 mm Long Die Set
20562652	PC600i 116 mm Long Die Set
20562653	PC600i 126 mm Long Die Set
20562654	PC600i 166 mm Long Die Set
20562655	PC600i 178 mm Long Die Set
20673573	PC600iL 84 mm Long Die Set
20673574	PC600iL 92 mm Long Die Set
20673575	PC600iL 100 mm Long Die Set
20673576	PC600iL 108 mm Long Die Set
20673577	PC600iL 116 mm Long Die Set
20673578	PC600iL 126 mm Long Die Set
20679260	PC600iL 100 mm Long Die Set
20685703	PC600iL 86 mm Long Die Set
20685704	PC600iL 90 mm Long Die Set
20685705	PC600iL 118 mm Long Die Set
20708156	PC600iL 116 mm Long Die Set
20742520	PC600iL 89 mm Long Die Set
20802397	PC600iL 114 mm Long Die Set

REPLACEMENT PARTS

Part #	Description
20776806	PC600 Master/PC1000 Adapter Die Locking Screw
20828391	PC200/400 CrimpX Grease, 14 oz. tube
20244995	PC900 AerosolLube
20244994	PC900 Grease, 1 lb.
20244993	PC900 Grease, 3 oz.

For additional accessories and replacement parts, please reference the Crimper Operator's Manual.

PC1000i Series

The PC1000i is a high-volume, high-capacity stationary crimper utilizing the fully automatic ACT3™ microprocessor controller. The PC1000i can produce 1,415 crimps per hour with 450 tons of crimping force to allow for both hydraulic and industrial hose assemblies, ideal for production assembly applications. The standard PC1000i crimper includes a 7.5-HP, 230V AC, 3-phase hydraulic pump.

FEATURES

- › Fully automatic ACT3™ controller
- › Manual and automatic operation
- › Utilizes the PC200i/400i dies with easy-to-change die tool
- › 450-ton cylinder
- › Built-in heavy-duty base with die holders
- › Allows for 1,415 crimps per hour
- › Automatic shut-off for precise crimps
- › Power return stroke and return limit control

CAPABILITY

- › Up through 2½" ID, 2-braid, 4-spiral and 6-spiral hydraulic hose
- › 3/16" through 10" ID industrial hose

POWER OPTIONS

- › Standard: 7.5-HP, 230V AC, 3 phase, 60 Hz
- › Optional: 7.5-HP, 440V AC, 3 phase, 60 Hz

DIMENSIONS

- › Master die inside diameter: 230 mm
- › Master die opening w/o dies: 350 mm
- › Maximum swaging diameter: 192 mm
- › Maximum die opening: Die +125 mm
- › Machine size: 30" L x 44" W x 74" H

WEIGHT 6,185 lbs. (2,806 kg)



PC1000i DIE SETS

Part #	Description	ID
20244975	PC200i-14MM	14 mm
20244976	PC200i-16MM	16 mm
20244977	PC200i-19MM	19 mm
20244978	PC200i-23MM	23 mm
20244980	PC200i-31MM	31 mm
20244982	PC200i-41MM	41 mm
20244984	PC200i-50MM	50 mm
20244985	PC200i-56MM	56 mm
20244986	PC200i-62MM	62 mm
20244987	PC200i-69MM	69 mm
20249890	PC200i-78MM	78 mm
20562098	PC600i-84MM	84 mm
20562099	PC600i-92MM	92 mm
20562650	PC600i-100MM	100 mm
20562651	PC600i-108MM	108 mm
20562652	PC600i-116MM	116 mm
20562653	PC600i-126MM	126 mm
20590712	PC1000i-166MM	166 mm
20590713	PC1000i-178MM	178 mm
20590714	PC1000i-215MM	215 mm
20590715	PC1000i-245MM	245 mm

OPTIONAL CrimpIQ™ CONTROLLER SKITS

All SKITs come with the following die sets: 16 mm, 19 mm, 23 mm, 31 mm, 34 mm, 41 mm, 50 mm, 56 mm, 62 mm, 69 mm, 78 mm



*CrimplIQ™
Controller*

Part #	Description
21006009	PC1000i-PX 230V, 3P SKIT
21006004	PC1000i 230V, 3P
21006091	PC1000i 230V, 3P SKIT

CALIPERS

All crimpers include a Continental caliper.



Standard
SAP 20926931
Ships with crimper



Notched
SAP 20926931

ADDITIONAL DIES

Part #	Description
20590712	PC1000i 166 mm DIA x 159 mm Long Industrial Die
20590713	PC1000i 178 mm DIA x 159 mm Long Industrial Die
20708157	PC1000i 190 mm DIA x 159 mm Long Industrial Die
20590714	215 mm DIA Scalloped Die Set
20590715	245 mm DIA Scalloped Die Set

OPTIONS

Part #	Description
20244971	PC200-MBS Manual Back Stop
20244972	PC200-EBS Electric Back Stop

REPLACEMENT PARTS

Part #	Description
20776806	PC600 Master/PC1000 Adapter Die Locking Screw (70 mm)
20776807	PC1000 Adapter Die Long Locking Screw (100 mm)
20776808	PC1000 Adapter Die Short Locking Screw (30 mm)
20828391	PC200/400 CrimpX Grease, 14 oz. tube
20244995	PC900 AerosolLube
20244994	PC900 Grease, 1 lb.
20244993	PC900 Grease, 3 oz.

For additional accessories and replacement parts, please reference the Crimper Operator's Manual.

PCTB Series Test Benches

PCTB-1500 & PCTB-2500

Continental PCTB Test Benches provide a safe and efficient method to test hose assemblies for burst or proof testing.



PCTB1500
Test Bench



PCTB1500
Test Bench

FEATURES

- › Optional electronic model with programmable control including paper printout
- › 1/2" polycarbonate safety window
- › Safety lock to prevent operation when door is not closed
- › Standard garden hose inlet for water supply
- › Factory air inlet supply, 85 psi minimum required
- › Powder-coated finish for durability
- › Polyurethane bed liner material coating on interior
- › 7-port outlet manifold for multiple testing
- › Built-in work light for good visibility during testing

CAPABILITY

- › PCTB-1500 - Test pressure range to 21,500 psi (1500 bar)
- › PCTB-2500 - Test pressure range to 37,500 psi (2500 bar)

POWER OPTIONS

Standard 110V AC, single-phase grounded outlet

DIMENSIONS

- › Interior: 18" H x 35" W x 71" L
- › Includes test bench legs - test area at a convenient working height
- › Full opening allows for hose assemblies to be loaded on a skid

WEIGHT 750 lbs.

CONTINENTAL PART NUMBERS

SAP #	Part #
20439763	PCTB-1500 TEST BENCH
20439764	PCTB-1500 PLC TEST BENCH
20554088	PCTB-2500 TEST BENCH
20554089	PCTB-2500 PLC TEST BENCH

HS Series Hose Saws

HS150



The HS150 is designed to cut 1- and 2-braid hydraulic hose up to 1 1/2" ID and up to 1 1/4" 4-spiral hose.

FEATURES

- > 1-HP
- > Single phase
- > 60 Hz
- > 115V AC
- > 3450 RPM with 10" serrated blade

CUTTING CAPABILITY 1 1/4" (4-wire) up to 1" (6-wire)

DIMENSIONS 28 3/4" L x 21" W x 12 1/4" H

WEIGHT 70 lbs.

TECHNICAL DATA

Part #	Voltage	Phase	Amps
20614553	110	1	15

HS150 Mobile Hose Saw



The new HS150 Mobile Hose Saw is ideal for on-site service where electricity is not available. For more information, contact Continental customer service.

FEATURES

- > 12V DC
- > 3450 RPM with 10" serrated blade

CUTTING CAPABILITY 1 1/4" (4-wire), 3/4" (6-wire)

DIMENSIONS 28 3/4" L x 21" W x 12 1/4" H

WEIGHT 70 lbs.

TECHNICAL DATA

Part #	Voltage	Phase	Amps
20829262	12 DC	1	15

Blade Information for HS150



Scalloped Blade
(General Purpose)



Double Bevel Blade
with SS Slots

Blade Type	Part #	Blade Size Diameter	Arbor Size	Alternative Part #
Serrated (Included)	20683699	10 in.	1 in.	
Scalloped (Available)		10 in.	1 in.	104034
Double Bevel with SS Slots (Available)	20804794	10 in.	1 in.	

Hose Saws

HS150 / HS150 Mobile

EQUIPMENT & ACCESSORIES



HS Series Hose Saws

HS501



Designed to cut 1- and 2-braid hydraulic hose up to 2" ID and up to 2" 4- or 6-spiral hose.

FEATURES

- > 5-HP
- > Single phase
- > 60 Hz
- > 230V AC
- > 3450 RPM with 12" serrated blade

CUTTING CAPABILITY 1 ¼" (4-wire) up to 2" (6-wire)

DIMENSIONS 29 ¾" L x 26 ¾" W x 16" H

WEIGHT 120 lbs.

TECHNICAL DATA

Part #	Voltage	Phase	Amps
20614557	230	1	30

HS503



Designed to cut 1- and 2-braid hydraulic hose up to 2" ID and up to 2" 4- or 6-spiral hose.

FEATURES

- > 5-HP
- > Three phase
- > 60 Hz
- > 230V AC
- > 3450 RPM with 12" serrated blade

CUTTING CAPABILITY 1 ¼" (4-wire) up to 2" (6-wire)

DIMENSIONS 29 ¾" L x 26 ¾" W x 16" H

WEIGHT 120 lbs.

TECHNICAL DATA

Part #	Voltage	Phase	Amps
20614556	230	3	20

Blade Information for HS501 & HS503



Scalloped Blade
(General Purpose)



Double Bevel Blade
with SS Slots

Blade Type	Part #	Blade Size Diameter	Arbor Size	Alternative Part #
Serrated (Included)	20922988	12 in.	1 in.	
Scalloped (Available)		12 in.	1 in.	
Double Bevel with SS Slots (Available)	20680700	12 in.	1 in.	102210

Blade Awareness

Blade Conditioning

New blades must be properly conditioned to assure long life and clean cuts. For the first ten cuts, feed the blade slowly through a medium-sized hose. This will properly break-in and condition the blade for long life.

The hose should begin to bend before contacting the blade. This will increase blade life and keep the hose from tearing and deforming.

Once the blade and motor reach full RPM, apply steady downward pressure on the handle in order to force the hose into the blade. Do not apply enough force to stall the blade. Ease up on the pressure before the blade completes the cut. This will keep from separating the wires as the blade exits the hose.

The edges of the blade may appear to be dull. This does not mean that the blade is not effective.

As long as the blade is giving clean cuts, do not replace the blade.

CAUTION: Cracks can cause extreme damage to the blade. Periodically examine the blade for cracks and/or broken teeth.



Damaged Blade

Blade Types



Serrated Blade

Pay close attention to the direction of rotation marked on the serrated blade. It is the opposite of most blades of this type.



Scalloped Blade



Double Bevel
with SS Slots Blade

Hose Reel Rack



Continental introduces a new product from its extended product line, the Hose Reel Rack to keep the hose spools organized and secure.

The Hose Reel Rack is made of heavy-duty steel and comes in 2 compact designs (24" and 36" wide) to accommodate your needs.

FEATURES

- › 5 different positions for customizable configurations that fit various sized hose spools
- › 2 reels for 2 larger hose spools, or 3 reels for 3 smaller hose spools
- › 3 reels are included (additional reels are available)
- › Easy installation, hardware included
- › Reel rack can be bolted to the floor for maximum stability

	24" Hose Reel Rack	36" Hose Reel Rack
SAP #	21024821	21024823
HOSE CAPACITY	600 lbs.	600 lbs.
DIMENSIONS	72 ½" H x 36" L x 30" W	72 ½" H x 36" L x 42" W
WEIGHT	119 lbs.	128 lbs.
COLOR	Black powder coat	Black powder coat

Fitting Cabinet

CB101

SAP# 20240780

DIMENSIONS 41 ½" W x 12 ½" L x 21" H

MATERIAL Heavy gauge steel

WEIGHT 60 lbs.

COLOR Black powder coat

CAPACITY 4 sliding drawers, 38" wide; each shelf can hold 10 small plastic bins or 5 large plastic bins

FEATURES

- › 20 and 22 GA prime cold-rolled steel
- › Spot weld construction
- › Black texture powder coat finish
- › Heavy duty ball bearing slides
- › Four slide-out shelves with removable plastic bins for easy access
- › Cabinet can hold 40 small bins or 20 large bins, or a combination of the two
- › Made in the USA



OPTIONS

SAP #	Part #	Description
20240781	CB200	Set of 5 large (7 ¾") plastic bins
20240782	CB201	Set of 10 small (3 ¼") plastic bins
20240784	CB301	Set of stationary legs (Bolt-on with pre-drilled holes)

ASSEMBLIES



Selecting the Proper Hose Assembly

In order to obtain the best service from any particular hose application, two important conditions must be fulfilled:

1. **Select the right hose for the job**
2. **Make sure that it is fitted correctly and used in the proper manner**

Carefully consider the application requirements. A helpful guide is the S.T.A.M.P.E.D. process. **S.T.A.M.P.E.D.** is an acronym that stands for the seven major information areas required to provide a quality hose assembly.

S	SIZE	ID, OD and length of the assembly
T	TEMPERATURE	Includes temperature of fluid conveyed and the climatic conditions
A	APPLICATION	The conditions of use including abrasion, flexing and routing
M	MATERIAL	Type of material conveyed including composition and concentration
P	PRESSURE	Hose assembly working pressure and surge or back pressure
E	ENDS	Definition of the fitting including thread type, gender, bent tube, swivel and orientation
D	DELIVERY	Time allowed for delivery, including testing, quality assurance and packaging

To assist in obtaining and conveying information regarding the application, a copy of the S.T.A.M.P.E.D. application form is included in this catalog. This inquiry sheet can be sent to any Continental authorized distributor for a hose recommendation.

Please Note:

A hose should always be selected based on its **rated working pressure**. Do not use **minimum burst pressure** as a guideline in selecting the hose. Minimum burst pressure decreases over the use and life of the hose. A hose should be selected based on its rated working pressure to provide a normal service life. In addition, always select a hose by giving consideration to its recommended temperature limits. Hose service life is reduced if the temperatures of the fluids being conveyed or ambient temperatures exceed the recommended limits.

S.T.A.M.P.E.D. Form

SIZE

ID _____

OD _____

Hose Length (OAL or uncoupled) _____

Tolerances _____

TEMPERATURE

of Material Being Conveyed
(high, low, ambient) _____

Intermittent? _____

Constant? _____

Sub-Zero Exposure _____

APPLICATION

Indoor and/or Outdoor Use _____

Intermittent or Continuous Use _____

Flexibility Required (min. bend radius) _____

Movement (static, vibrations, flexing) _____

External Conditions _____

Abrasion _____

Oil _____

Solvents _____

Acid _____

Ozone _____

Electrical/Static Conductive _____

Oil Resistance _____

Tube _____

Cover _____

Flame Resistance _____

Non-contaminating Materials _____

Hose Currently in Use _____

Current Hose Service Life
(failure description) _____

Service Life Desired _____

MATERIAL

Solids (size, description) _____

Gaseous (volatility, inert) _____

Liquids (flammability, causticity, acid,
alkaline, solution/concentration) _____

Chemical Names (generic) _____

PRESSURE

Working Pressure (including surges) _____

Burst Pressure _____

Suction or Vacuum Requirements _____

Velocity _____

Impulse _____

ENDS & FITTINGS

Type of Threads _____

Male/Female _____

Reusable/Non-reusable _____

Material for Fittings _____

Swivel or Non-swivel _____

Straight or Bent Tube _____

Fitting 1 & 2 Orientation _____

Other _____

Cut to Length _____

Crimp Specs or Crimper Used _____

DELIVERY

Lead Time _____

Quantity _____

Stock/Nonstock _____

Special Print _____

Special Packaging _____

Other Information

Date: _____

Customer: _____

Customer Number: _____

Ship To: _____

Bill To: _____

Telephone: _____

Fax: _____

S.T.A.M.P.E.D.

Selecting the Proper Hose Assembly

ASSEMBLIES



Defining Hose & Assembly Length

Identifying Hose ID

In the case of a hose assembly replacement, the inside diameter (ID) of the hose can be obtained from the existing assembly. The ID may be printed on the layline of the hose or may have to be measured. Before cutting the assembly, measure the overall assembly length and record the orientation of the fittings. See the following sections on how to measure overall assembly length and the offset angle between the two fittings. If the ID of the hose has not been determined, utilize the Hose ID Selection Nomograph in the Appendix. The chart will yield a Hose ID recommendation based on flow capacity and flow velocity.

Hydraulic hose size or inside diameter is sometimes referred to as the "Dash Size." The Dash number is the ID of the hose in sixteenths of an inch. For example, a 1/4" ID hose, is equivalent to 4/16". The "Dash Size" would be "-4." A listing of the Dash sizes is shown below. Note that the Dash number applies to the Hose ID for all hose except SAE 100R5. In the case of SAE 100R5, the Dash number is equal to a relevant tube outside diameter (OD).

Dash #	Hose ID (Except SAE 100R5)		SAE Dash Size* (SAE 100R5)	
	in.	mm	in.	mm
-2	1/8	3.2		
-3	3/16	4.8		
-4	1/4	6.4	3/16	4.8
-5	5/16	7.9	1/4	6.4
-6	3/8	9.5	5/16	7.9
-8	1/2	12.7	13/32	10.3
-10	5/8	15.9	1/2	12.7
-12	3/4	19.1	5/8	15.9
-14	7/8	22.2		
-16	1	25.4	7/8	22.2
-20	1 ¼	31.8	1 ½	28.6
-24	1 ½	38.1	1 ¾	35.0
-32	2	50.8	1 13/16	46.0
-36	2 ¼	57.6		
-40	2 ½	63.5	2 ¾	60.3
-48	3	76.2		
-56	3 ½	88.9		
-64	4	101.6		
-72	4 ½	115.2		

*SAE Dash Size equals OD of the tubing, which has approximately the same ID as the hose, expressed in 1/16".

Identifying Overall Assembly Length

Unless otherwise specified by the customer, the assembly's overall length is measured from the extreme end of one fitting to the extreme end of the other except for the O-ring face seal fittings, which must be measured from the sealing face. Where elbow fittings are used, measurement shall be to the centerline of the sealing surface of the elbow end.

Assembly Length Measurements

Overall Assembly Length

Female Swivel Ends (except O-Ring Face Seal) measure to sealing surface.

Male Ends

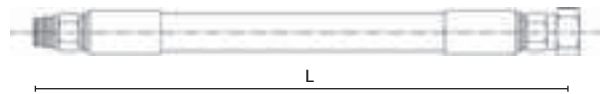

Bent Stem Swivel Female Ends

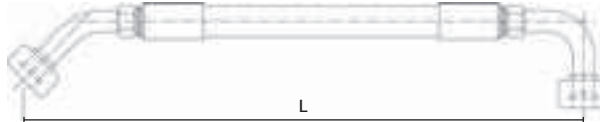

Flange Ends

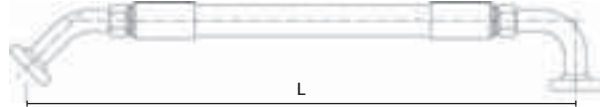

Swivel O-Ring Face Seal Ends

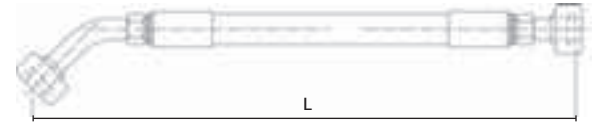

Determining Hose Cut Length

The hose cut length for a hose assembly is calculated by subtracting the cut-off factor (distance from the bottom of the ferrule or collar to the end of the fitting or an internal sealing surface), denoted as "C" cut-off in the tables, from the actual assembly length required.

The "C" cut-off factor can be obtained from the fitting product tables. An example is shown below:

Part	Hose ID		Hose Dash Size	Thread Size	Thread Dash Size	"C" Cut-Off Factor	Stem Hex
	in.	mm					
JIC Solid Male 37	3/8	9.5	-6	9/16 - 18	-6	26.3	17

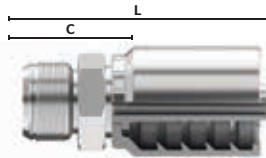

Knowing the overall length of the assembly desired, you subtract the "C" cut-off factor for each fitting from the overall length to obtain the hose cut length.

Cut Hose Length = Assembly Overall Length - (C1+C2)

C1 and C2 are cut-off factors for each end. The "C" dimension may differ for each end, depending on the fitting. In certain situations, the sealing surface of JIC swivels and O-ring face seals should be considered when calculating overall length.

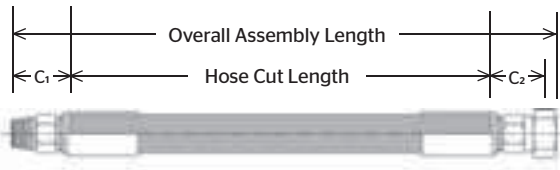

Hose assemblies should be manufactured to the following length tolerances:

Assembly Length	Tolerance (+/- in.)	Tolerance (+/- in.)	Tolerance (+/- mm)
Up through 12 in. (304.8 mm)	0.13	1/8	3.2
Over 12 through 18 in. (304.8 mm through 457.2 mm)	0.19	3/16	4.8
Over 18 through 36 in. (457.2 mm through 914.4 mm)	0.25	1/4	6.4
Over 36 in. (914.4 mm)	1%	1%	1%

*SAE Dash Size equals OD of the tubing, which has approximately the same ID as the hose, expressed 1/16".

Measuring the Offset Angle

The offset angle between two fittings is the number of degrees measured in a clockwise direction between the fitting nearest the viewer and the farthest end fitting. Tolerances on the offset angle are +/- 3 degrees for assemblies up to 24 inches long and +/- 5 degrees for assemblies 24 inches and longer.

The following illustration shows the clockwise angle separation between a "close" fitting and a "far" fitting. The "close" fitting would be defined as the fitting closer when looking at an assembly end to end. The "far" fitting would be defined as the fitting on the far end of the assembly when looking at an assembly end to end. The "far" end is used as the reference point and the "close" end establishes the angular difference.

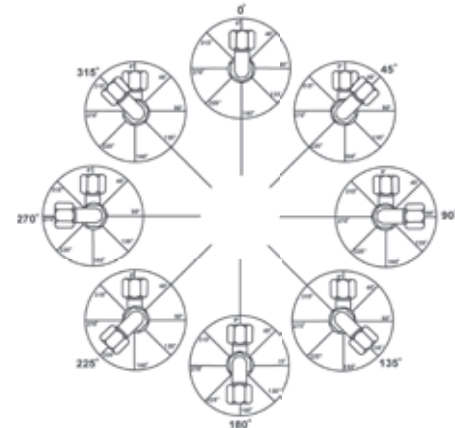

Far End Reference Measuring Clockwise



Clockwise Measurement (Degrees)



Hose Assembly Instructions

Ultra-Crimp™ 1-Piece Crimped Fittings



Fitting inserted on hose.

1. Determine correct hose length from desired hose assembly length and "C" dimension. The "C" dimension, or cut-off factor, can be found in the fitting tables. More information on using the "C" dimension can be found in the previous subtopic, "Defining Hose and Assembly Length."
2. Cut hose to required length using a cut-off saw or a circular abrasive cut-off wheel. The preferred choice would be the steel wheel with a cooling agent. Care should be taken in not overheating the hose. Overheating can cause deformation of the hose and create difficulty when inserting the hose fittings. For textile-reinforced hose, a guillotine-style cutter may be used.



Cut-Off Saw. Use caution when operating power equipment. Follow the proper safety measures per manufacturer suggestions.

3. Ensure hose is cut squarely.

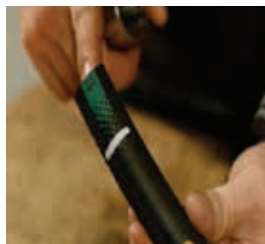

Hose with square cut.

4. Contaminated hose may reduce the service life of hydraulic systems. Always clean the hose bore after cutting, using air and/or flush with a compatible fluid.
5. In certain situations, skiving may be required. Skiving is the process of removing the portion of hose cover that lies directly under the coupling ferrule. This allows the metal fitting to be coupled directly on the hose reinforcement. Skiving is further discussed in the following section under the subtopic of "Internal and External Skiving."
6. Push and seat hose into the fitting. It is essential that the fitting be mated with a compatible hose style. Check fitting compatibility in hose or fitting product tables. To determine the insertion depth of the hose coupling, first measure the distance from the bottom of the fitting to the end of the ferrule where the hose is to be inserted. Mark a line on the hose cover at the distance from the end of the hose that equals the insertion depth. This becomes the visual check to determine if the hose was fully inserted in the fitting.



Mark insertion depth.

It is sometimes difficult to insert a fitting into hydraulic hose. If necessary, it is recommended using a liquid soap or a water/soap solution as a lubricant. Use the lubricant sparingly. When installing elbow fittings, point elbow toward the curvature of the hose, unless specified otherwise. When installing elbow fittings on both ends, see the previous section on "Measuring the Offset Angle." If the insertion mark was correctly applied, you should now be able to determine if the coupling has been completely inserted. The depth mark will be aligned with the end of the ferrule. In the case of a skived assembly, check that no skive shows and that couplings are on straight.

Hose Assembly Instructions

Ultra-Crimp™ 1-Piece Crimped Fittings



Fitting inserted on hose.

7. Before crimping hose fitting, verify the tooling setup and install the proper die set. Read the Crimp Chart, per Continental recommendations, and dial in the correct crimp diameter.

8. Place hose and fitting into the crimp machine. Crimp ferrule to predetermined diameter. Refer to the Continental Crimp Specifications Manual for proper crimp diameters and the crimper operator's manual for further instructions on how to properly and safely operate the crimper.



Always verify proper die set. Insert die set in crimper.



Set crimp diameter.



Insert hose assembly into crimper die set.

Hose Assembly Instructions

Ultra-Crimp™ 1-Piece Crimped Fittings

9. Remove assembled end and check crimp diameter with caliper or micrometer. Crimp diameter should be measured at the center of the ferrule. Measure the smooth portion of the ferrule and not the ridges. Visually check for cracked, cocked or damaged fittings.



Verify crimp diameter with calipers.

10. Some applications require the addition of a protective outer sleeving or strain reliefs. If this is a requirement, the most appropriate time to assemble is before the second end fitting is applied. Choose the appropriate product for the specific application. When cutting product to length, allow for flexing and bending of the hose.
11. Even if not required, it is a good practice to examine and audit the assembly before delivery or use. Records should be maintained. The level of inspection should be in compliance with the quality plan.
 - a. Inspection - Visual, dimensional and proof pressure testing in accordance with SAE J517 or SAE J343.
 - b. Clean or flush of the assembly to remove plating dust, rubber chips, etc.
 - c. Apply caps, if required, to protect fitting threads and keep out contamination.
 - d. Apply labels or specific markings, if required.
 - e. Package the assembly properly.

Final Inspection Checklist

- › Bulge behind the fitting
- › Cocked fittings
- › Cracked fittings
- › Rusted fittings
- › Exposed reinforcement
- › Freedom of swivels
- › General appearance of the assembly
- › Internal contaminants
- › Restriction of the tube

Recommended Inspection Equipment

- › Worktable suitable for inspection
- › Tape measure to measure overall length
- › Calipers for measuring crimp diameter
- › Pi tape to measure outside diameter
- › Plug gauges for measuring inside diameter
- › Protractor device for measuring angle orientation of bent tube fittings
- › Magnifying glass and light to view inside of assemblies
- › Burst- and proof-pressure tester

Hose Assembly Instructions

Uni-Crimp™ 2-Piece Crimped Fittings



1. Determine correct hose length from desired hose assembly length and "C" dimension. The "C" dimension, or cut-off factor, can be found in the fitting tables. More information on using the "C" dimension can be found in the previous subtopic, "Defining Hose and Assembly Length."
2. Cut hose to required length using a cut-off saw or a circular abrasive cut-off wheel. The preferred choice would be the steel wheel with a cooling agent. Care should be taken in not overheating the hose, which can cause deformation of the hose and create difficulty when inserting the hose fittings. For textile-reinforced hose, a guillotine-style cutter may be used.



Cut-off saw. Use caution when operating power equipment. Follow the proper safety measures per manufacturer suggestions.

3. Ensure hose is cut squarely.

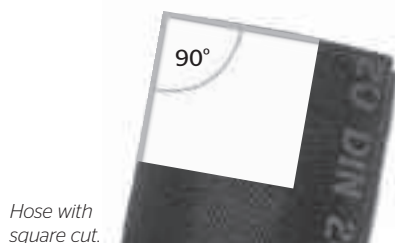

Hose with square cut.

4. Contaminated hose may reduce the service life of hydraulic systems. Always clean the hose bore after cutting, using air and/or flush with a compatible fluid.
5. In certain situations, skiving may be required. Skiving is the process of removing the portion of hose cover that lies directly under the coupling ferrule. This allows the metal fitting to be coupled directly on the hose reinforcement. Skiving is further discussed in the following section under the subtopic of "Internal and External Skiving."

6. The 2-piece crimped fitting consists of a ferrule and a stem insert. It is essential that the fitting be mated with a compatible hose style. Check fitting compatibility in hose or fitting product tables. Screw and/or push ferrule onto the hose until hose bottoms into the ferrule.



Push ferrule onto hose.

7. Push the stem insert into the Hose ID. The shoulder of the stem should make contact with ferrule. It is sometimes difficult to insert the stem into hydraulic hose. If necessary, it is recommended to use a liquid soap or a water/soap solution as a lubricant. Use the lubricant sparingly. When installing elbow fittings, point elbow toward the curvature of the hose, unless specified otherwise. When installing elbow fittings on both ends, see the previous subtopic on "Measuring the Offset Angle."



Push stem into Hose ID.

Hose Assembly Instructions

Uni-Crimp™ 2-Piece Crimped Fittings

8. Before crimping hose fitting, verify the tooling setup and install the proper die set. Read the Crimp Chart, per Continental recommendations, and dial in the correct crimp diameter.



Always verify proper die set. Insert die set in crimper.



Set crimp diameter.

9. Place hose and fitting into the crimp machine. Refer to the Continental Crimp Specifications Manual for proper crimp diameters and the Crimper Operator's Manual for further instructions on how to properly and safely operate the crimper.



Insert hose assembly into crimper die set.

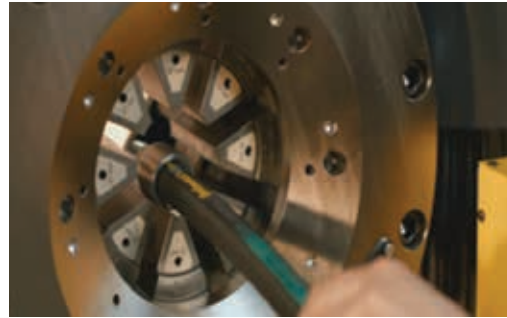

Crimp the hose/fitting assembly.

10. Remove assembled end and check crimp diameter with caliper or micrometer. Crimp diameter should be measured at the center of the ferrule. Measure the smooth portion of the ferrule and not the ridges. Visually check for cracked, cocked or damaged fittings.



Verify crimp diameter with calipers.

11. Even if not required, it is a good practice to examine and audit the assembly before delivery or use. Records should be maintained. The level of inspection should be in compliance with the quality plan.
- Inspection - Visual, dimensional and proof pressure testing in accordance with SAE J517 or SAE J343.
 - Clean or flush of the assembly to remove plating dust, rubber chips, etc.
 - Apply caps, if required, to protect fitting threads and keep out contamination.
 - Apply labels or specific markings, if required.
 - Package the assembly properly.

Refer to the Final Inspection Checklist and Recommended Inspection Equipment previously listed in Hose Assembly Instructions for a 1-Piece Crimped Fitting.

Hose Assembly Instructions

Field-Grip™ Fittings

Continental Field-Grip™ reusable hose fittings must be carefully matched with a Continental hose. Use Field-Grip™ fittings only designed specifically for Continental hose. Use the correct socket with a given hose. Specific fittings and their hose application can be found in the fitting tables.

1. Determine correct hose length from desired hose assembly length and "C" dimension. The "C" dimension, or cut-off factor, can be found in the fitting tables. More information on using the "C" dimension can be found in the previous subtopic, "Defining Hose and Assembly Length."
2. Cut hose to the required length using a cut-off saw or a circular abrasive cut-off wheel. The preferred choice would be a steel wheel with a cooling agent. Care should be taken in not overheating the hose, which can cause deformation of the hose, creating difficulty when inserting the hose fittings.

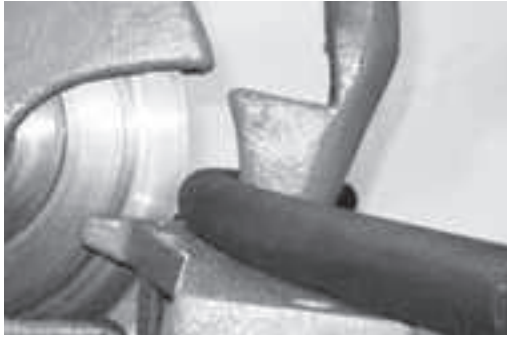

Cut-off saw. Use caution when operating power equipment. Follow the proper safety measures per manufacturer suggestions.

3. Ensure hose is cut squarely.

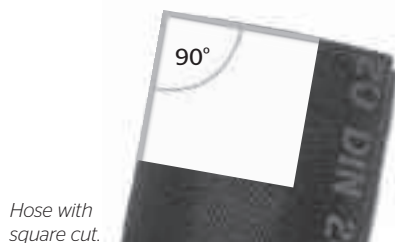

Hose with square cut.

4. Contaminated hose may reduce the service life of hydraulic systems. Always clean the hose bore after cutting, using air and/or flush with a compatible fluid.



Field-Grip™ fitting stem and a socket.

5. A Field-Grip™ fitting consists of a socket and stem assembly. It is essential the fitting be mated with a compatible hose style. Check fitting compatibility in hose or fitting product tables. Place the socket in a vice. The socket will fit over the hose cover. To determine the insertion depth for the hose, first measure the distance from the bottom of the socket to the end of the socket where the hose is to be inserted. Transfer this insertion depth to the hose cover by measuring from the end of the hose. Mark a line on the hose cover at the distance from the end of the hose that equals the insertion depth. This becomes the visual check to determine if the hose was fully inserted in the socket.



Socket positioned in vice.



Mark insertion depth.

Hose Assembly Instructions

Field-Grip™ Fittings

6. Lightly lubricate hose cover with a mild soap solution. Screw end of hose counterclockwise until hose reaches the marked insertion depth and then back off a 1/2 turn. If the insertion mark was correctly applied to the hose, you should now be able to determine if the socket has been correctly applied to the hose by using the insertion depth mark on the hose cover as a reference, along with a visual check inside the socket.
7. Lightly lubricate the inside of the hose and stem threads with a mild soap solution. Using a wrench, screw the stem assembly into the socket until the stem hex shoulders against the socket.
8. If disassembly is necessary, reverse the process.



Apply lubricant to hose cover.



Visually check hose position inside socket.



Apply lubricant to stem and hose tube.



Screw stem into socket.



Stem properly seated against socket.

Internal & External Skiving

Skiving is the process of stripping and removing the hose cover to allow the proper installation of crimped hose ends and to ensure the best possible hose assembly.

1. At the point of skiving, the hose has been cut to the proper length. See Steps 1 and 2 in the previous hose assembly instructions.
2. Obtain length of skive per Continental specifications. Mark hose with skive length.

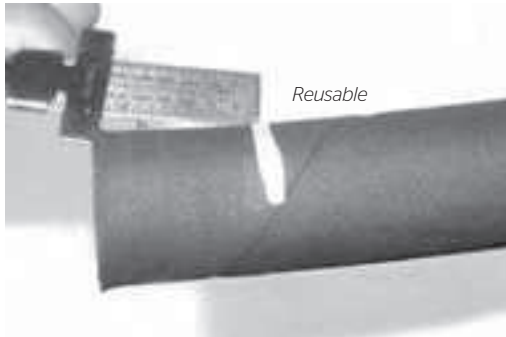

Mark skive on hose cover.

3. Remove the hose cover to the wire, using care not to burn, fray or damage reinforcement wires. The cover of wire-braided hose can be removed with a buffing wheel or a hand skiver. A manual, external skiving tool that uses a knife must be used with spiral hose. Mark the length of the cover to be removed, as noted in the Continental Crimp Specifications Manual, and set skiving depth on the manual skiving tool. Make sure the manual skiver is rotated in the counterclockwise direction for external skiving. Follow specific instructions on external skiving that would accompany the manual skiver.



Cutting skive with buffing wheel. Follow manufacturer recommendation for the safe and proper use of the skiver.

4. With the hose cover removed, check that the wire braid or spiral reinforcement has not been displaced, damaged or cut in the skiving process.



Check skived cover.

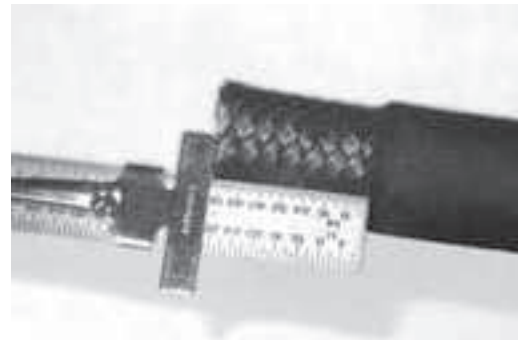

Measure skive.

5. Check for the proper skive length.
6. Hose should be checked for 100% of cover removal. If necessary, rebuff skived area to clean and remove hose cover.
7. A manual, internal skiving tool that uses a knife is to be used to remove the tube material of the spiral hose for installation of the Dual-Grip fittings. Note the correct length of tube material to be removed from the Continental Crimp Specification Manual. Set the desired skiving depth on the internal skiving tool. Make sure the tool rotates in the clockwise direction for internal skiving. Verify that the correct length of tube material has been removed. Follow specific instructions on internal skiving that would accompany the manual skiver.
8. It is important to clean the Hose ID by brushing, blowing compressed air or flushing to remove any contaminants.

Warning: Failure to completely remove the cover may result in serious personal injury or property damage due to hose ends blowing off, leakage or other failures.

SR14A Hose Assembly Instructions

In order to make a quality assembly with SR14A hose, the following instruction must be followed:

1. Tape hose before cutting.

This will prevent the wire from flaring once the cut is made. If wire flare is allowed to occur, the ferrule will not slide onto the hose.



Tape hose before cutting.

2. Slip ferrules on. Be sure they are in the correct direction (i.e., flange side aims to the outside of the hose).



Hose with attached ferrules.

3. Push in on stem on each end.
4. Remove the tape and slide the ferrule onto the stem.

5. Crimp the fitting using proper die selection and setting. Be sure not to allow the ferrule to slip back onto the hose or ride up on the hub of the stem. The groove of the ferrule must line up with flange of the stem.

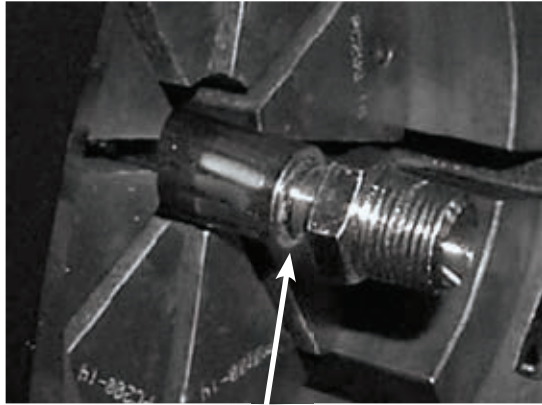
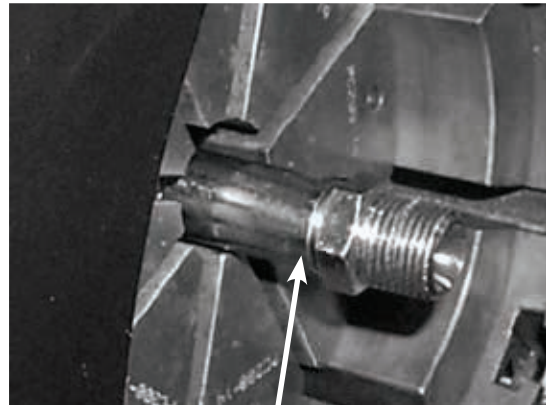
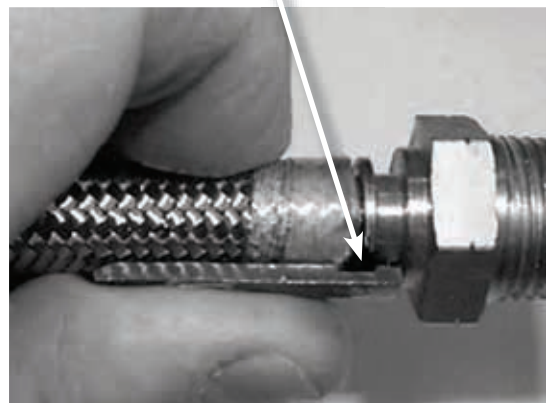
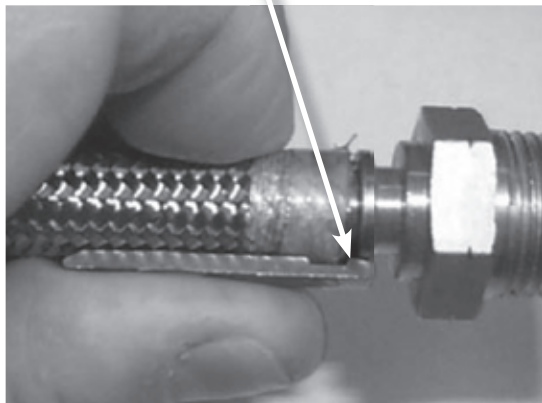
**WRONG****RIGHT**

6. Check finished crimp diameter.



Completed assembly.

Cool Clip® AC Hose Assembly Instructions

Special care should be taken when selecting the proper refrigerant hose and fittings. Continental Cool Clip® fittings should only be used with Continental Galaxy® 4890 hose.

Special care must be taken when working with refrigerant systems. Sudden escape of refrigerant gases may result in blindness or severe injury. Continental recommends adherence to guidelines and general practices as defined in SAE J2211 for the service containment of HFC-134a as well as all applicable EPA guidelines and procedures concerning the service of refrigerant systems.

1. Cut the hose to proper length with the Continental Hose Cutting Tool (Part # 65090).

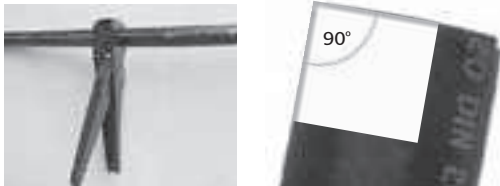

The cut must be made squarely to the hose length.

2. Install two proper-sized clips into the clipholder. For ease of assembly, both clips should have the same orientation.

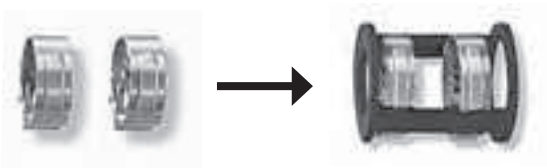

3. Place the clipholder with the two clips on the hose. Install the clipholder so that the end with the smallest hole touches the end of the hose.
4. Lubricate the fitting with a generous amount of the AC system's lubricator oil. This is to lower the force of the insertion.

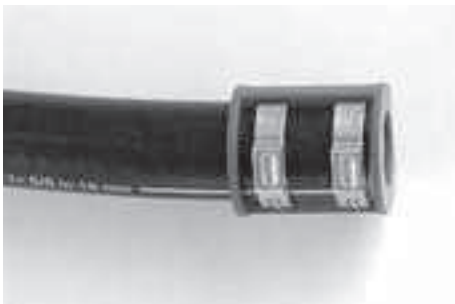

5. Insert the fitting into the hose. Ensure that the fitting is fully inserted so that there is no gap between the end of the hose, the clip retainer and the shoulder of the fitting.

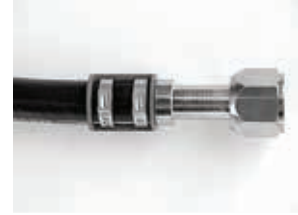

6. Close both clips with the Continental clip pliers, PN GC-Pliers-0001. The pliers will automatically release when the clips have been completely closed. Start with the clip closer to the end of the hose.



7. Now you have realized a durable hose/fitting connection.

Warning - Selection of Fittings

Selection of the proper Continental hose and fittings for the application is essential to the proper operation and safe use of the hose and related equipment. Inadequate attention to the selection of the hose and fitting for the application can result in hose leakage, bursting or other failures which can cause serious bodily injury or property damage from spraying fluids or flying projectiles. Some of the factors involved in the selection of the proper hose and fittings are:

Hose

- › Size
- › Refrigerant
- › Pressure
- › Length
- › Bends
- › Original Equipment

Fittings

- › Compatibility
- › Pressure
- › Temperature
- › Hose Design
- › Installation Design
- › Corrosion Requirements

If there are any questions as to what fitting should be used, Continental recommends that you consult a local Sales Representative or Continental Hydraulics Application Group for assistance.

AC Fitting Crimping Procedures

PC125 Crimper

1. Insert the pressure plate into the bottom flange of the crimper, making sure that it is seated completely into the bottom flange.



2. Select the correct die set for the Galaxy® hose dash size/ID and "AC" fitting being crimped. Insert the two halves of the die set onto the pressure plate, making sure both halves are flat and level.

Galaxy® Hose #	ID (in.)	PC125 Die Set
G4826-06	5/16	PC125-AC06
G4826-08	13/32	PC125-AC08
G4826-10	1/2	PC125-AC12
G4826-12	5/8	PC125-AC12
G4826-14	3/4	PC125-AC12

BE SURE TO lubricate the contact surfaces, both bottom and outside edges of the die fingers, the inside of the compression ring and the pressure plate with the die lubricant provided with the crimper. Only use a molybdenum/graphite high-pressure grease applied sparingly to the contact surfaces. Die lubricant can be obtained from Continental using part numbers PC900-Grease (3 oz.) or PC900-Grease (1 lb.) An aerosol lubricant, PC900-AerosolLube, can also be used.

Failure to lubricate the contact surfaces with the correct lubricant will cause the dies to seize in the compression ring, causing damage to the dial set as well as possibly damaging the crimper.

3. Place the compression ring loosely but evenly over the die set. Make sure the die set is correctly aligned.
4. Slide the pusher in place.



5. Set the micrometer to the setting as shown in the Continental Crimp Specification Manual for the combination of hose and fitting being crimped. The metric micrometer (readings of 0 to 10) is a direct-reading micrometer. The setting on the micrometer is added to the number in millimeters etched on the die ring to obtain the final crimp diameter. The adjuster, set at "0," is the setting for the die set fully closed. For example, with a 34 mm die and the micrometer set at 3.0 mm, the finished crimp diameter would be 37.0 mm (34 mm + 3.0 mm).
6. Attach the coupling stop, included with your crimper, to the base of the crimper.

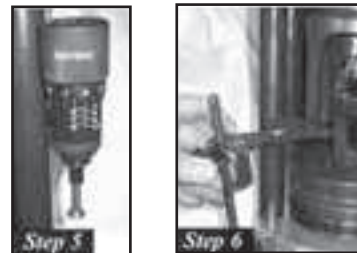

Select the appropriate Galaxy® hose size and cut to the correct length using Continental Hose Cutting Tool (part #65090). Be sure the hose is cut squarely at a 90° angle to the hose.

7. Insert the hose end fully into the ferrule of the corresponding fitting. When completely inserted, the hose should be visible through the witness hole on the side of the ferrule.



AC Fitting Crimping Procedures

PC125 Crimper

- Insert the hose and fitting through the crimp dies. Align the foot on the coupling stop so that the foot rests on the top of the crimp die and also against the end of the fitting ferrule. Be sure the foot on the coupling stop is against the end of the ferrule and not resting on the bump of the tube above the ferrule.
- Manually depress the compression ring, closing the die set until the hose and fitting are held loosely in the die set. Seat the compression ring evenly on the die set.



Each die set has a limited range of diameters for which a satisfactory crimp can be obtained.

Always consult the Continental Crimp Specification Manual for selecting the correct die set.

CAUTION: The notches on the die set must be completely covered by the compression ring prior to starting the crimp. If the notches are showing, you must go to a larger die set. Crimping with an incorrect die size could result in personal injury.



- Recheck the fitting for the correct alignment in the die set and depress the start/stop switch. Hold the start/stop switch until the automatic stop switch shuts the pump off. Release the start/stop switch and allow the pusher to return to the retracted position.



- Check the crimp diameter of the finished assembly with a caliper or micrometer to be certain that it is within the specifications as outlined in the Continental Crimp Specification Manual. The caliper measurement should be taken in the crimp groove between the ridges as shown.



To properly measure the crimp diameter on "AC" style fittings, your caliper should be a style having notched blades (pictured above).

- Check the completed assembly to be sure that the hose is still visible through the witness hole on the fitting. Also, the crimp grooves should be centered on the fitting ferrule.



If the crimp grooves are too near the fitting end of the ferrule, or too near the hose end of the ferrule, the fitting may not seal properly and the assembly could leak. If your finished crimp assembly resembles either of the two examples shown below, the end of the ferrule was not properly positioned against the coupling stop foot, or the coupling stop foot was not resting on the top of the die set when crimped. A new assembly should be crimped, being sure to follow the procedures in Step 9.



INSTALLATION & MAINTENANCE



Service Life Factors

Hose and hose assemblies have a finite life. There are a number of factors that will reduce hose life.

Consideration should be given to the following factors.

1. Operating Pressure - The maximum operating pressure within the hose should not exceed the recommended working pressure as specified by Continental as shown in the catalog specifications. Hose selection must be made so that the recommended maximum operating pressure is equal to or greater than the system pressure. Burst pressure, which is four times the working pressure, should not be used as the operating pressure of the hose. Exposing the hose to pressures higher than the working pressure is dangerous and will shorten hose life.
2. Exposing the hose to a surge pressure, above the working pressure of the hose, will shorten hose life. If surges are severe, select a hose with a higher recommended working pressure.
3. Burst Pressure - The burst pressure should never be considered in a hydraulic system design. The burst pressure is for test purposes only. Burst pressure is detrimental to the hose.
4. Operating Temperatures - High heat conditions may have an adverse affect on hose due to the degradation of the rubber and the affect on fitting retention. Continuous use at or above the maximum operating temperature of the hose will cause deterioration of the tube, cover and reinforcement, reducing the hose life. Care should be taken to ensure that fluid and ambient temperatures, both static and transient, do not exceed the limitations of the hose. It is important to operate a hose assembly within the specified temperature range of the specific hose.
5. Bend Radius - Flexing the hose to less than its recommended minimum bend radius will decrease hose life. Optimize routing to minimize inherent problems.
6. Excessive external forces such as flexing, twisting or kinking will reduce hose life. Use the correct fitting or adapter to prevent any unnecessary external force.
7. Chemical Resistance - Consider the chemical resistance of the tube, cover and the fitting, including the O-ring, to maximize hose performance and life. Hose selection must assure compatibility of the hose, tube, cover and fittings with the fluid used.
8. The size of the hose assembly components must be adequate to keep pressure losses to a minimum and avoid damage to the hose due to heat generation or excessive turbulence.
9. Extend hose assembly life by making sure hose and fittings are compatible with the environment or sufficiently protected from the elements, such as ultraviolet light, ozone, salt water or chemicals that can cause degradation of assembly components and shorten hose life.
10. A hose is designed with a certain level of abrasion resistance, but care should be taken to avoid excessive abrasion, which can damage the hose cover, accelerating hose failure.
11. Use the proper end fittings and crimp or install to the proper crimp specification to ensure a safe and proper hose assembly. Make sure that hose fittings are compatible with the hose.

Safety Considerations

Fabricators, end users and installers should be aware of the safety factors when handling or when in proximity of hydraulic hose assemblies. The following are some potential conditions that can lead to personal injury and property damage.

1. As certain fluids may permeate the hose cover, the hose should always be used in well-ventilated areas.
2. Hydraulic systems generally operate at very high pressures. Any leak of pressurized fluid can penetrate the skin, causing severe tissue damage and burns. Consider the use of guards or shields around the hose assembly to reduce the risk of injury.
3. Whipping Hose - Under high operating pressures, the hose and/or fitting can come loose or blow, causing the end of the hose to whip with great force. Again, the hose assembly should be shielded or guarded, even possibly secured, to avoid injury or damage from this whipping action.
4. Hydraulic fluids are flammable and can explode with a source of ignition. To avoid possible injury or property damage, care should be taken to eliminate ignition sources and to properly route the hose assembly to minimize the chance of combustion.
5. Most all hose are conductive. In some cases a non-conductive hose is required. To avoid electrocution or other serious mishap, the correct hose specification, either conductive or non-conductive, should be used.
6. Should a hydraulic hose assembly fail, loss of hydraulic pressure will impact the operation of equipment. Care should be taken that a sudden power loss of the equipment will not cause personal injury.
7. When air or gaseous materials are being conveyed, the correct hose should be used. A pin-perforated cover may be required. Perforations in the cover will prevent permeated gasses from accumulating and blistering the cover. Check with Continental for the correct hose specification.
8. Extreme care should be used when operating handheld hydraulic tools where the operator is in proximity to the hydraulic hose assembly. The following steps should be taken to avoid injury.
 - a. Use strain relievers on each end of the hose to prevent kinking, excessive bending or stress on the hose at the coupling.
 - b. Never use the hose assembly to pull or carry the tool.
 - c. Exposed hose near the operator should be guarded in case the hose assembly fails, to prevent injury from high-pressure or high-temperature fluid.
 - d. Operators of the tool should be protected with the required safety clothing, considering the job and fluids being used.
 - e. The hose should be protected against any external damage.
9. Hose assemblies should be properly routed to avoid strain and the possibility of the hose bursting. Proper routing will also protect the assembly against flex fatigue, excessive heat or abrasion.
10. When selecting a hose style and assembly, check for hose compliance to all relevant government, industry and safety standards or regulations.

Proper Installation & Hose Routing

Proper Hose Installation

WARNING: Improper selection, installation or maintenance of a hose assembly may result in premature failures, bodily injury or property damage.

The following practices should be used when replacing a hydraulic hose assembly or installing a new hydraulic assembly:

1. A pre-installation inspection should include the following:
 - a. Check to ensure the hose is the correct specification in style, size and length.
 - b. Check that the hose assembly has no visible non-conformity.
 - c. Check the fittings for any damage including nicks or burrs.
 - d. Check that the hose is routed properly using suggested guidelines.
 - e. Check that the hose is not damaged (kinked, crushed or twisted).
2. Handle assembly with care. Avoid bending hose beyond the recommended bend radius.
3. Hose assemblies should not be installed in a torqued or twisted condition.
4. Use necessary restraints and protective devices when necessary to reduce wear and stress points on the assembly.

Correct Assembly Installation & Routing

Satisfactory performance and appearance depend upon proper hose installation. Excessive length destroys the trim appearance of an installation and unnecessarily adds to the cost of the equipment. Hose assemblies of insufficient length to permit adequate flexing, expansion or contraction, will cause poor power transmission and shorten the life of the hose.

The diagrams below offer suggestions for proper hose installations to obtain the maximum in performance and economy.

Since hose may change in length from +2% to -4% under the surge of high pressure, provide sufficient slack for expansion and contraction.

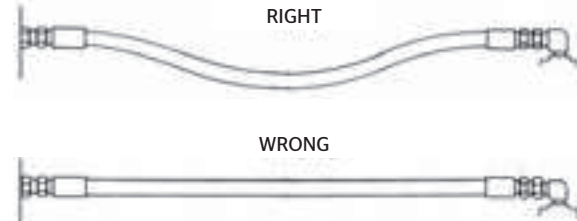

Obtain direct routing of the hose through use of 45° and 90° adapters and fittings. Improve appearance by avoiding excessive hose length.

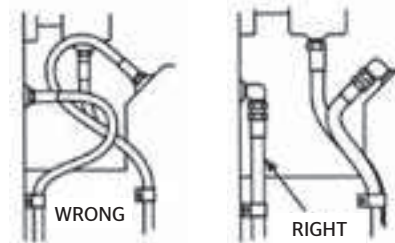

Avoid a sharp twist or bend in the hose by using proper angle adapters compatible with the hose.

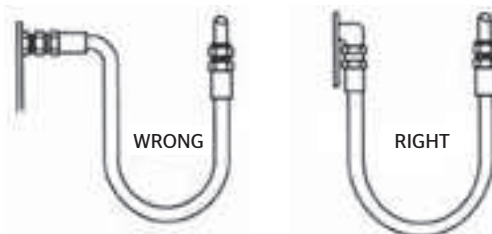

Correct Assembly Installation & Routing

Due to changes in length when the hose is pressurized, do not clamp at bends so the curves can absorb changes and protect the hose with a spring guard. Do not clamp high- and low-pressure lines together, and protect the hose with a spring guard.

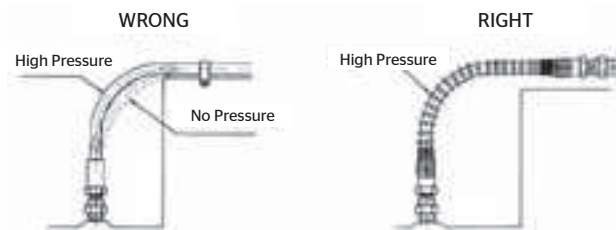

Where the radius falls below the required minimum, an angle adapter should be used as shown on the previous page to avoid sharp bends in the hose.

Adequate hose length is very important to distribute movement on flexing applications and to avoid abrasion.

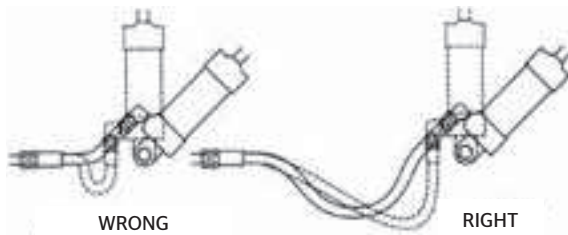

To avoid twisting in hose lines bent in two planes, clamp hose at change of plane, as shown.

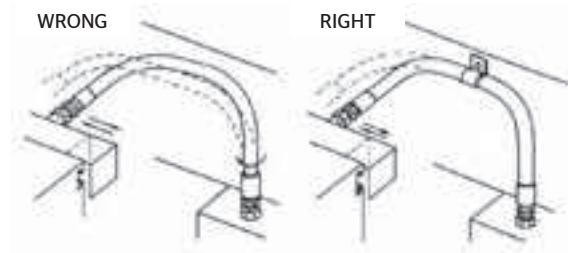

Hose should not be twisted. Hose is weakened when installed in a twisted position. Also, pressure in twisted hose tends to loosen fitting connections. Design is such that the machine motion produces bending rather than twisting.



To prevent twisting and distortion, the hose should be bent in the same plane as the motion of the boss to which the hose is connected.

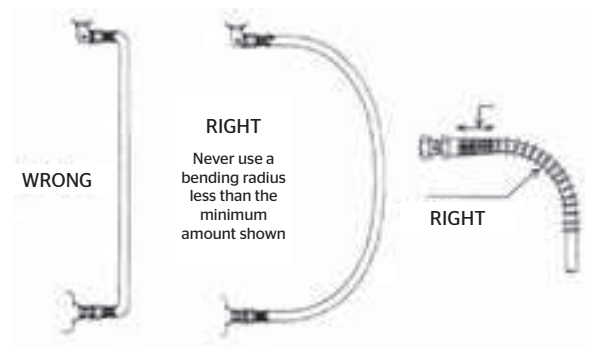

Never use a bending radius less than the minimum shown in the hose specification tables. To reduce collapsing of line and restriction of flow, avoid a sharp bend in the hose by using the proper spring guard. Exceeding minimum bend radius will greatly reduce hose assembly life.

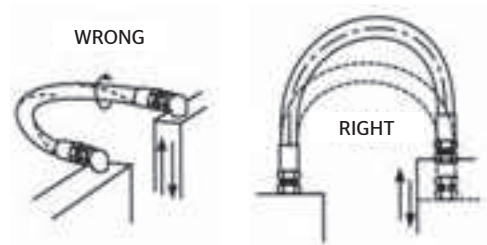

Hose Maintenance & Storage

Hose Maintenance

A hose and fitting maintenance program can reduce equipment downtime and maintain peak operating performance of the hydraulic system. Here are a few maintenance reminders.

1. Hose assemblies should be inspected on a regular basis with frequency based on prior history of the equipment, a set maintenance/inspection program and the severity of the application or risk potential.
2. Always use Safety Considerations (page 443) when inspecting hose assemblies. To avoid personal injury during system checkouts, do not touch the assembly and be aware of the potentially hazardous area surrounding the hose assembly.
3. Inspect hose and fittings for the following:
 - a. Exposed, broken or corroded reinforcement wires.
 - b. Leaks in the hose or at the fitting.
 - c. Cracked, damaged or corroded fittings.
 - d. Other signs of significant deterioration.

If any of the above conditions exist, the hose assembly should be replaced immediately.
4. The hydraulic system should also be inspected for the following:
 - a. Leaking ports.
 - b. Damaged or missing hose clamps, guards or shields.
 - c. Excessive dirt or grease on the assembly.
 - d. Condition of system fluid, fluid temperature, contamination and air entrapment.

If any of the above conditions are found, the appropriate corrective action should be taken.

5. Functional tests should be conducted to determine if systems are leak-free and operating properly. Hose assemblies of insufficient length to permit adequate flexing, expansion or contraction will cause poor power transmission and shorten the life of the hose.
6. If hose assembly can be inspected and detached from the hydraulic system, additional steps can be taken to ensure a properly maintained assembly:
 - a. With hose assembly detached, clean assembly by blowing it out with clean, compressed air or by rinsing it with a compatible cleaning fluid.
 - b. Inspect hose tube for cuts, obstructions and cleanliness.
 - c. Check layline of the hose to make sure the hose is not twisted.
 - d. Check fittings to ensure they are in good condition and properly crimped or attached to the assembly.

If any of the above conditions are found, the hose assembly should be replaced.
7. The hose assembly should be hydrostatically tested, using the approved test stands and procedures as outlined in SAE J517. Test at proof pressure, or twice the working pressure of the hose, for 30 seconds to one minute. When test pressure is reached, visually inspect the hose for any signs of weakness, leaks or any hose movement relative to the fitting that would indicate a loose fitting. If any of these conditions exist, the assembly should be replaced.
8. Specific hose assembly replacement intervals must be considered based on previous service life, government or industry recommendations, or when failures could result in injury risk or property damage.

Hose Storage

Temperature, humidity, ozone, sunlight, oils, solvents, corrosive liquids, insects, rodents and radioactive materials can adversely impact hose products. Hose should be stored in a dark, dry atmosphere away from heat sources, electrical equipment and the above adverse elements. The ideal storage temperature for rubber hose is 50°F to 70°F (10°C to 21.1°C), with a maximum of 100°F (37.8°C).

APPENDIX



Fitting Identification

Measuring Threads and Seat Angles

Tools Required: ID/OD Calipers, Seat Angle Gauge (English and Metric), Thread Pitch Gauge

Measuring Threads

A caliper is used to measure the OD of male threads and the ID of female threads. Measure at the largest point. In some cases, threads may be worn, and the exact measurement taken may not match exactly to the thread charts. For accuracy, it is recommended the male thread be measured.

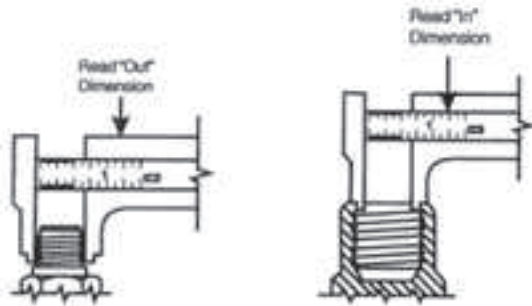

Measuring Seat Angle

A Seat Angle Gauge is used to measure the angle of the sealing surface. For either male or female fittings, place the gauge on the sealing surface. An accurate reading is taken when the gauge is parallel to the centerline of the coupling.

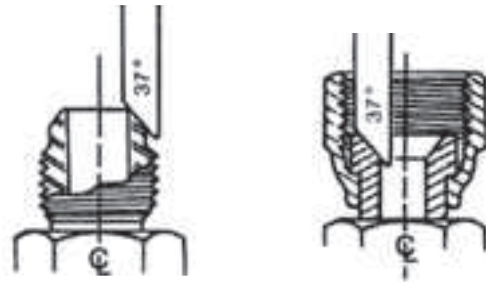

Measuring Thread Pitch

A Thread Pitch Gauge is used to determine the number of threads per inch or the distance between threads in a metric connection. To ensure an accurate reading, make sure the fit of the thread gauge is snug.

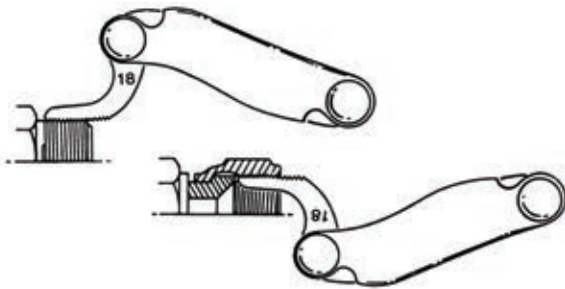

Comparing Measurements to the Tables

ID/OD measurements, thread pitch and seat angle will be used to identify the fitting. Measurements taken can be used to compare with the dimensions found on charts in the following pages.

As an example, a fitting will be defined as:
Continental B2-NPMX-0606 with 3/8"-18" threads.

From the hydraulic catalog, the fitting can be identified as a NPTF / Male / Swivel.

The -6 fitting has 3/8"-18" threads, which can be identified using calipers, thread gauge and the following tables.

Fitting Identification

Fitting Standards

There are five basic fitting standards: North American, British, French, German and Japanese

North American Thread Types

Also known as American Dryseal Pipe Threads, the thread types include NPTF, NPSF and NPSM.

N National	S Straight Thread
F Fuels	P Pipe
T Tapered Thread	M Mechanical Joint

Pipe threads can be either straight or tapered. The first step in identifying this fitting is to determine if the thread is parallel (straight) or tapered.



Tapered Threads

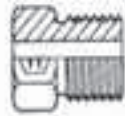

Parallel Threads

A straight thread is not used for sealing fluids. In this type of fitting, a seal is achieved with an O-ring, a metal seal or a seat machined into the end of the fitting. A straight thread can be determined by laying a straightedge against the threads. If all the threads are parallel to the centerline of the fitting, then it is a straight thread.

A tapered thread seals by the interference in the engagement of the male and female threads. These threads deform when they are tightened, causing metal deformation and a pressure-tight joint. Thread sealants are commonly used in this connection. A tapered thread can be determined by laying a straightedge against the threads. If the straightedge is not parallel to the centerline of the fitting and the threads taper toward the centerline of the fitting, then it is a tapered thread.

A fitting may also be referred to by its Dash Size number. The Dash Size number is a universal abbreviation for sizing pipe systems. The following charts will show a Dash Size number for each fitting. The Dash Size number comes from the dimension of the port of the fitting. It is the dimension in 1/16 of an inch. A 3/8" port would be 6/16" or a Dash Size of 6 (-6).

Inch	1/16	Dash Size #
1/8	2/16	-2
1/4	4/16	-4
3/8	6/16	-6
1/2	8/16	-8
3/4	12/16	-12
1	16/16	-16
1 ¼	20/16	-20
1 ½	24/16	-24
2	32/16	-32

Fitting Standards

North American Thread Types

NPTF

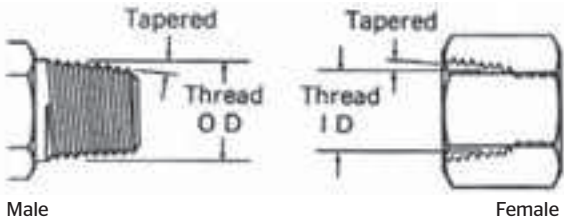

Identification

National Pipe Tapered Fuels. Tapered thread.

Seal

The thread is tapered and sealing takes place with the deformation of the threads. The NPTF male has a 30° seat and will mate with the NPTF female, also with tapered threads, but no seat. A thread sealant is commonly used. An NPTF male with a 30° seat will mate with an NPSM female, which has straight threads and a 30° inverted seat. The sealing takes place on the 30° seat.

Application

The NPTF fitting is a dryseal thread, commonly used in fluid power systems but not recommended by the National Fluid Power Association for hydraulic applications.

NPSM

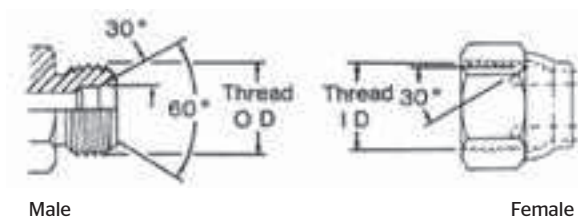

Identification

National Pipe Straight Mechanical. Straight thread.

Seal

Both male and female have a straight thread and a 30° seat and chamfer. The seal takes place by compression of the 30° seat on the chamfer. The threads hold the connection mechanically.

Application

Used in fluid power systems.

Thread Identification Table

NPTF / NPSF / NPSM

Dash Size	Nominal Size	Thread Size	Female Thread ID	Male Thread OD
	in.		in.	in.
-2	1/8	1/8 - 27	23/64	13/32
-4	1/4	1/4 - 18	15/32	35/64
-6	3/8	3/8 - 18	19/32	43/64
-8	1/2	1/2 - 14	3/4	27/32
-12	3/4	3/4 - 14	61/64	1 1/16
-16	1	1 - 11 1/2	1 1/64	1 1/16
-20	1 1/4	1 1/4 - 11 1/2	1 7/32	1 4/16
-24	1 1/2	1 1/2 - 11 1/2	1 25/32	1 29/32
-32	2	2 - 11 1/2	2 1/4	2 3/8

Fitting Standards

North American SAE Thread Types

JIC 37° Flare (SAE J514)

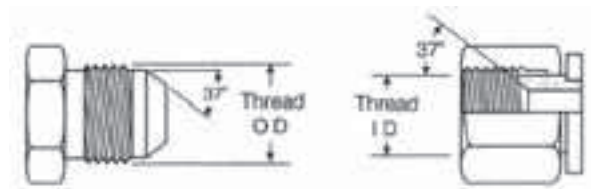

Male

Female

Identification

Straight threads. Both male and female have a 37° seat.

Seal

The seal is made on the 37° flare seat. The threads hold the connection mechanically. Only connect male SAE 37 with female SAE 37.

Application

SAE specifies use with high-pressure hydraulic tubing.

Thread Identification Table

JIC 37° Flare

Dash Size	Nominal Size	Thread Size	Female Thread ID	Male Thread OD
	in.		in.	in.
-2	1/8	5/16-24	17/64	5/16
-3	3/16	3/8-24	21/64	3/8
-4	1/4	7/16-20	25/64	7/16
-5	5/16	1/2-20	29/64	1/2
-6	3/8	9/16-18	1/2	9/16
-8	1/2	3/4-16	11/16	3/4
-10	5/8	7/8-14	13/16	7/8
-12	3/4	1 1/16-12	31/32	1 1/16
-14	7/8	1 3/16-12	1 1/4	1 3/16
-16	1	1 5/16-12	1 5/16	1 5/16
-20	1 1/4	1 5/8-12	1 3/4	1 5/8
-24	1 1/2	1 7/8-12	1 5/4	1 7/8
-32	2	2 1/2-12	2 3/4	2 1/2

SAE 45° Flare (SAE J512)

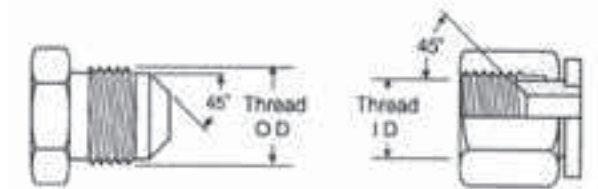

Male

Female

Identification

Straight threads. Both male and female have 45° seat.

Seal

The seal is made on the 45° flare seat. The threads hold the connection mechanically. Only connect male SAE 45 with female SAE 45.

Application

Commonly used in low-pressure, refrigeration and automotive piping systems and are frequently constructed of brass and connected to copper tubing.

Comments

Use caution when identifying this fitting as the threads are the same as SAE J512 37° (JIC) in the -2, -3, -4, -5, -8 and -10 sizes. The sealing surface angles are different, however.

Thread Identification Table

SAE 45° Flare

Dash Size	Nominal Size	Thread Size	Female Thread ID	Male Thread OD
	in.		in.	in.
-2	1/8	5/16-24	17/64	5/16
-3	3/16	3/8-24	21/64	3/8
-4	1/4	7/16-20	25/64	7/16
-5	5/16	1/2-20	29/64	1/2
-6	3/8	5/8-18	9/16	5/8
-7	7/16	11/16-16	5/8	11/16
-8	1/2	3/4-16	11/16	3/4
-10	5/8	7/8-14	13/16	7/8
-12	3/4	1 1/16-14	63/64	1 1/16

Fitting Standards

North American SAE Thread Types

O-Ring Boss Straight Thread (SAE J514)

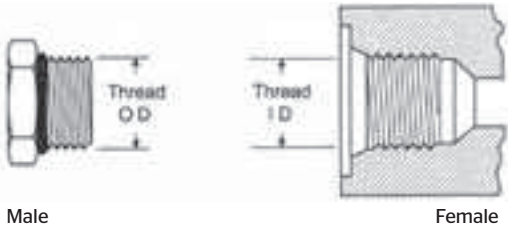

Identification

Male fitting has a straight thread and an O-ring. The female port has a straight thread and a chamfer to accept the O-ring.

Seal

The seal takes place by compressing the O-ring into the chamfer. The threads hold the connection mechanically. Only connect O-ring boss male with O-ring boss female.

Application

Recommended by the National Fluid Power Association for optimal leakage control in medium- and high-pressure hydraulic systems.

Thread Identification Table O-Ring Boss Straight Thread

Dash Size	Nominal Size	Thread Size	Female Thread ID	Male Thread OD
	in.		in.	in.
-2	1/8	5/16-24	17/64	5/16
-3	3/16	3/8-24	21/64	3/8
-4	1/4	7/16-20	25/64	7/16
-5	5/16	1/2-20	29/64	1/2
-6	3/8	9/16-18	1/2	9/16
-8	1/2	3/4-16	11/16	3/4
-10	5/8	7/8-14	13/16	7/8
-12	3/4	1 1/16 - 12	31/32	1 1/16
-14	7/8	1 3/16 - 12	1 1/64	1 3/16
-16	1	1 5/16 - 12	1 15/64	1 5/16
-20	1 1/4	1 5/8 - 12	1 35/64	1 5/8
-24	1 1/2	1 7/8 - 12	1 59/64	1 7/8
-32	2	2 1/2 - 12	2 27/64	2 1/2

O-Ring Face Seal (SAE J1453 ORS/ORFS)

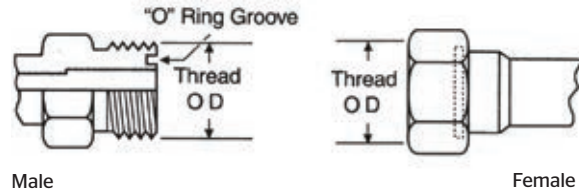

Identification

Male fitting has a straight thread and an O-ring. Female has a straight thread and a machined flat face.

Seal

The seal takes place by compressing the O-ring onto the flat face of the female. The threads hold the connection mechanically.

Application

Fittings are intended for hydraulic systems where elastomeric seals are preferred to overcome leakage and leak resistance. This connection offers the very best in leakage control.

Thread Identification Table O-Ring Face Seal (ORFS)

Dash Size	Nominal Size	Thread Size	Female Thread ID	Male Thread OD
	in.		in.	in.
-4	1/4	9/16-18	1/2	9/16
-6	3/8	11/16-16	5/8	11/16
-8	1/2	13/16-16	3/4	13/16
-10	5/8	1-14	15/16	1
-12	3/4	1 3/16 - 12	1 1/8	1 3/16
-16	1	1 7/16 - 12	1 1/2	1 7/16
-20	1 1/4	1 11/16 - 12	1 19/32	1 11/16
-24	1 1/2	2-12	1 29/32	2

Fitting Standards

North American SAE Thread Types

SAE J514 Flareless Tube Fitting

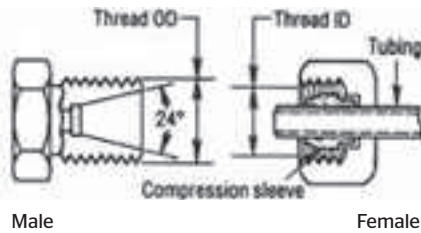

Identification

Male and female have straight threads. Male has 24° seat.

Seal

Female includes a compression sleeve for the sealing surface. A seal is formed with the compression sleeve as the female nut is tightened onto the male thread. A seal is formed between the compression sleeve, the male 24° seat and tubing.

Application

Used to adapt steel tubing to a hydraulic hose assembly.

Thread Identification Table
Flareless Tube Fitting

Dash Size	Tube Size in.	Nominal Size in.	Thread Size	Female Thread ID in.	Male Thread OD in.
-2	1/8	5/16	5/16-24	17/64	5/16
-3	3/16	3/8	3/8-24	21/64	3/8
-4	1/4	7/16	7/16-20	25/64	7/16
-5	5/16	1/2	1/2-20	29/64	1/2
-6	3/8	9/16	9/16-18	1/2	9/16
-8	1/2	3/4	3/4-16	11/16	3/4
-10	5/8	7/8	7/8-14	13/16	7/8
-12	3/4	1 1/16	1 1/16-12	31/32	1 1/16
-14	7/8	1 3/16	1 3/16-12	1 7/64	1 3/16
-16	1	1 5/16	1 5/16-12	1 15/64	1 5/16
-20	1 1/4	1 5/8	1 5/8-12	1 35/64	1 5/8
-24	1 1/2	1 7/8	1 7/8-12	1 51/64	1 7/8
-32	2	2 1/2	2 1/2-12	2 27/64	2 1/2

SAE 45° Inverted Flare (SAE J512)

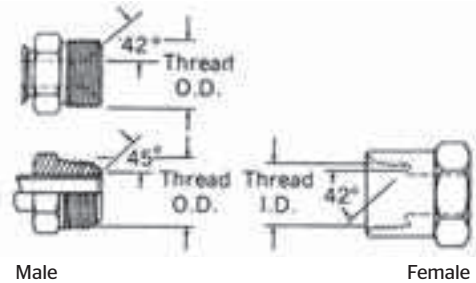

Identification

Male fitting, with a straight thread, that can either be a 45° flare as a tube fitting or a 42° seat as a machined adapter. The female has a straight thread and a 42° inverted flare.

Seal

The seal takes place on the flared surfaces. The threads hold the connection in place mechanically.

Application

This fitting is frequently used in automotive systems.

Thread Identification Table
SAE 45° Inverted Flare

Dash Size	Nominal Size in.	Thread Size	Female Thread ID in.	Male Thread OD in.
-2	1/8	5/16-28	9/32	5/16
-3	3/16	3/8-24	21/64	3/8
-4	1/4	7/16-24	25/64	7/16
-5	5/16	1/2-20	29/64	1/2
-6	3/8	5/8-18	37/64	5/8
-7	7/16	11/16-18	5/8	11/16
-8	1/2	3/4-18	45/64	3/4
-10	5/8	7/8-18	13/16	7/8
-12	3/4	1 1/16-16	1	1 1/16

Fitting Standards

North American SAE Thread Types

Code 61, Code 62, Caterpillar® Flanges (SAE J518)

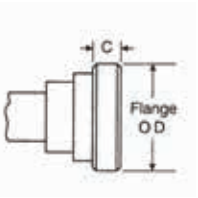

Male

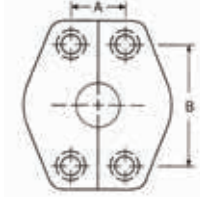

4-Bolt Split Flange

Identification

The female port is an unthreaded hole surrounded with 4 bolt holes in a rectangular pattern. The male consists of a flanged head grooved for an O-ring and a flange with holes to match the port.

Seal

The seal takes place on the O-ring, which is compressed between the flanged head and the flat surface surrounding the port. The threaded bolts hold the connection mechanically.

Application

Commonly used in fluid power systems, worldwide and usually in connection on pumps and motors. The fitting is available in two pressure ratings. Code 61, Form R, PN 35/350 bar, Type I is referred to as the "standard" series and can withstand an operating pressure of 3,000–5,000 psi depending on size. Code 62, Form S, PN 415 bar Type II is the heavy-duty, 6,000 psi series. While the design is the same, bolt hole spacing and flanged head diameters are larger for the higher pressure Code 62 fitting.

Comments

SAE J518, DIN 20066, ISO/DIS 6162 and JIS B 8363 are interchangeable except for the bolt sizes. The -10 is not available as an SAE standard size. Caterpillar® flanges, which have the same flange OD as SAE Code 62, have a thicker flange head. This is the "C" dimension in the table.

How to Measure

1. Measure port hole diameter [nominal flange size (in.)] using calipers.
2. Measure the longest bolt hole spacing from center to center, which is Dimension "B."
3. Or see the flange OD for further identification.

Thread Identification Tables

Code 61

Nominal Flange Size	Flange OD	A	B	C
in.				
1/2	1.188	0.688	1.500	0.265
5/8	1.345			0.265
3/4	1.500	0.875	1.875	0.265
1	1.750	1.031	2.062	0.315
1 ¼	2.000	1.188	2.312	0.315
1 ½	2.375	1.406	2.750	0.315
2	2.812	1.688	3.062	0.375
2 ½	3.312	2.000	3.500	0.375
3	4.000	2.438	4.188	0.375
3 ½	4.500	2.750	4.750	0.422
4	5.000	3.062	5.125	0.442
5	6.000	3.625	6.000	0.442

Code 62

Nominal Flange Size	Flange OD	A	B	C
in.				
1/2	1.250	0.718	1.594	0.305
3/4	1.625	0.937	2.000	0.345
1	1.875	1.093	2.250	0.375
1 ¼	2.125	1.250	2.625	0.405
1 ½	2.500	1.437	3.125	0.495
2	3.125	1.750	3.812	0.495

Caterpillar® Code 62

Nominal Flange Size	Flange OD	A	B	C
in.				
3/4	1.625	0.938	2.000	0.560
1	1.875	1.094	2.250	0.560
1 ¼	2.125	1.250	2.625	0.560
1 ½	2.500	1.438	3.125	0.560
2	3.125	1.750	3.812	0.560

Fitting Standards

North American SAE Thread Types

SAE J1467 Clip Fastener

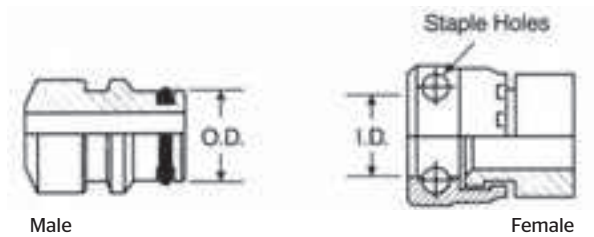

Identification

The male has an external O-ring with a groove to accept a clip. The female has a smooth bore with two holes to accept a "U" shaped clip. With the male fitting inserted into the female fitting, a clip is inserted through the two holes, locking the connection together.

Seal

The seal is formed between the O-ring on the male fitting and the smooth bore of the female fitting.

Application

Commonly used for hydraulic applications in underground mines.

Thread Identification Table
SAE J1467 Clip Fastener

Dash Size	Nominal Size	Female Thread ID	Male Thread OD
	in.	in.	in.
-4	1/4	19/32	19/32
-6	3/8	5 1/4	25/32
-8	1/2	6 1/4	15/16
-12	3/4	1 1/4	1 1/4
-16	1	1 35/64	1 1/32
-20	1 1/4	1 13/16	1 13/16
-24	1 1/2	2 11/64	2 5/32
-32	2	2 17/32	2 33/64

Fitting Standards

British Thread Types

BSPT (British Standard Pipe Tapered)

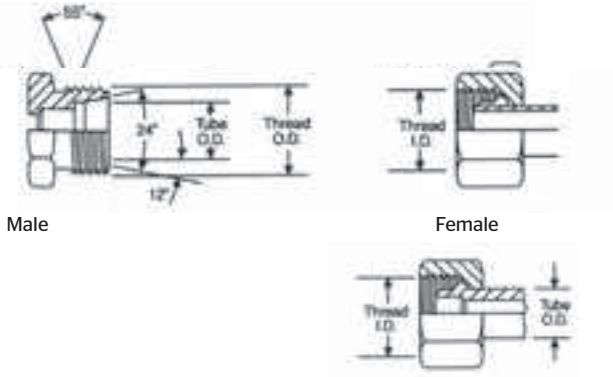

Identification

The British Standard Pipe Tapered is very similar to the NPTF fitting—a male fitting has a tapered thread. BSP threads are also known as Whitworth threads.

Seal

The BSPT male can be connected with a BSPT female or BSPP female. In either case, the seal is made within the threads through thread distortion. A thread sealant is recommended.

Comments

The BSPT fitting, although similar to the NPTF fitting, is not interchangeable. The thread pitch is different in most cases and the thread angle is 55° for the BSPT, as opposed to the 60° found on NPTF threads.

BSPP (British Standard Pipe Parallel)

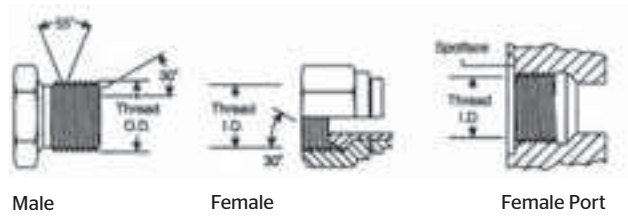

Identification

The British Standard Pipe Parallel would be similar to the NPSM fitting. BSP threads are also known as Whitworth threads.

Seal

The BSPP male will connect with the BSPP female or female port. Both male and female have a straight thread and 30° seat and chamfer. The seal takes place by compression of the 30° seat on the chamfer. The threads hold the connection mechanically.

Comments

The BSPP fitting, although similar to the NPSM fitting, is not interchangeable. The thread pitch is different in most cases and the thread angle is 55° for the BSPP, as opposed to the 60° found on NPSM threads.

Thread Identification Table

BSPT & BSPP

Dash Size	Nominal Size	Thread Size	Female Thread ID	Male Thread OD
	in.		in.	in.
-2	1/8	1/8-28	11/32	3/8
-4	1/4	1/4-19	15/32	17/32
-6	3/8	3/8-19	19/32	21/32
-8	1/2	1/2-14	3/4	13/16
-10	5/8	5/8-14	13/16	29/32
-12	3/4	3/4-14	31/32	1 1/32
-16	1	1-11	1 1/2	1 1/32
-20	1 1/4	1 1/4-11	1 17/32	1 21/32
-24	1 1/2	1 1/2-11	1 25/32	1 7/8
-32	2	2-11	2 7/32	2 1/32

Fitting Standards

French Thread Types

Millimetrique and GAZ 24°

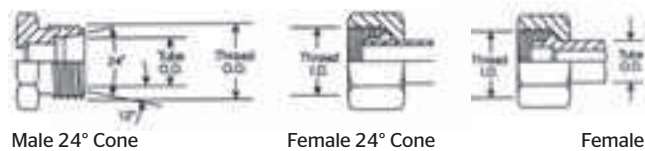

Identification

The French Metric (GAZ) fittings have a 24° seat and straight, metric threads. While similar to DIN fittings, the French use fine threads on all sizes while the DIN fitting may have a coarse thread on the larger sizes.

Seal

GAZ male with a 24° seat will mate with the female, 24° cone or the female tube fitting.

Comments

The Millimetrique Series is used with whole number metric OD tubing and the GAZ Series is used with fractional number metric OD pipe size tubing.

Thread Identification Tables

French Metric Millimetrique

Metric Thread	Female Thread ID		Male Thread OD		Tube OD	
	mm	in.	mm	in.	mm	in.
M 12 x 1	11.0	0.43	12.0	0.47	6	0.24
M 14 x 1 ½	12.5	0.49	14.0	0.55	8	0.31
M 16 x 1 ½	14.5	0.57	16.0	0.63	10	0.39
M 18 x 1 ½	16.5	0.65	18.0	0.71	12	0.47
M 20 x 1 ½	18.5	0.73	20.0	0.79	14	0.55
M 22 x 1 ½	20.5	0.81	22.0	0.87	15	0.59
M 24 x 1 ½	22.5	0.89	24.0	0.94	16	0.63
M 27 x 1 ½	25.5	1.00	27.0	1.06	18	0.71
M 30 x 1 ½	28.5	1.12	30.0	1.18	22	0.87
M 33 x 1 ½	31.5	1.24	33.0	1.30	25	0.98
M 36 x 1 ½	34.5	1.36	36.0	1.42	28	1.10
M 39 x 1 ½	37.5	1.48	39.0	1.54	30	1.18
M 42 x 1 ½	40.5	1.59	42.0	1.65	32	1.26
M 45 x 1 ½	43.5	1.71	45.0	1.77	35	1.38
M 48 x 1 ½	46.5	1.83	48.0	1.89	38	1.50
M 52 x 1 ½	50.5	1.99	52.0	2.05	40	1.57
M 54 x 2	51.9	2.04	54.0	2.13	45	1.77

French Metric GAZ 24° Cone

Dash Size	Metric Thread	Female Thread ID		Male Thread OD		Tube OD	
		mm	in.	mm	in.	mm	in.
-6	M 20 x 1.5	18.5	0.73	20.0	0.78	13.25	0.52
-8	M 24 x 1.5	22.5	0.89	24.0	0.94	16.75	0.66
-10	M 30 x 1.5	28.5	1.12	30.0	1.18	21.25	0.83
-12	M 36 x 1.5	34.5	1.36	36.0	1.41	26.75	1.05
-16	M 45 x 1.5	43.5	1.71	45.0	1.77	33.50	1.32
-20	M 52 x 1.5	50.5	1.99	52.0	2.04	42.25	1.66

GAZ Poclairn 24° Flange

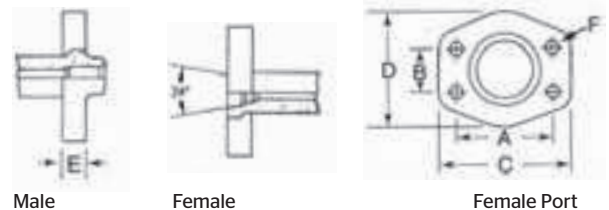

Identification

Usually found on Poclairn equipment. The Poclairn flange with a 24° seat is different from an SAE flange in that there is a lip that protrudes from the flange face.

Seal

The male flange will connect with a female flange or port. The seal is made on the 24° seat.

Thread Identification Table

GAZ Poclairn 24° Flange

Nominal Size	A	B	C	D	E	F
	in.					
1/2	1.57	0.72	2.20	1.89	0.55	0.35
5/8	1.57	0.72	2.20	1.89	0.55	0.35
3/4	2.00	0.94	2.75	2.38	0.71	0.43

Fitting Standards

German Thread Types

DIN 2353 24° Cone

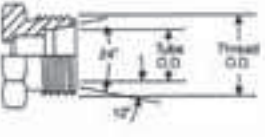

Male 24° Cone



Female 24° Cone
with O-Ring

Female Metric
Tube

Female Universal
24° or 60° Cone

Identification

Both male and female have straight metric threads. The male has a 24° seat and a recessed counter bore that matches the tube OD used with it. The female can be any of three styles including a 24° cone with an O-ring, a metric tube fitting, or a universal 24° or 60° cone. Use a 12° gauge to measure seat angle as the dimension is taken from the fitting centerline.

Seal

Sealing takes place between the 24° seat in the male end and the respective sealing area in the female end.

Comments

There is a light and heavy version of this coupling. Proper identification is made by measuring the thread size and tube OD. The heavy-duty version has a smaller tube OD than the light-duty version, but it has a thicker wall section.

Thread Identification Table

DIN 2353 24° Cone

Metric Thread	Female Thread ID		Male Thread OD		Tube OD Light Series		Tube OD Heavy Series	
	mm	in.	mm	in.	mm	in.	mm	in.
M 12 x 1 ½	10.5	0.41	12	0.47	6	0.24		
M 14 x 1 ½	12.5	0.49	14	0.55	8	0.31	6	0.24
M 16 x 1 ½	14.5	0.57	16	0.63	10	0.39	8	0.31
M 18 x 1 ½	16.5	0.65	18	0.71	12	0.47	10	0.39
M 20 x 1 ½	18.5	0.73	20	0.79			12	0.47
M 22 x 1 ½	20.5	0.81	22	0.87	15	0.59	14	0.55
M 24 x 1 ½	22.5	0.89	24	0.94			16	0.63
M 26 x 1 ½	24.5	0.96	26	1.02	18	0.71		
M 30 x 2	28.5	1.12	30	1.18	22	0.87	20	0.79
M 36 x 2	33.9	1.33	36	1.42	28	1.10	25	0.98
M 42 x 2	39.9	1.57	42	1.65			30	1.18
M 45 x 2	42.9	1.69	45	1.77	35	1.38		
M 52 x 2	49.9	1.96	52	2.05	42	1.65	38	1.50

Fitting Standards

German Thread Types

DIN 3863 60° Cone

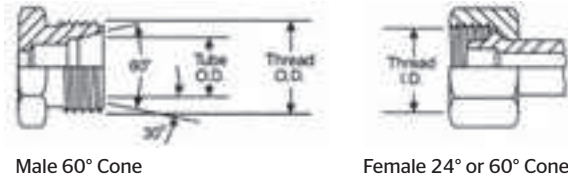

Identification

Both male and female have straight metric threads. Use a 30° gauge to measure seat angle as this dimension is taken from the fitting centerline.

Seal

The male has a 60° seat. The female has a 24° or 60° seat. The seal takes place by contact between the 60° seat in the male end and the respective sealing area in the female end.

Thread Identification Table DIN 3863 60° Cone

Metric Thread	Female Thread ID		Male Thread OD		Tube OD 60° Cone	
	mm	in.	mm	in.	mm	in.
M 12 x 1 ½	10.5	0.41	12	0.47	6	0.24
M 14 x 1 ½	12.5	0.49	14	0.55	8	0.31
M 16 x 1 ½	14.5	0.57	16	0.63	10	0.39
M 18 x 1 ½	16.5	0.65	18	0.71	12	0.47
M 22 x 1 ½	20.5	0.81	22	0.87	15	0.59
M 26 x 1 ½	24.5	0.96	26	1.02	18	0.71
M 30 x 2	28.5	1.12	30	1.18	22	0.87
M 38 x 2	36.5	1.44	38	1.50	28	1.10
M 45 x 2	43.5	1.71	45	1.77	35	1.38
M 52 x 2	50.5	1.99	52	2.05	42	1.65

DIN 3852 Types A & B

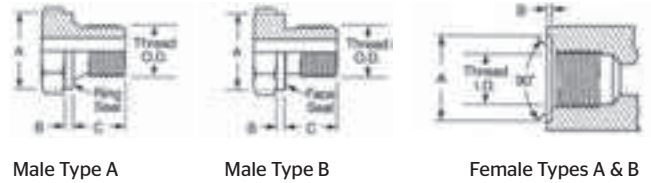

Identification

Both male and female, Type A (light-duty) and Type B (heavy-duty) have straight threads.

Seal

The seal occurs when the ring seal in Type A or the face seal in Type B connects with the face of the female port.

Thread Identification Table DIN 3852 Types A & B

Male Metric Thread Parallel

	Tube OD	Metric Thread Size	Thread OD	A	B	C
				mm	mm	mm
L Light	6	10 x 1	10	14	1.5	8
	8	12 x 1 ½	12	17	2.0	12
	10	14 x 1 ½	14	19	2.0	12
	12	16 x 1 ½	16	21	2.5	12
	15	18 x 1 ½	18	23	2.5	12
	18	22 x 1 ½	22	27	3.0	14
	22	26 x 1 ½	26	31	3.0	16
	28	33 x 2	33	39	3.0	18
	35	42 x 2	42	49	3.0	20
	42	48 x 2	48	55	3.0	22
S Heavy	6	12 x 1 ½	12	17	2.0	12
	8	14 x 1 ½	14	19	2.0	12
	10	16 x 1 ½	16	21	2.5	12
	12	18 x 1 ½	18	23	2.5	12
	14	20 x 1 ½	20	35	3.0	14
	16	22 x 1 ½	22	27	3.0	14
	20	27 x 2	27	32	3.0	16
	25	33 x 2	33	39	3.0	18
	30	42 x 2	42	49	3.0	20
	38	48 x 2	48	55	3.0	22

DIN 3852 Types A & B continue on the next page.

Fitting Standards

German Thread Types

DIN 3852 Types A & B

Thread Identification Tables Continued

Female Metric Thread Parallel

	Tube OD	Metric Thread Size	Thread ID	A	B
	mm	mm	mm	mm	mm
	6	10 x 1	8.5	15	1.0
	8	12 x 1 ½	10.5	18	1.5
	10	14 x 1 ½	12.5	20	1.5
	12	16 x 1 ½	14.5	22	1.5
L Light	15	18 x 1 ½	16.5	24	2.0
	18	22 x 1 ½	20.5	28	2.5
	22	26 x 1 ½	24.5	32	2.5
	28	33 x 2	31.5	40	2.5
	35	42 x 2	40.5	50	2.5
	42	48 x 2	46.5	56	2.5
	6	12 x 1 ½	10.5	18	1.5
	8	14 x 1 ½	12.5	20	1.5
	10	16 x 1 ½	14.5	22	1.5
	12	18 x 1 ½	16.5	24	2.0
S Heavy	14	20 x 1 ½	18.5	26	2.0
	16	22 x 1 ½	20.5	28	2.5
	20	27 x 2	25.5	33	2.5
	25	33 x 2	31.5	40	2.5
	30	42 x 2	40.5	50	2.5
	38	48 x 2	46.5	56	2.5

Female Whitworth Thread Parallel (BSPOR)

	Tube OD	Metric Thread Size	Thread ID	A	B
	mm	mm	in.	mm	mm
	6	1/8-28	11/32	15	1.0
	8	1/4-19	15/32	19	1.5
	10	1/4-19	15/32	19	1.5
	12	3/8-19	19/32	23	2.0
L Light	15	1/2-14	3/4	27	2.5
	18	1/2-14	3/4	27	2.5
	22	3/4-14	31/32	33	2.5
	28	1-11	1 ½	40	2.5
	35	1 ¼-11	1 ¾	50	2.5
	42	1 ½-11	1 ⅞	56	2.5
	6	1/4-19	15/32	19	1.5
	8	1/4-19	15/32	19	1.5
	10	3/8-19	19/32	23	2.0
	12	3/8-19	19/32	23	2.0
S Heavy	14	1/2-14	3/4	27	2.5
	16	1/2-14	3/4	27	2.5
	20	3/4-14	31/32	33	2.5
	25	1-11	1 ½	40	2.5
	30	1 ¼-11	1 ¾	50	2.5
	38	1 ½-11	1 ⅞	56	2.5

Male Whitworth Thread Parallel (BSPP)

	Tube OD	Metric Thread Size	Thread OD	A	B	C
	mm	mm	in.	mm	mm	mm
	6	1/8-28	3/8	14	1.5	8
	8	1/4-19	1/2	17	2.0	12
	10	1/4-19	1/2	19	2.0	12
	12	3/8-19	21/32	21	2.5	12
L Light	15	1/2-14	13/16	23	2.5	12
	18	1/2-14	13/16	27	3.0	14
	22	3/4-14	1 ½	31	3.0	16
	28	1-11	1 ⅝	39	3.0	18
	35	1 ¼-11	1 ⅞	49	3.0	20
	42	1 ½-11	1 ⅞	55	3.0	22

Male Whitworth Thread Parallel (BSPP)

	Tube OD	Metric Thread Size	Thread OD	A	B	C
	mm	mm	in.	mm	mm	mm
	6	1/4-19	1/2	17	2.0	12
	8	1/4-19	1/2	19	2.0	12
	10	3/8-19	21/32	21	2.5	12
	12	3/8-19	21/32	23	2.5	12
S Heavy	14	1/2-14	13/16	25	3.0	14
	16	1/2-14	13/16	27	3.0	14
	20	3/4-14	1 ½	32	3.0	16
	25	1-11	1 ⅝	39	3.0	18
	30	1 ¼-11	1 ⅞	49	3.0	20
	38	1 ½-11	1 ⅞	55	3.0	22

Fitting Standards

German Thread Types

DIN 3852 Type C

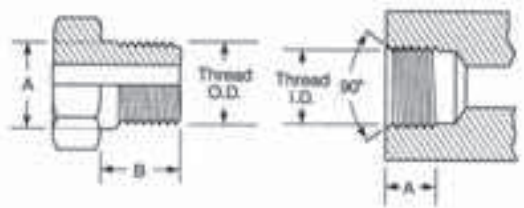

Male

Female

Identification

Both male and female have tapered threads, and both are available in metric and Whitworth threads.

Seal

The male will only connect with the female as shown. The seal takes place on the threads.

Comments

Type C couplings are available in extra light (LL), light (L) and heavy (S).

Thread Identification Tables

DIN 3852 Type C

Male Metric Tapered Threads

	Tube OD	Metric Thread Size	Thread OD	A	B
	mm	mm	mm	mm	mm
LL Extra Light	4	8 x 1	8	8.40	8
	5	8 x 1	8	8.40	8
	6	10 x 1	10	10.40	8
	8	10 x 1	10	10.40	8
L Light	6	10 x 1	10	10.40	8
	8	12 x 1 ½	12	12.53	12
	10	14 x 1 ½	14	14.53	12
	12	16 x 1 ½	16	16.53	12
	15	18 x 1 ½	18	18.53	12
	18	22 x 1 ½	22	22.65	14
S Heavy	6	12 x 1 ½	12	12.53	12
	8	14 x 1 ½	14	14.53	12
	10	16 x 1 ½	16	16.53	12
	12	18 x 1 ½	18	18.53	12
	14	20 x 1 ½	20	20.65	14
	16	22 x 1 ½	22	22.65	14

Female Metric Tapered Threads

	Tube OD	Metric Thread Size	Thread ID	A
	mm	mm	mm	mm
LL Extra Light	4	8 x 1	6.5	5.5
	5	8 x 1	6.5	5.5
	6	10 x 1	8.5	5.5
	8	10 x 1	8.5	5.5
L Light	6	10 x 1	8.5	5.5
	8	12 x 1 ½	10.5	8.5
	10	14 x 1 ½	12.5	8.5
	12	16 x 1 ½	14.5	8.5
	15	18 x 1 ½	16.5	8.5
	18	22 x 1 ½	20.5	10.5
S Heavy	6	12 x 1 ½	10.5	8.5
	8	14 x 1 ½	12.5	8.5
	10	16 x 1 ½	14.5	8.5
	12	18 x 1 ½	16.5	8.5
	14	20 x 1 ½	18.5	10.5
	16	22 x 1 ½	20.5	10.5

DIN 3852 Type C continues on the next page.

Fitting Standards

German Thread Types

DIN 3852 Type C

Thread Identification Tables Continued

Male Whitworth Tapered Threads

	Tube OD	Thread Size	Thread OD	A	B
	mm	in.	mm	in.	mm
LL Extra Light	4	1/8-28	1/8	0.392	8
	5	1/8-28	1/8	0.392	8
	6	1/8-28	1/8	0.392	8
L Light	8	1/8-28	1/8	0.392	8
	6	1/8-28	1/8	0.392	8
	8	1/4-19	1/4	0.532	12
	10	1/4-19	1/4	0.532	12
	12	3/8-19	3/8	0.670	12
S Heavy	15	1/2-14	1/2	0.839	14
	18	1/2-14	1/2	0.839	14
	6	1/4-19	1/4	0.532	12
	8	1/4-19	1/4	0.532	12
S Heavy	10	3/8-19	3/8	0.670	12
	12	3/8-19	3/8	0.670	12
	14	1/2-14	1/2	0.839	14
	16	1/2-14	1/2	0.839	14

Female Whitworth Tapered Threads

	Tube OD	Thread Size	Thread ID	A
	mm	in.	in.	mm
LL Extra Light	4	1/8-28	11/32	5.5
	5	1/8-28	11/32	5.5
	6	1/8-28	11/32	5.5
L Light	8	1/8-28	11/32	5.5
	6	1/8-28	11/32	5.5
	8	1/4-19	15/32	8.5
	10	1/4-19	15/32	8.5
	12	3/8-19	19/32	8.5
S Heavy	15	1/2-14	3/4	10.5
	18	1/2-14	3/4	10.5
	6	1/4-19	15/32	8.5
	8	1/4-19	15/32	8.5
S Heavy	10	3/8-19	19/32	8.5
	12	3/8-19	19/32	8.5
	14	1/2-14	3/4	10.5
	16	1/2-14	3/4	10.5

Standpipe Assembly

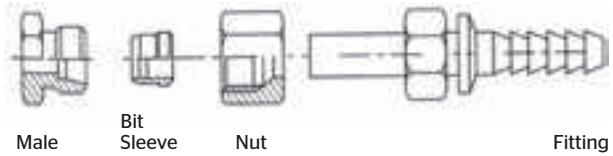

Identification

A metric standpipe is comprised of three components attached to a male fitting. The components are a standpipe, a bit sleeve and a metric nut.

Comments

The bit sleeve and standpipe are selected on the basis of tube OD. A DIN light metric nut or heavy metric nut can also be selected.

Thread Identification Table Metric Standpipe Assembly

Metric DIN Tube OD	Bit Sleeve DIN Tube OD	Metric Nut Thread	
		Light	Heavy
6	6	M 12 x 1 ½	
8	8	M 14 x 1 ½	M 16 x 1 ½
10	10	M 16 x 1 ½	M 18 x 1 ½
12	12	M 18 x 1 ½	M 20 x 1 ½
15	15	M 22 x 1 ½	
16	16		M 24 x 1 ½
18	18	M 26 x 1 ½	
20	20		M 30 x 2
22	22	M 30 x 2	
25	25		M 36 x 2
28	28	M 36 x 2	
30	30		M 42 x 2
35	35	M 45 x 2	
38	38		M 52 x 2
42	42	M 52 x 2	

Fitting Standards

German Thread Types

DIN 20066 4-Bolt Flange



Flange Head

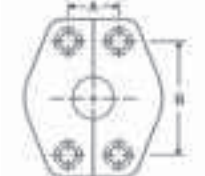

4-Bolt Split Flange

Identification

The female port is an unthreaded hole surrounded with 4 bolt holes in a rectangular pattern. The male consists of a flanged head, grooved for an O-ring, and a flange with holes to match the port.

Seal

The seal takes place on the O-ring, which is compressed between the flanged head and the flat surface surrounding the port. The threaded bolts hold the connection mechanically.

Comments

There are two pressure ratings. Form R is similar to SAE Code 61 and is referred to as the “standard” series. Form S is similar to SAE Code 62 and is referred to as the “heavy-duty” series. The design concept is the same, but bolt diameters and flange head diameters are larger for the Form S fitting. Both metric and inch bolts are used. DIN 20066 is interchangeable with both SAE J518 and JIS B 8363.

Thread Identification Tables DIN 2066 4-Bolt Flange

Form R

Nominal Flange Size	Flange OD	A	B	C
in.				
1/2	1.188	0.688	1.500	0.265
5/8	1.345			0.265
3/4	1.500	0.875	1.875	0.265
1	1.750	1.031	2.062	0.315
1 ¼	2.000	1.188	2.312	0.315
1 ½	2.375	1.406	2.750	0.315
2	2.812	1.688	3.062	0.375
2 ½	3.312	2.000	3.500	0.375
3	4.000	2.438	4.188	0.375
3 ½	4.500	2.750	4.750	0.422
4	5.000	3.062	5.125	0.442
5	6.000	3.625	6.000	0.442

Form S

Nominal Flange Size	Flange OD	A	B	C
in.				
1/2	1.250	0.718	1.594	0.305
3/4	1.625	0.937	2.000	0.345
1	1.875	1.093	2.250	0.375
1 ¼	2.125	1.250	2.625	0.405
1 ½	2.500	1.437	3.125	0.495
2	3.125	1.750	3.812	0.495

Fitting Standards

Japanese Thread Types

JIS 30° (Parallel Pipe Threads)

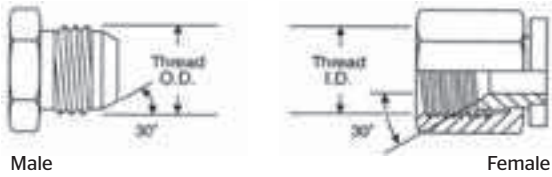

Identification

The male and female have straight threads and a 30° seat.

Seal

The JIS 30° male will only connect with the JIS 30° female. The seal is made on the 30° seat. The threads hold the connection in place mechanically.

Comments

The JIC 37° flare is very similar to the JIS 30° flare. To determine the difference, carefully measure the seat angle. The threads on the JIS 30 conform to the JIS B 0202. While the BSPP fitting has similar threads, and also has a 30° seat, the JIS 30 is not interchangeable with the BSPP fitting as the British seat is inverted.

Thread Identification Table

JIS 30° Flare Parallel

Dash Size	Nominal Size	Thread Size	Female Thread ID	Male Thread OD
	in.		in.	in.
-2	1/8	1/8-28	11/32	3/8
-4	1/4	1/4-19	7/16	17/32
-6	3/8	3/8-19	19/32	21/32
-8	1/2	1/2-14	3/4	13/16
-10	5/8	5/8-14	13/16	29/32
-12	3/4	3/4-14	15/16	1 1/32
-16	1	1-11	1 3/16	1 5/16
-20	1 1/4	1 1/4-11	1 7/32	1 21/32
-24	1 1/2	1 1/2-11	1 25/32	1 7/8
-32	2	2-11	2 1/32	2 3/32

JIS 30° Male Inverted Seat (Parallel Pipe Threads) (JIS B 0202)

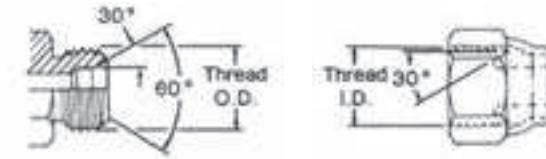

Male

Female

Identification

The JIS 30 Parallel has straight threads, conforming to JIS B 0202.

Seal

Both male and female have a straight thread and 30° seat and chamfer. The seal takes place by compression of the 30° seat on the chamfer. The threads hold the connection mechanically.

Comments

The BSPP fitting is fully interchangeable with the JIS 30 male inverted seat.

Thread Identification Table

JIS 30° Male Inverted Seat

Dash Size	Nominal Size	Thread Size	Female Thread ID	Male Thread OD
	in.		in.	in.
-4	1/4	1/4-19	15/32	8/16
-6	3/8	3/8-19	19/32	21/32
-8	1/2	1/2-14	3/4	13/16
-12	3/4	3/4-14	31/32	1 1/32
-16	1	1-11	1 7/32	1 5/16
-20	1 1/4	1 1/4-11	1 9/16	1 21/32
-24	1 1/2	1 1/2-11	1 25/32	1 7/8
-32	2	2-11	2 1/4	2 11/32

Fitting Standards

Japanese Thread Types

JIS Tapered Pipe (JIS B 0203)

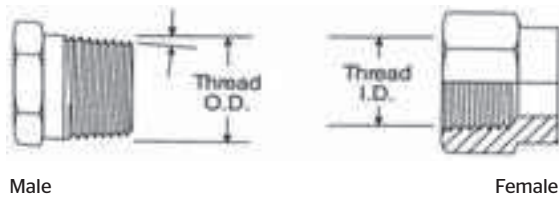

Identification

Both male and female have tapered threads that conform to JIS B 0203.

Seal

The seal is made within the threads through thread distortion. A thread sealant is recommended.

Comments

The JIS tapered pipe thread is similar to a BSPT fitting and is fully interchangeable.

Thread Identification Table JIS Tapered Pipe

Dash Size	Nominal Size	Thread Size	Female Thread ID	Male Thread OD
	in.			
-2	1/8	1/8-28	11/32	3/8
-4	1/4	1/4-19	7/16	17/32
-6	3/8	3/8-19	19/32	21/32
-8	1/2	1/2-14	3/4	13/16
-12	3/4	3/4-14	15/16	1 1/32
-16	1	1-11	1 3/16	1 3/16
-20	1 1/4	1 1/4-11	1 7/32	1 31/32
-24	1 1/2	1 1/2-11	1 29/32	1 7/8
-32	2	2-11	2 7/32	2 1/32

Komatsu® 30° Flare with Metric Threads (JIS B 0207)

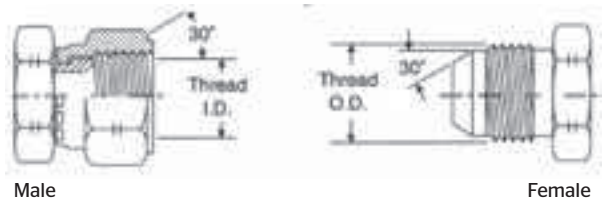

Identification

Same as JIS B 0202, but conforms to JIS B 0207 with metric threads.

Seal

Both male and female have a straight thread and 30° seat and chamfer. The seal takes place by compression of the 30° seat on the chamfer. The threads hold the connection mechanically.

Comments

Also known as the Komatsu® style, it is used extensively on Komatsu® equipment.

Thread Identification Table Komatsu® Style 30° Flare

Dash Size	Nominal Size		Metric Thread Size	Female Thread ID	Male Thread OD
	in.	mm			
-6	3/8	9.5	M 18 x 1 1/2	16.5	18
-8	1/2	13	M 22 x 1 1/2	20.5	22
-10	5/8	16	M 24 x 1 1/2	22.5	24
-12	3/4	19	M 30 x 1 1/2	28.5	30
-16	1	25	M 33 x 1 1/2	31.5	33
-20	1 1/4	32	M 36 x 1 1/2	34.5	36
-24	1 1/2	38	M 42 x 1 1/2	40.5	42

Fitting Standards

Japanese Thread Types

JIS B 8363 4-Bolt Flange

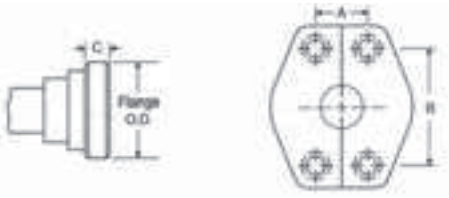

Male

Female

Identification

The female port is an unthreaded hole surrounded with 4 bolt holes in a rectangular pattern. The male consists of a flanged head, grooved for an O-ring, and a flange with holes to match the port.

Seal

The seal takes place on the O-ring, which is compressed between the flanged head and the flat surface surrounding the port. The threaded bolts hold the connection mechanically.

Comments

There are two pressure ratings. Type I is similar to SAE Code 61 and is referred to as the "standard" series. Type II is similar to SAE Code 62 and is referred to as the "heavy-duty" series. The design concept is the same, but bolt diameters and flange head diameters are larger for the Type II fitting. Both metric and inch bolts are used. JIS B 8363 is interchangeable with both SAE J518 and DIN 20066.

Thread Identification Tables JIS B 8363 4-Bolt Flange

Type I

Nominal Flange Size	Flange OD	A	B	C
in.				
1/2	1.188	0.688	1.500	0.265
5/8	1.345			0.265
3/4	1.500	0.875	1.875	0.265
1	1.750	1.031	2.062	0.315
1 ¼	2.000	1.188	2.312	0.315
1 ½	2.375	1.406	2.750	0.315
2	2.812	1.688	3.062	0.375
2 ½	3.312	2.000	3.500	0.375
3	4.000	2.438	4.188	0.375
3 ½	4.500	2.750	4.750	0.422
4	5.000	3.062	5.125	0.442
5	6.000	3.625	6.000	0.442

Type II

Nominal Flange Size	Flange OD	A	B	C
in.				
1/2	1.250	0.718	1.594	0.305
3/4	1.625	0.937	2.000	0.345
1	1.875	1.093	2.250	0.375
1 ¼	2.125	1.250	2.625	0.405
1 ½	2.500	1.437	3.125	0.495
2	3.125	1.750	3.812	0.495

Fitting Standards

Japanese Thread Types

Komatsu® Flange Fitting

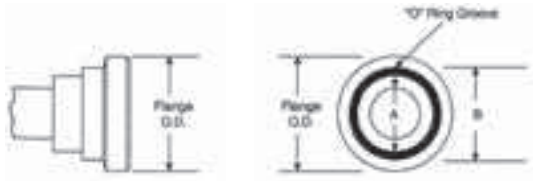

Flange

Flange Head

Identification

The Komatsu® Flange fitting is nearly identical to the SAE Code 61 flange fitting and fully interchangeable. As O-ring sizes are different, an SAE O-ring must be used when replacing the Komatsu® fitting with an SAE fitting.

Thread Identification Table
Komatsu® Style Flange

Dash Size	Nominal Size		Flange OD	A	B
	in.	mm			
-8	1/2	12.7	1.188	0.728	0.984
-10	5/8	15.9	1.345	0.728	1.102
-12	3/4	19.1	1.500	0.846	1.220
-16	1	25.4	1.750	1.122	1.496
-20	1 ¼	31.8	2.000	1.358	1.732
-24	1 ½	38.1	2.375	1.750	2.125
-32	2	50.8	2.812	2.225	2.559

Fitting Identification Templates

Male Pipe Thread Sizes

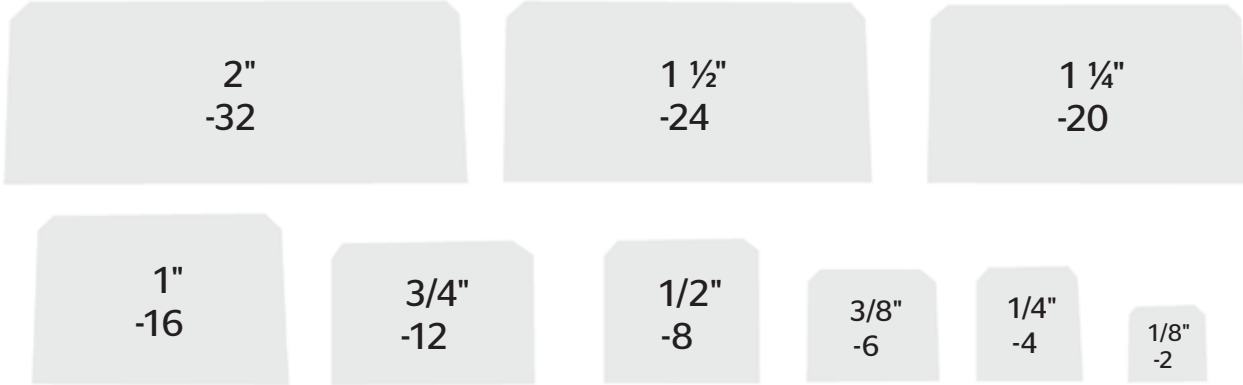

JIC 37° Flare (SAE J514) Thread Sizes

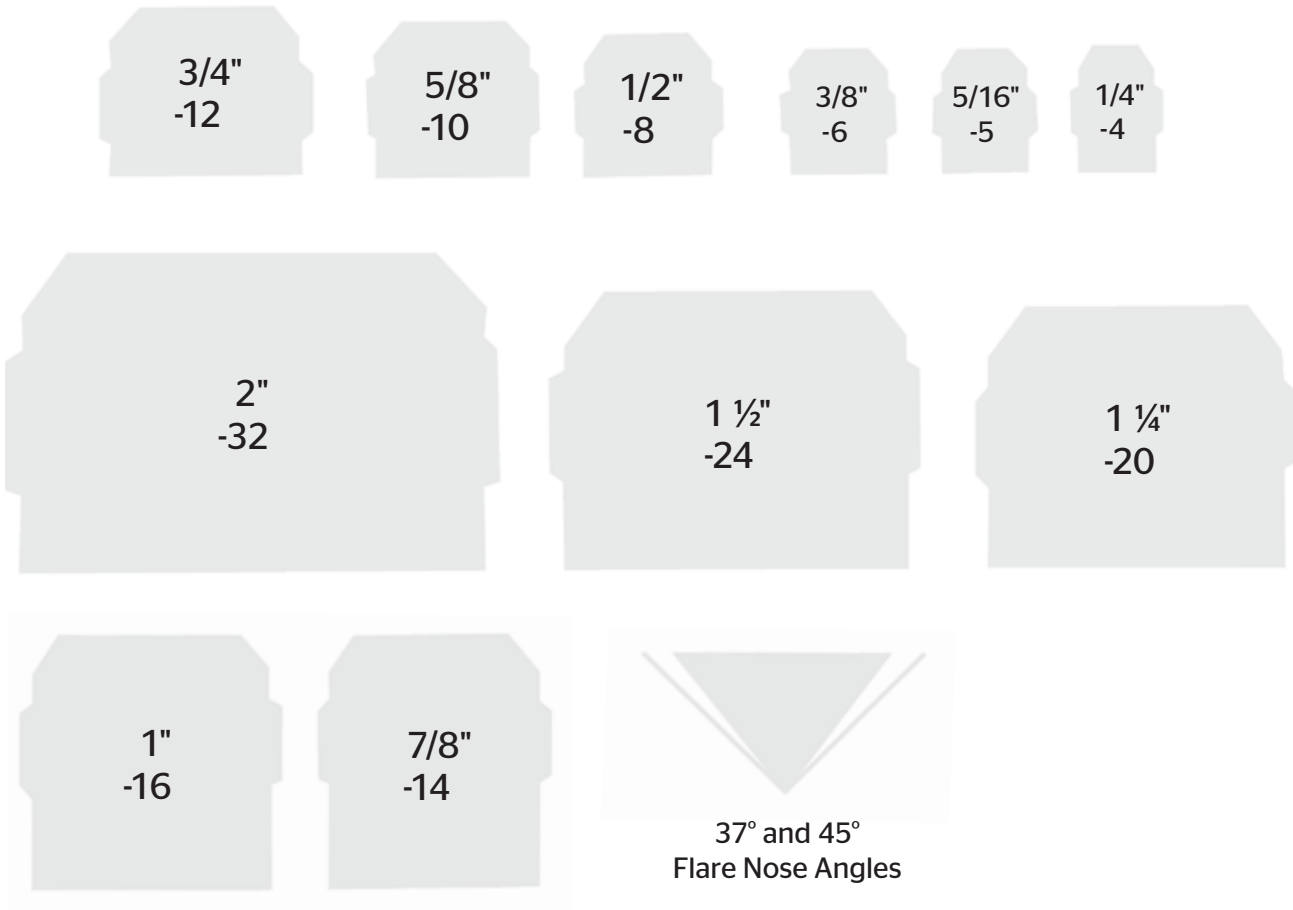

SAE 45° Flare (SAE J512) Thread Sizes



O-Ring Face Seal (SAE J1453 ORS/ORFS)

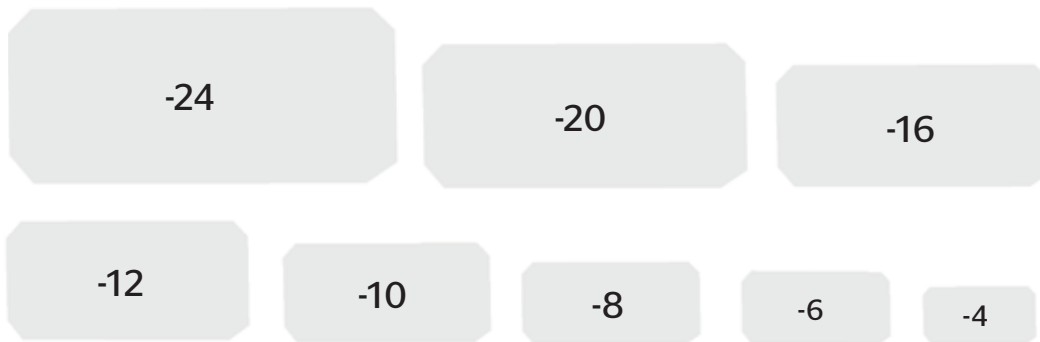

Fitting Nuts

Continental fittings can have three types of nuts: Crimp Nut, Thrust-Wire Nut and Slip-On Nut. Shown below are sample images of the three types of nuts.

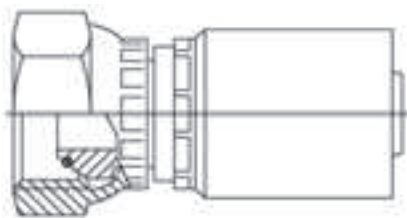

Crimp Nut

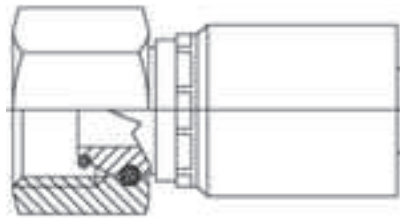

Thrust-Wire Nut

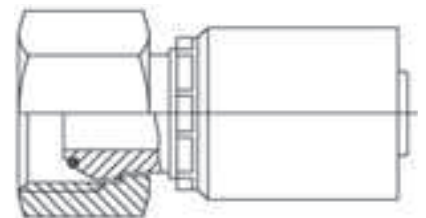

Slip-On Nut

Torque Values

O-Ring Face Seal (SAE J1453)

Dash Size	Thread Size	Swivel Nut Torque	
	in.	ft./lbs.	N/m
-4	9/16 - 18	10-12	14-16
-6	11/16 - 16	18-20	24-27
-8	13/16 - 16	32-35	43-47
-10	1 - 14	46-50	62-68
-12	1 1/8 - 12	65-70	88-95
-16	1 1/8 - 12	92-100	125-136
-20	1 1/8 - 12	125-140	170-190
-24	2 - 12	150-165	204-224

O-Ring Boss Straight Thread (SAE J514)

Dash Size	Thread Size	Jam Nut or Straight Fitting Torque	
		ft./lbs.	N/m
-3	3/8 - 24	8-9	12-13
-4	7/16 - 20	13-15	18-20
-5	1/2 - 20	14-15	19-21
-6	9/16 - 18	23-24	32-33
-8	3/4 - 16	40-43	55-57
-10	7/8 - 14	43-48	59-64
-12	1 1/8 - 12	68-75	93-101
-14	1 3/8 - 12	83-90	113-122
-16	1 3/8 - 12	112-123	152-166
-20	1 3/8 - 12	146-161	198-218
-24	1 3/8 - 12	154-170	209-230
-32	2 1/2 - 12	218-240	296-325

JIC 37° Flare (SAE J514)

Dash Size	Thread Size	Swivel Nut Torque	
	in.	ft./lbs.	N/m
-4	7/16 - 20	11-12	15-16
-5	1/2 - 20	15-16	20-22
-6	9/16 - 18	18-20	24-28
-8	3/4 - 16	38-42	52-58
-10	7/8 - 14	57-62	77-85
-12	1 1/8 - 12	79-87	108-119
-14	1 3/8 - 12	94-103	127-140
-16	1 3/8 - 12	108-113	148-154
-20	1 3/8 - 12	127-133	173-182
-24	1 3/8 - 12	158-167	216-227
-32	2 1/2 - 12	245-258	334-352

Code 61 Flange Bolt (SAE J518)

Dash Size	Port Hole ID		
	in.	ft./lbs.	N/m
-8	1/2	15-19	20-25
-12	3/4	21-29	28-40
-16	1	27-35	37-48
-20	1 1/4	35-46	48-62
-24	1 1/2	46-58	62-79
-32	2	54-66	73-90
-40	2 1/2	79-91	107-124
-48	3	137-149	186-203

Code 62 Flange Bolt (SAE J518)

Dash Size	Port Hole ID		
	in.	ft./lbs.	N/m
-8	1/2	15-19	20-25
-12	3/4	25-33	34-45
-16	1	42-50	56-68
-20	1 1/4	62-75	85-102
-24	1 1/2	116-133	158-181
-32	2	199-216	271-294

JIS 30° (BB3632000) Imperial

Dash Size	Thread Size	Swivel Nut Torque	
	in.	ft./lbs.	N/m
-4	1/4 - 19	19	25
-6	3/8 - 19	25	34
-8	1/2 - 14	49	64
-10	5/8 - 14	100	132
-12	3/4 - 14	100	132
-16	1 - 11	149	196
-20	1 ¼ - 11	171	225
-24	1 ½ - 11	194	255
-32	2 - 11	240	316

JIS 30° (BB3632000) Metric

Thread Size	Swivel Nut Torque	
mm	ft./lbs.	N/m
M 10 x 1	13-15	18-20
M 12 x 1.5	15-19	20-25
M 14 x 1.5	19-23	25-30
M 16 x 1.5	33-40	45-55
M 18 x 1.5	37-44	50-60
M 20 x 1.5	52-66	70-90
M 22 x 1.5	55-70	75-95
M 26 x 1.5	81-96	110-130
M 27 x 2	96-111	130-150
M 33 x 2	162-184	220-250
M 42 x 2	170-192	230-260
M 48 x 2	258-347	350-470

Dry NPTF (Tapered) Pipe Threads

Dash Size	Maximum Recommended Torque (Dry)	
	ft./lbs.	N/m
-2	20	25
-4	25	35
-6	35	45
-8	45	60
-12	55	75
-16	65	90
-20	80	110
-24	95	130
-32	120	160

BSPP (British Standard Pipe Parallel)

Dash Size	Thread Size	With O-Ring		Without O-Ring	
		ft./lbs.	N/m	ft./lbs.	N/m
-2	G 1/8 - 28	N/A	N/A	7	10
-4	G 1/4 - 19	15	20	15	20
-6	G 3/8 - 19	26	35	26	35
-8	G 1/2 - 14	37	50	44	60
-10	G 5/8 - 14	44	60	52	70
-12	G 3/4 - 14	63	85	85	115
-16	G 1 - 11	85	115	103	140
-20	G 1 ¼ - 11	140	190	155	210
-24	G 1 ½ - 11	177	240	214	290
-32	G 2 - 11	221	300	295	400

G= Parallel Threads

Notes

1. The torque values obtained from tightening pipe threads can vary considerably depending on thread condition. Adequate sealing can occur at values much lower than the maximum values listed above. Only enough torque to achieve adequate sealing should be used.
2. When using a male tapered pipe thread with a female straight or parallel pipe thread, maximum values are 50% of those listed in the table.
3. If thread sealant is used, maximum values shown should be decreased by 25%.

Hose ID Selection Nomograph

The chart below is intended to aid in the selection of the correct hose size. By choosing a flow rate and a flow velocity, the optimum Hose ID can be determined. Selecting the correct Hose ID is important to prevent an oversized assembly, which can be heavy and costly, or an undersized assembly that causes an excessive pressure drop.

Selecting the Correct Hose ID

1. Choose flow rate and flow velocity. Locate each value on its grid.
2. Lay a straightedge to connect the two values.
3. The recommended Hose ID is located on the ID scale, at the intersection of the line drawn between flow rate and flow velocity. Should the line intersect between two values, use the next highest ID.

Example: To find the correct Hose ID for a system running at 13 gallons/minute and 10 feet/second, draw a line between the two values on each grid. The intersection of that line on the ID grid is 3/4" ID.

Recommendations are based on a oil viscosity of 315 S.S.U., at 100°F, operating at a temperature of 65°F to 155°F.

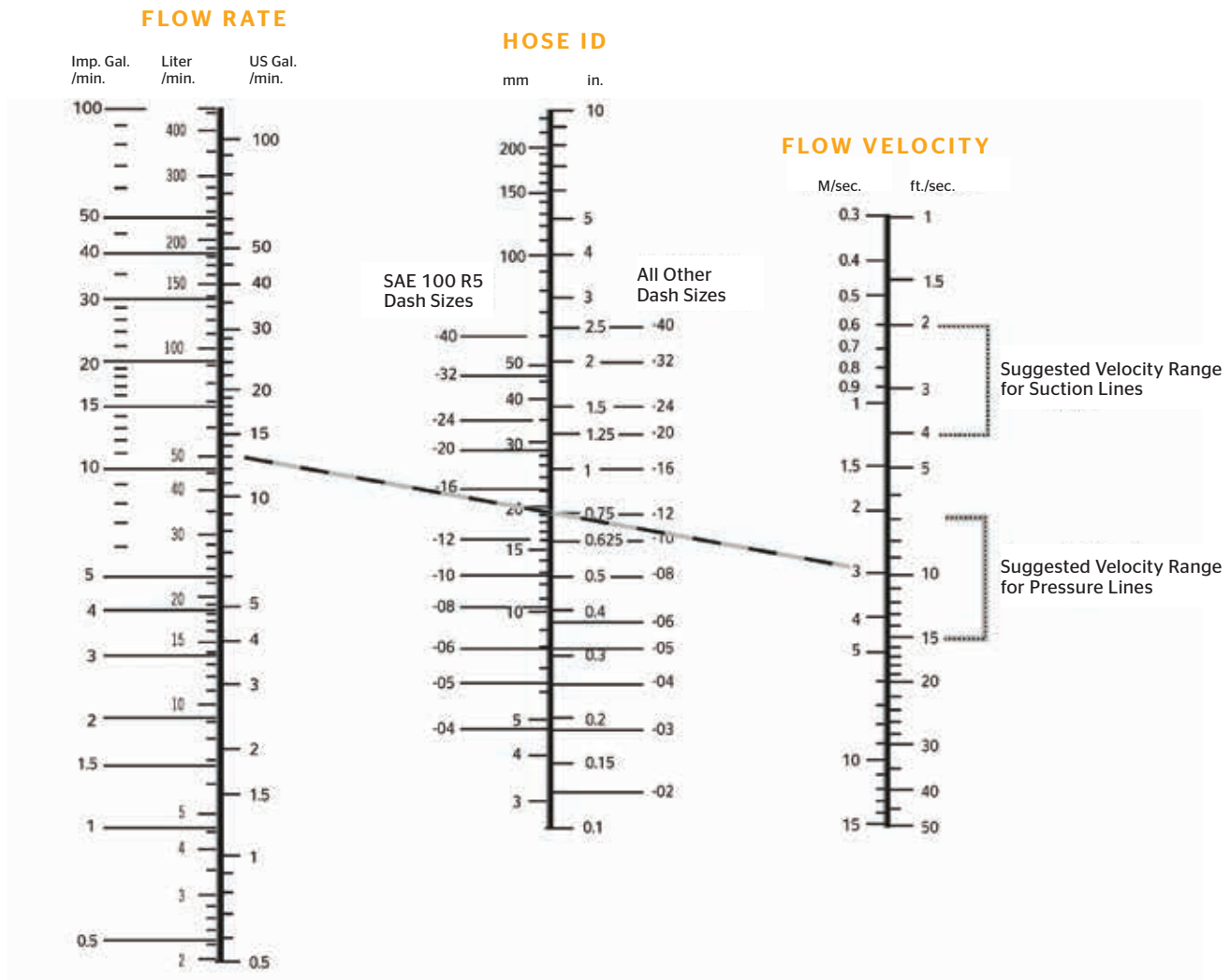

The following table represents the maximum flow rate in gallons per minute (GPM) by Hose ID for pressure lines and suction lines. The recommended maximum fluid velocity for pressure systems is 15 feet per second (FPS).

Hose ID	Recommended Maximum Flow (GPM) Pressure Lines	Recommended Maximum Flow (GPM) Suction Lines
	in.	in.
3/16	1.29	0.35
1/4	2.30	0.61
5/16	3.59	0.96
3/8	5.16	1.38
13/32	6.06	16.20
1/2	9.18	2.45
5/8	14.35	3.83
3/4	20.66	5.51
7/8	28.12	7.50
1	36.72	9.79
1 1/8	46.48	12.39
1 1/4	57.38	15.30
1 3/8	69.43	18.51
1 1/2	82.63	22.03
1 5/8	120.64	32.17
2	146.89	39.17

Use the following formulas for Velocity, Gallons per Minute or Hose ID:

V = Velocity in Feet per Second (FPS) = (.408 x GPM)/D2

GPM = Flow rate in Gallons per Minute (GPM) = V x D2/0.408

D = Hose ID (in.) = $\sqrt{\frac{0.408 \times \text{GPM}}{V}}$

The recommended maximum velocity for hydraulic systems is 15 FPS. For higher velocity, contact Continental Technical Support with specific system information.

Imperial Gallon = U.S. Gallon x 0.83267

U.S. Gallon = Imperial Gallon x 1.20095

Liter = U.S. Gallon x 3.785

U.S. Gallon = Liter x 0.2642

Hose Pressure Drop

Pressure drop is defined as the difference in input pressure and output pressure of a hose assembly. There are many factors which can contribute to pressure drop including the length of the hose assembly, the type and temperature of the fluid, the flow rate, the inside diameter of the hose and the type of couplings used.

If pressure drop is a concern, this chart can be used for a quick estimate for a hose assembly that is 10 feet long with a fluid specification of .85 specific gravity, a viscosity of 20 centistokes (97 S.S.U.) and a temperature of 100°F (38°C). Differences in fluids, fluid temperature and viscosity can increase or decrease actual pressure drop compared to the values listed.

Pressure Drop (psi)

Dash Size	-3	-4	-5	-6	-8	-10	-12	-16	-20	-24	-32	-40	-48	
Hose ID (in.)	3/16	1/4	5/16	3/8	1/2	5/8	3/4	1	1¼	1½	2	2½	3	
U.S.	0.25	10	3.1											
	0.50	19	6	2.7										
GPM	1	40	12	5.5	2.4									
	2	95	24	10	4.8									
	3	185	46	17	7	2.2								
	4		78	29	12	3	1.2							
	5		120	44	18	4.5	1.6	0.7						
	8			95	39	10	3.6	1.4						
	10				59	15	5.7	2	0.6					
	12				80	20	7.2	2.6	0.8					
	15					30	10	4.2	1.2	0.4				
	18					40	15	6.3	1.5	0.6				
	20					49	19	8	2	0.7	0.3			
	25					72	26	11	3	1	0.4			
	30						34	14	3.6	1.3	0.5	0.1		
	35						47	19	5	1.7	0.7	0.2		
	40							25	6.5	2.2	0.9	0.2		
	50							36	9	3.3	1.3	0.4	0.2	
	60							50	12	4.4	1.8	0.5	0.2	
	70								17	6	2.4	0.7	0.3	
	80								21	7.1	3	0.8	0.3	0.1
	90								27	9	3.8	1	0.5	0.1
100								33	12	4.7	1.3	0.6	0.2	
150								60	22	8.5	2.2	1	0.3	
200									36	15	3.9	1.7	0.6	
250									54	22	5.3	2.5	0.8	
300										29	7.5	4	1.1	
400										51	14	6.5	2.2	
500											20	10	3	
800												18	5	
1000													10	

Chemical Resistance Tables

The following chemical resistance tables indicate the suitability of various elastomers and metals for use with fluids being conveyed. The ratings given are intended as a guide only and not a guarantee. Ratings are for tube compound only, unless otherwise stated. The final selection of the proper hose and fitting is further dependent on many factors including temperature, concentration and length of exposure.

Hose ratings are for the impact on the polymer only. The degree of resistance of a rubber compound to a specific fluid depends on the variables of temperature, concentration and length of exposure. When in doubt or when conditions vary, contact Continental for assistance before using a specific product.

Ratings and Definitions

- E** The fluid is expected to have a minor or no effect on the hose and compound. Product may be used in continuous service. Changes in the substance, such as concentration or temperature, may impact hose product performance and cause degradation of the product.
- G** The hose and compound may be used for continuous or intermittent service, however the product properties will be impacted by the exposure to the chemical. Changes in the substance, such as concentration or temperature, may impact hose product performance and cause degradation of the product.
- X** The hose and compound should not be used with this fluid.

Blank No data is available.

WARNING: Compatibility of hose fittings with the fluid is an essential factor in avoiding chemical reactions that may result in loss of fluid or failure of the hose connection, with the potential of causing personal injury or property damage.

Chemical Resistance Tables

The following is a representative list of fluids, manufacturers and a general guideline for the use and compatibility of Continental hose and fittings.

Rating Scale

E Excellent Resistance **X** Not Recommended
G Good Resistance **-** Testing Recommended **Blank** No Data

Hose

Fittings and Adapters

Chemical Name	PTFE (Teflon®)	CR (Polychloroprene)	NBR (Nitrile)	Nitrile / PVC	CPE	CSM	Urethane	Nylon	Carbon Steel	Stainless Steel 304	Stainless Steel 316	Aluminum	Brass
Absorption Oil		G	E	G	-	G	-	-	-	-	-	-	E
Acetaldehyde	E	X	X	X	-	X	E	G	E	E	E	E	E
Acetamide	E	E	G	-	-	-	X	-	-	-	-	-	-
Acetate Solvent Crude	E												
Acetate Solvent Pure	E												
Acetic Acid, 100%	E	X	X	-	-	-	-	X	X	X	G	G	X
Acetic Acid, 100% (Hot Vapors) (to 200°F)	E	G	G	-	-	-	-	X	X	X	G	G	X
Acetic Acid, 100% Boiling		X	X	-	-	-	X	X	X	X	G	-	X
Acetic Acid, 25%		G	X	G	E	G	-	X	X	G	G	G	X
Acetic Acid, 30%	E	G	X	-	E	-	-	G	X	G	E	G	X
Acetic Acid, 50%		G	X	G	E	-	-	G	X	G	G	G	X
Acetic Acid, 50% Boiling		X	X	-	-	-	-	X	X	X	G	-	-
Acetic Acid, 5-20%		G	X	G	E	G	X	E	X	G	G	G	X
Acetic Acid, 80%		X	X	-	-	-	-	X	X	G	G	G	X
Acetic Acid, 80% Boiling		X	X	-	-	-	-	X	X	X	G	X	X
Acetic Acid, Aerated		-	-	-	-	-	-	-	X	X	X	-	X
Acetic Acid, Air Free		-	-	-	-	-	-	-	X	X	X	-	X
Acetic Acid, Anhydride	E	X	X	X	E	G	-	X	X	G	G	G	X
Acetic Acid, Crude		X	X	-	-	-	-	E	X	G	E	G	X
Acetic Acid, Glacial	E	X	X	X	E	X	X	X	X	G	G	G	-
Acetil Bromide													
Acetil Chloride													
Acetil Chromide													
Acetone (Dimethylketone)	E	X	X	X	E	X	X	E	E	E	E	E	E
Acetonitrile (Methyl Cyanide)		G	X	G	E	G	-	-	-	-	-	-	-
Acetophenone													
Acetylene	E	G	G	E	E	-	-	E	E	E	E	E	G
Acrylic Esters													
Acrylonitrile (Vinyl Cyanide)	E	X	X	X	E	X	-	-	E	E	E	G	E
Adipic Acid													
Aero Lubriplate		E	E	-	-	-	-	-	E	E	E	E	-
Aero Safe 2300		X	X	-	-	-	X	-	E	E	E	E	E
Aeroshell 17A Grease		G	E	-	-	-	X	-	E	E	E	E	-
Aeroshell 750		X	G	-	-	-	X	-	E	E	E	E	-
Aeroshell 7A Grease		G	E	-	-	-	X	-	E	E	E	E	-
Aeroshell Type 1A, 1AC, 4		G	E	-	-	-	E	-	-	-	-	-	-
Air 150°F		E	E	E	E	E	E	E	E	E	E	E	E
Air 180°F		G	G	G	E	G	G	E	E	E	E	E	E
Air 200° F		X	X	X	E	X	G	G	E	E	E	E	E
Air Ambient		E	E	E	E	E	E	E	E	E	E	E	E
Aircraft Hydr Oil AA		-	E	-	-	-	-	-	E	E	E	E	E
Alcohol	E	E	E	-	-	-	-	-	E	E	E	E	E

Underline is cover compound rating only. Many factors, such as temperature, concentration and length of exposure, are relevant to how chemical exposure impacts the tube and cover or fitting material. The fluid manufacturer's recommended maximum operating temperature should be carefully observed. Exceeding the manufacturer's recommended maximum temperature can result in fluid breakdown and cause harm or shorten the life of tube and cover materials. There may be instances where the hose cover could be adversely impacted by fluids which would not chemically impact the hose tube. Conversely, some fluids with an adverse affect on the tube of the hose may not have a deteriorating impact on the hose cover. It is recommended that the user test the hose/fluid compatibility to their own standards. Since no industry standards exist for chemical resistance, the Compass Chemical Resistance Guide for Elastomers is used whenever possible. Teflon® is a registered trademark of Dupont.

Chemical Resistance Tables

The following is a representative list of fluids, manufacturers and a general guideline for the use and compatibility of Continental hose and fittings.

Rating Scale

E Excellent Resistance **X** Not Recommended
G Good Resistance **-** Testing Recommended **Blank** No Data

Chemical Name	Hose								Fittings and Adapters				
	PTFE (Teflon®)	CR (Polychloroprene)	NBR (Nitrile)	Nitrile / PVC	CPE	CSM	Urethane	Nylon	Carbon Steel	Stainless Steel 304	Stainless Steel 316	Aluminum	Brass
Alcohol, Amyl		G	G	-	-	-	-	E	-	G	E	G	-
Alcohol, Benzyl		X	X	-	E	G	G	-	E	E	E	-	-
Alcohol, Butyl		G	X	G	-	G	E	E	E	E	E	E	E
Alcohol, Denatured		E	E	-	-	E	-	E	E	E	E	E	E
Alcohol, Diacetone		-	X	-	-	G	-	-	E	E	E	E	E
Alcohol, Ethyl (Ethanol)		E	E	E	E	E	G	E	E	E	E	E	G
Alcohol, Furfural		G	X	X	E	G	-	-	G	E	E	E	E
Alcohol, Hexyl (Hexanol)		G	E	-	-	X	-	-	E	E	E	E	G
Alcohol, Isobutyl		G	G	-	-	E	-	E	E	E	E	E	G
Alcohol, Isopropyl (Isopropanol)		G	G	G	-	G	G	E	E	E	E	E	G
Alcohol, Methyl (100%) (Methanol)		E	E	E	E	E	-	E	E	E	E	E	G
Alcohol, Methyl (6%)		E	E	E	-	E	-	E	E	E	E	E	G
Alcohol, Octyl		G	G	-	-	-	-	E	E	E	E	E	-
Alcohol, Propyl		E	E	-	-	-	-	X	G	E	E	E	E
Aliphatic (to 70°F)	E												
Alkazene		X	X	X	-	X	X	-	E	E	-	-	-
Alkyd Resins													
Aluminum Chloride	E	E	E	E	E	E	G	X	X	G	G	X	X
Aluminum Fluoride, 20%+A21	E	E	E	E	E	E	G	X	X	G	G	G	X
Aluminum Hydroxide	E	E	E	E	E	E	-	E	-	E	E	-	E
Aluminum Hydroxide, Saturated		E	E	-	-	-	-	E	-	E	E	-	-
Aluminum Nitrate	E	E	E	E	E	E	G	-	X	E	E	G	-
Aluminum Sulfate	E	E	E	E	E	E	X	E	X	X	G	X	X
Alums (Ammonium or Potassium)	E	E	E	E	E	E	-	-	X	G	G	X	X
Ammonia Gas Cold, Dry (to 175°F)													
Ammonia Gas Cold, Wet (to 480°F)													
Ammonia Liquid (Anhydrous)													
Ammonia, Aqueous	E	E	G	E	-	E	-	E	-	E	E	-	X
Ammonium Acetate	E												
Ammonium Carbonate													
Ammonium Chloride, 1%	E	X	G	E	E	E	E	E	X	G	G	X	X
Ammonium Chloride, 10% Boiling	E	X	X	-	-	-	-	X	X	G	G	X	X
Ammonium Chloride, 28% Boiling	E	X	X	-	-	-	-	X	X	G	G	X	X
Ammonium Chloride, 50% Boiling	E	X	X	-	-	-	-	X	G	E	E	-	X
Ammonium Hydroxide	E	G	G	G	E	E	X	E	G	E	E	-	X

Underline is cover compound rating only. Many factors, such as temperature, concentration and length of exposure, are relevant to how chemical exposure impacts the tube and cover or fitting material. The fluid manufacturer's recommended maximum operating temperature should be carefully observed. Exceeding the manufacturer's recommended maximum temperature can result in fluid breakdown and cause harm or shorten the life of tube and cover materials. There may be instances where the hose cover could be adversely impacted by fluids which would not chemically impact the hose tube. Conversely, some fluids with an adverse affect on the tube of the hose may not have a deteriorating impact on the hose cover. It is recommended that the user test the hose/fluid compatibility to their own standards. Since no industry standards exist for chemical resistance, the Compass Chemical Resistance Guide for Elastomers is used whenever possible. Teflon® is a registered trademark of Dupont.

Chemical Resistance Tables

The following is a representative list of fluids, manufacturers and a general guideline for the use and compatibility of Continental hose and fittings.

Rating Scale

E Excellent Resistance **X** Not Recommended
G Good Resistance **-** Testing Recommended **Blank** No Data

Chemical Name	Hose								Fittings and Adapters				
	PTFE (Teflon®)	CR (Polychloroprene)	NBR (Nitrile)	Nitrile / PVC	CPE	CSM	Urethane	Nylon	Carbon Steel	Stainless Steel 304	Stainless Steel 316	Aluminum	Brass
Ammonium Hydroxide, 3 Molar		E	X	-	-	-	G	-	X	G	G	X	X
Ammonium Hydroxide Concentrated		E	X	-	E	-	X	E	X	G	G	X	X
Ammonium Metaphosphate	E	G	G	G	-	G	-	-	E	E	E	X	-
Ammonium Nitrate, Fertilizer	E	E	G	E	E	E	E	X	E	E	E	G	X
Ammonium Nitrite		-	-	-	-	-	-	E	G	E	E	X	-
Ammonium Persulfate		X	X	X	E	-	X	X	X	G	G	X	X
Ammonium Persulfate 10%		E	X	-	-	-	X	X	X	G	G	X	X
Ammonium Persulfate 5%		E	X	-	-	-	-	X		G	G	X	X
Ammonium Phosphate (Mono, Di, Tri, Basic)	E	E	E	E	E	E	E	G	X	G	G	X	-
Ammonium Sulfate	E	E	G	E	E	E	E	X	X	X	G	X	X
Ammonium Sulfide	E	E	E	E	-	E	-	E	E	E	E	E	G
Ammonium Thiocyanate	E	E	E	-	E	E	-	-	E	E	E	-	-
Amyl Chloride	E	X	-	X	G	X	-	G	-	E	E	-	-
Amyl Chloronaphthalene	E	X	X	X	-	X	-	-	-	E	E	-	-
Amyl Naphthalene	E	X	X	X	-	X	-	-	-	E	E	-	-
Amyl Phenol		-	-	-	-	-	-	-	-	E	E	-	-
Amyl Acetate	E	X	X	X	G	X	G	E	X	E	E	X	G
Amyl Alcohol	E	E	E	E	E	E	G	X	X	G	G	G	X
Amyl Borate		G	G	G	-	-	-	-	-	-	-	-	-
AN-0-3 Grade M		E	E	-	-	-	-	-	-	-	-	-	-
AN-0-366		E	E	-	-	-	-	-	-	-	-	-	-
AN-0-6		E	E	-	-	-	-	-	-	-	-	-	-
Anderol, L-774 (Diester)		X	G	-	-	-	-	X	-	-	-	-	-
Anderol, L-826 (Diester)		X	G	-	-	-	-	X	-	-	-	-	-
Anderol, L-829 (Diester)		X	G	-	-	-	-	X	-	-	-	-	-
ANG-25 (Diester Base,TG749)		X	G	-	-	-	-	X	E	E	E	E	-
ANG-25 (Glyceral Ester)		G	G	-	-	-	-	G	-	-	-	-	-
Aniline	E	X	X	X	G	X	X	G	G	E	E	X	X
Aniline Dyes	E												
Animal Fat	E												
Animal Gelatin		E	E	-	E	-	-	-	-	E	E	-	-
Animal Oil (Lard Oil)	E	G	E	-	E	-	-	-	E	E	E	E	-
Antifreeze, Alcohol Base		G	G	G	G	G	-	-	E	E	E	E	-
Antifreeze, Glycol Base	E	G	E	E	E	E	-	E	E	E	E	E	E
Antimony Chloride, 50% (to 70°F)	E	-	E	-	-	-	-	X	X	X	X	-	-
AN-VV-0-366B Hydraulic Fluid		E	-	-	-	-	-	G	-	-	-	-	-
Aqua Regia (Concentrated)	E	X	X	X	G	X	X	X	X	X	X	X	-
Arco A.T.F. Dexron		-	E	-	-	-	-	-	-	-	-	-	-
Arco C2, 100		-	E	-	-	-	-	-	-	-	-	-	-

Underline is cover compound rating only. Many factors, such as temperature, concentration and length of exposure, are relevant to how chemical exposure impacts the tube and cover or fitting material. The fluid manufacturer's recommended maximum operating temperature should be carefully observed. Exceeding the manufacturer's recommended maximum temperature can result in fluid breakdown and cause harm or shorten the life of tube and cover materials. There may be instances where the hose cover could be adversely impacted by fluids which would not chemically impact the hose tube. Conversely, some fluids with an adverse affect on the tube of the hose may not have a deteriorating impact on the hose cover. It is recommended that the user test the hose/fluid compatibility to their own standards. Since no industry standards exist for chemical resistance, the Compass Chemical Resistance Guide for Elastomers is used whenever possible. Teflon® is a registered trademark of Dupont.

Chemical Resistance Tables

The following is a representative list of fluids, manufacturers and a general guideline for the use and compatibility of Continental hose and fittings.

Rating Scale

E Excellent Resistance **X** Not Recommended
G Good Resistance **-** Testing Recommended **Blank** No Data

Chemical Name	Hose								Fittings and Adapters				
	PTFE (Teflon®)	CR (Polychloroprene)	NBR (Nitrile)	Nitrile / PVC	CPE	CSM	Urethane	Nylon	Carbon Steel	Stainless Steel 304	Stainless Steel 316	Aluminum	Brass
Argon Gas	E												
Aromatic Fuel 30%, Mil		-	-	-	-	-	-	-	-	-	-	-	-
Aromatic Fuel 50%		X	G	-	-	-	-	-	-	-	-	-	-
Aromatic Hydrocarbons	E	X	X	-	-	X	G	-	G	E	G	G	G
Arsenic Salt (to 70°F)	E												
Askarel, Transformer Oil	-	X	X	X	-	X	-	-	E	E	E	-	E
Asphalt, Cut Back (Including Emulsions)	E	X	G	G	-	X	E	E	E	E	E	G	G
Asphalt, Topping (Including Emulsions)	E	E	X	-	-	-	-	-	E	E	E	-	-
Asphalt, Under 180°F (Including Emulsions)	E	G	G	G	X	X	E	-	E	E	E	-	G
ASTM Oil N° 1	E	E	E	E	E	G	E	E	E	E	E	E	E
ASTM Oil N° 2	E	G	E	-	G	-	E	E	E	E	E	E	E
ASTM Oil N° 3	E	X	E	X	X	X	-	E	E	E	E	E	E
ASTM Oil N° 4	E	X	G	-	-	-	-	-	E	E	E	E	-
ASTM Reference Fuel A (to 300°F)	E	G	E	E	E	E	-	E	E	E	E	E	E
ASTM Reference Fuel B (to 300°F)	E	G	E	G	G	X	-	-	E	E	E	E	E
ASTM Reference Fuel C (to 300°F)	E	X	G	X	G	X	-	-	E	E	E	-	E
ATL-857		X	G	-	-	-	-	-	-	-	-	-	-
Atlantic Dominion F		G	E	-	-	-	-	-	-	-	-	-	-
Aurex 903R (Mobil)		G	E	-	-	-	-	-	-	-	-	-	-
Automatic Brake Fluid		G	X	-	-	-	-	-	E	E	E	E	-
Automatic Transmission Fluid		G	E	-	E	-	-	-	E	E	E	E	-
Aviation Gasoline, Mil		-	G	-	-	-	-	-	E	E	E	E	-
Baltic Types 100, 150, 200, 300, 500		-	E	-	-	-	-	-	-	-	-	-	-
Banvel Concentrated (Ag Spray)		-	-	-	-	-	-	E	-	-	E	-	-
Bardol B		X	X	X	-	X	-	-	E	E	E	-	-
Barium Chloride	E	X	E	E	E	E	E	E	X	G	G	X	E
Barium Chloride, 5%	E	X	E	-	-	-	-	X	G	E	E	X	G
Barium Chloride, Aqueous Solution (Hot)		X	E	-	-	-	-	X	G	G	G	X	-
Barium Concentrate		E	E	E	E	E	-	E	G	E	E	X	-
Barium Hydroxide	E	E	E	E	E	E	X	E	X	E	E	X	X
Barium Sulfate	E	E	E	-	E	G	-	E	G	E	E	G	G
Barium Sulfate, Aqueous Solution (Hot)	E	X	-	-	-	-	-	X	G	E	E	G	X
Barium Sulfide	E	G	E	E	E	E	-	G	X	E	E	X	-
Baygon													-
Bayol 35		-	E	-	-	-	-	-	-	-	-	-	-

Underline is cover compound rating only. Many factors, such as temperature, concentration and length of exposure, are relevant to how chemical exposure impacts the tube and cover or fitting material. The fluid manufacturer's recommended maximum operating temperature should be carefully observed. Exceeding the manufacturer's recommended maximum temperature can result in fluid breakdown and cause harm or shorten the life of tube and cover materials. There may be instances where the hose cover could be adversely impacted by fluids which would not chemically impact the hose tube. Conversely, some fluids with an adverse affect on the tube of the hose may not have a deteriorating impact on the hose cover. It is recommended that the user test the hose/fluid compatibility to their own standards. Since no industry standards exist for chemical resistance, the Compass Chemical Resistance Guide for Elastomers is used whenever possible. Teflon® is a registered trademark of Dupont.

Chemical Resistance Tables

The following is a representative list of fluids, manufacturers and a general guideline for the use and compatibility of Continental hose and fittings.

Rating Scale

E Excellent Resistance **X** Not Recommended
G Good Resistance **-** Testing Recommended **Blank** No Data

Hose

Fittings and Adapters

Chemical Name	Hose								Fittings and Adapters				
	PTFE (Teflon®)	CR (Polychloroprene)	NBR (Nitrile)	Nitrile / PVC	CPE	CSM	Urethane	Nylon	Carbon Steel	Stainless Steel 304	Stainless Steel 316	Aluminum	Brass
Bayol D		-	E	-	-	-	-	-	-	-	-	-	X
Beer	E												-
Beet Sugar Liquors	E	X	E	E	E	E	X	-	G	G	G	G	E
Bellows 80-20 Hydraulic Oil		-	E	-	-	-	G	-	-	-	-	-	E
Benzaldehyde	E	X	X	X	G	X	E	E	E	E	E	E	E
Benzene, Benzo	E	X	X	X	X	X	G	E	E	E	E	E	-
Benzine, Petroleum Ether		X	G	X	E	-	G	-	E	E	E	E	X
Benzine, Petroleum Naphtha	E												E
Benzoic Acid													G
Benzyl Alcohol	E												X
Black Point 77		-	E	-	-	-	-	-	-	-	-	-	X
Black Sulfate Liquor	E	G	G	G	G	G	-	E	G	E	E	X	-
Blast Furnace Gas	E	X	X	X	-	X	X	-	E	E	E	G	E
Borax, Sodium Borate	E	X	G	G	E	E	E	X	G	E	E	X	E
Bordeaux Mixture	E	G	G	G	-	-	E	E	X	-	E	E	-
Boric Acid	E	E	E	E	-	E	E	X	X	G	G	E	-
Boron Fuels, HEF		X	X	-	-	-	-	-	-	-	-	-	-
Brake Fluid, Petroleum Base (to 300°F)	E	G	E	G	E	X	-	-	E	E	E	-	-
Brake Fluid, Synthetic Base		X	X	X	E	X	-	-	E	E	E	E	-
Bray GG-130		X	G	-	-	-	-	-	-	-	-	-	-
Brayco 719-R (VV-H-910)		G	X	-	-	-	-	-	-	-	-	-	E
Brayco 885 (MIL-L-6085A)		X	G	-	-	-	-	-	-	-	-	-	-
Brayco 910		G	G	-	-	-	-	-	-	-	-	-	E
Brine	E												E
Brom-113		X	G	-	-	-	-	-	-	-	-	-	-
Brom-114		G	G	-	-	-	-	-	-	-	-	-	X
Bromine (Permeable)	E												X
Bunker Oil	E	X	G	G	-	X	G	-	E	E	E	E	X
Butane	E	X	X	X	-	X	X	X	X	-	-	-	E
Butanone, MEK													-
Butyl Acetate	E	X	X	X	G	X	-	-	G	E	E	E	X
Butyl Acetate	E												G
Butyl Alcohol, Butanol	E												X
Butyl Cellosolve	E												X
Butyl Stearate	E												X
Butylene (Permeable)	E												X
Butyraldehyde	E												X
Cadmium Salts (to 70°F)	E												
Calcium Acetate	E	X	X	X	E	X	-	-	G	G	G	X	E
Calcium Arsenate		-	-	-	-	-	E	E	-	-	-	-	E
Calcium Bisulfate	E	E	E	G	E	E	-	-	-	G	E	-	E
Calcium Bisulfide	E	E	E	G	E	E	E	-	-	G	G	X	-

Underline is cover compound rating only. Many factors, such as temperature, concentration and length of exposure, are relevant to how chemical exposure impacts the tube and cover or fitting material. The fluid manufacturer's recommended maximum operating temperature should be carefully observed. Exceeding the manufacturer's recommended maximum temperature can result in fluid breakdown and cause harm or shorten the life of tube and cover materials. There may be instances where the hose cover could be adversely impacted by fluids which would not chemically impact the hose tube. Conversely, some fluids with an adverse affect on the tube of the hose may not have a deteriorating impact on the hose cover. It is recommended that the user test the hose/fluid compatibility to their own standards. Since no industry standards exist for chemical resistance, the Compass Chemical Resistance Guide for Elastomers is used whenever possible. Teflon® is a registered trademark of Dupont.

Chemical Resistance Tables

The following is a representative list of fluids, manufacturers and a general guideline for the use and compatibility of Continental hose and fittings.

Rating Scale

E Excellent Resistance **X** Not Recommended
G Good Resistance **-** Testing Recommended **Blank** No Data

Chemical Name	Hose								Fittings and Adapters				
	PTFE (Teflon®)	CR (Polychloroprene)	NBR (Nitrile)	Nitrile / PVC	CPE	CSM	Urethane	Nylon	Carbon Steel	Stainless Steel 304	Stainless Steel 316	Aluminum	Brass
Calcium Bisulfite	E	E	E	E	E	E	-	E	X	E	E	E	G
Calcium Carbonate	E	E	E	E	E	E	E	E	G	E	E	X	X
Calcium Chlorate	E	E	E	E	-	E	-	-	G	G	E	E	E
Calcium Chloride	E	E	E	E	E	E	E	E	X	G	G	X	E
Calcium Hydroxide	E	E	G	G	E	E	X	-	X	X	E	-	X
Calcium Hydroxide, 10% Boiling		-	G	-	-	-	-	X	G	E	E	X	E
Calcium Hydroxide, 20% Boiling		-	-	-	-	-	-	X	-	E	E	X	-
Calcium Hydroxide, 50% Boiling		-	-	-	-	-	-	X	-	X	G	X	G
Calcium Hypochlorite, 15% (Under 100°F)	E	X	-	X	E	G	-	X	-	X	G	X	X
Calcium Hypochlorite, 5% (Under 100°F)	E	X	G	X	E	G	-	X	X	X	G	X	E
Calcium Nitrate	E	E	E	E	E	E	-	E	X	G	G	X	X
Calcium Salts (to 70°F)	E												
Calcium Silicate	E	-	G	-	E	G	-	-	E	E	E	E	X
Calcium Sulfate	E	E	E	E	E	E	-	-	G	E	E	G	-
Calcium Sulfide	E	E	G	-	E	-	-	G	G	E	E	G	X
Caliche Liquors E	E												
Cane Sugar Liquors	E	E	E	G	E	E	E	-	E	E	E	E	G
Carbitol													
Carbolic Acid, Phenol	E	X	X	X	E	X	X	X	X	E	E	G	X
Carbon Bisulfide	E												
Carbon Dioxide, Dry	E	G	E	E	E	E	E	-	E	E	E	E	E
Carbon Dioxide, Wet	E	G	E	E	E	E	-	-	E	E	E	E	E
Carbon Disulfide	-	X	X	-	-	X	G	E	G	E	E	G	-
Carbon Monoxide, (Under 150°F) (Hot)	E	G	G	G	E	E	-	G	E	E	E	E	-
Carbon Tetrachloride, 5-10%	E	-	-	-	-	-	-	-	-	X	-	-	X
Carbon Tetrachloride, Pure	E	X	X	X	G	X	X	X	X	X	G	G	-
Carbonic Acid	E	E	E	E	E	E	X	-	X	E	E	G	-
Castor Oil	E	G	G	G	E	G	G	E	G	E	E	E	G
Caustic Soda, 20%	E	G	X	X	E	E	X	G	G	E	E	X	E
Caustic Soda, 50%	E	G	X	X	E	E	X	G	G	E	E	X	E
Cellosolve Acetate, Under 100°F	E	X	X	X	G	X	-	-	G	G	G	E	E
Cellosolve Butyl, Under 100°F	E	X	X	X	-	X	-	-	G	G	G	G	E
Cellosolve Union Carbide, Under 100°F	E	X	X	-	-	-	-	-	G	G	G	G	-
Cellugard, Cellugard 200		E	E	-	-	-	-	-	-	X	X	-	X
Cellulube 1000, 220A, ST220, A60 (to 70°F)	E	X	X	X	-	X	-	-	E	E	E	E	X

Underline is cover compound rating only. Many factors, such as temperature, concentration and length of exposure, are relevant to how chemical exposure impacts the tube and cover or fitting material. The fluid manufacturer's recommended maximum operating temperature should be carefully observed. Exceeding the manufacturer's recommended maximum temperature can result in fluid breakdown and cause harm or shorten the life of tube and cover materials. There may be instances where the hose cover could be adversely impacted by fluids which would not chemically impact the hose tube. Conversely, some fluids with an adverse affect on the tube of the hose may not have a deteriorating impact on the hose cover. It is recommended that the user test the hose/fluid compatibility to their own standards. Since no industry standards exist for chemical resistance, the Compass Chemical Resistance Guide for Elastomers is used whenever possible. Teflon® is a registered trademark of Dupont.

Chemical Resistance Tables

The following is a representative list of fluids, manufacturers and a general guideline for the use and compatibility of Continental hose and fittings.

Rating Scale

E Excellent Resistance **X** Not Recommended
G Good Resistance **-** Testing Recommended **Blank** No Data

Chemical Name	Hose								Fittings and Adapters				
	PTFE (Teflon®)	CR (Polychloroprene)	NBR (Nitrile)	Nitrile / PVC	CPE	CSM	Urethane	Nylon	Carbon Steel	Stainless Steel 304	Stainless Steel 316	Aluminum	Brass
Cellulube 90, 150, 220, 300, 551 (to 70°F)	E	X	X	X	-	X	-	-	E	E	E	E	X
Cellutherm 2505A	-	X	G	-	-	-	-	-	-	-	-	-	X
Chevron FR-10,13, 20, 8													
China Wood Oil (Tung)	E												
Chlor Acetone													
Chlordane (to 70°F)	E	X	X	X	-	X	-	E	-	-	-	X	X
Chlorinated Paraffin													
Chlorinated Solvents - Dry (to 212°F)	E												
Chlorinated Solvents - Wet (to 70°F)	E												
Chlorine Gas, (Under 212°F)		-	X	-	-	-	-	-	-	X	X	-	-
Chlorine Trifluoride (to 70°F)	E	X	X	-	-	-	-	-	E	E	E	E	-
Chlorine Water, 25% Chlorine		X	X	X	-	G	G	X	-	X	X	-	E
Chloroacetic Acid (Under 100°F)	E	X	X	X	-	G	-	X	X	X	X	X	E
Chlorobenzene	E	X	X	X	X	X	-	X	G	G	G	X	E
Chlorobromo Methane	E	X	X	X	-	X	-	-	G	G	G	X	G
Chloroform	E	X	X	X	X	X	-	X	G	E	E	X	X
Chlorosulphonic Acid	E												
Chlorotoluene	E	X	X	X	X	X	X	-	G	G	G	X	X
Chlorox, Bleach		G	G	-	E	G	-	E	X	G	E	X	X
Chromic Acid, 10%	E	X	X	X	E	G	X	X	X	X	G	X	X
Chromic Acid, 100%	E	-	-	-	-	-	X	-	X	X	X	X	X
Chromic Acid, 25%	E	X	X	X	E	G	X	X	X	X	G	X	X
Chromic Acid, 5%	E	X	X	-	-	-	-	X	X	G	E	X	X
Chromic Acid, 50%	E	X	X	X	E	G	X	X	X	X	X	X	X
Chromium Potassium Sulfate													
Cider													
Circo Light Process Oil		E	E	-	-	-	-	-	E	E	E	E	-
Citgo FR Fluids		-	X	-	-	-	G	-	-	-	-	-	-
Citgo FR15, 20,25													
Citgo Glycol FR-20XD		-	E	-	-	-	G	-	E	E	E	E	E
Citgo Pacemaker FR													
Citgo Pacemaker Glycol													
Citgo Sentry, (Under 100°F)		G	G	E	-	X	G	-	E	E	E	-	E
Citgo Tractor Hydraulic Fluid		-	E	-	-	-	G	-	E	E	E	-	E
Citric Acid, 15%		E	G	-	-	-	-	E	X	E	E	-	X
Citric Acid, 15% Boiling		E	G	-	-	-	-	X	X	G	E	X	X

Underline is cover compound rating only. Many factors, such as temperature, concentration and length of exposure, are relevant to how chemical exposure impacts the tube and cover or fitting material. The fluid manufacturer's recommended maximum operating temperature should be carefully observed. Exceeding the manufacturer's recommended maximum temperature can result in fluid breakdown and cause harm or shorten the life of tube and cover materials. There may be instances where the hose cover could be adversely impacted by fluids which would not chemically impact the hose tube. Conversely, some fluids with an adverse affect on the tube of the hose may not have a deteriorating impact on the hose cover. It is recommended that the user test the hose/fluid compatibility to their own standards. Since no industry standards exist for chemical resistance, the Compass Chemical Resistance Guide for Elastomers is used whenever possible. Teflon® is a registered trademark of Dupont.

Chemical Resistance Tables

The following is a representative list of fluids, manufacturers and a general guideline for the use and compatibility of Continental hose and fittings.

Rating Scale

E Excellent Resistance **X** Not Recommended
G Good Resistance **-** Testing Recommended **Blank** No Data

Chemical Name	Hose								Fittings and Adapters				
	PTFE (Teflon®)	CR (Polychloroprene)	NBR (Nitrile)	Nitrile / PVC	CPE	CSM	Urethane	Nylon	Carbon Steel	Stainless Steel 304	Stainless Steel 316	Aluminum	Brass
Citric Acid, 5%		-	G	-	-	-	-	E	X	E	E	E	X
Citric Acid, 5% @150°F		-	G	-	-	-	-	X	X	E	E	G	X
Citric Acid, Concentrated Boiling		E	X	E	-	E	G	X	X	X	G	X	X
Coal Gas		E	X	-	E	-	E	-	-	-	-	-	-
Coal Tars		X	G	X	G	G	-	-	E	E	E	E	E
Codor 1000, 1002, 1004, 1006, 1008		-	G	-	-	-	-	-	-	-	-	-	-
Coke Oven Gas (Under 100°F)	E	X	G	X	-	G	-	-	E	E	E	G	-
Conor 1008, 1010, 1012, 1014, 1016		-	G	-	-	-	-	-	-	-	-	-	-
Convelex 10		X	X	-	-	-	-	-	-	-	-	-	-
Copper Arsenate, Cupric Arsenate		-	-	-	-	G	-	-	E	E	E	-	-
Copper Chloride, 1%		E	E	-	-	-	-	X	-	G	G	-	-
Copper Chloride, 5%	E	E	E	-	-	-	-	X	-	X	G	-	-
Copper Chloride, Cupric Chloride	E	G	G	G	G	G	E	G	X	X	E	-	X
Copper Cyanide, Cupric Cyanide	E	G	G	G	-	G	-	X	E	E	E	-	X
Copper Nitrate, 1% & 5%	E	E	E	-	-	-	-	E	X	E	E	X	X
Copper Nitrate, Cupric Nitrate		E	E	E	E	E	-	-	X	E	E	-	X
Copper Sulfate, 10%	E	E	E	-	-	-	-	-	X	G	G	X	-
Copper Sulfate, 50%	E	E	E	-	-	-	-	-	-	G	G	-	-
Copper Sulfate, Cupric Sulfate		E	E	E	E	E	E	E	X	E	E	X	X
Corn Oil	E	X	G	G	G	X	X	-	E	E	E	E	E
Cosmolubric													
Cottonseed Oil	E	G	G	E	G	G	X	G	E	E	E	E	E
Creosol	E												
Creosote, Wood or Coal Tar (Under 100°F)	E	X	G	X	-	X	X	X	G	E	E	E	X
Cresol, Cresylic Acid (Under 100°F)	E	X	X	X	E	X	-	X	G	E	E	G	-
Crude Petroleum Oil	E	X	X	G	G	G	G	-	E	E	E	E	E
Cutting Oil	E	G	E	G	E	X	-	-	E	E	E	-	E
Cutting Oil, Sulfur Base	E	X	E	-	-	-	-	-	E	E	E	E	-
Cutting Oil, Water Soluble	E	X	E	-	-	-	-	-	E	E	E	E	-
Cyclohexane	E	X	G	-	E	X	E	E	G	G	G	G	-
Cyclohexanol	E												
Cyclohexanone	E	X	X	X	G	X	E	E	G	G	G	G	-
Cymene	E	X	X	X	G	X	-	-	E	E	E	E	E
Dasco FR 300													
Dasco FR150, FR200, FR200B, FR310		-	E	-	-	-	-	E	-	-	-	-	-

Underline is cover compound rating only. Many factors, such as temperature, concentration and length of exposure, are relevant to how chemical exposure impacts the tube and cover or fitting material. The fluid manufacturer's recommended maximum operating temperature should be carefully observed. Exceeding the manufacturer's recommended maximum temperature can result in fluid breakdown and cause harm or shorten the life of tube and cover materials. There may be instances where the hose cover could be adversely impacted by fluids which would not chemically impact the hose tube. Conversely, some fluids with an adverse affect on the tube of the hose may not have a deteriorating impact on the hose cover. It is recommended that the user test the hose/fluid compatibility to their own standards. Since no industry standards exist for chemical resistance, the Compass Chemical Resistance Guide for Elastomers is used whenever possible. Teflon® is a registered trademark of Dupont.

Chemical Resistance Tables

The following is a representative list of fluids, manufacturers and a general guideline for the use and compatibility of Continental hose and fittings.

Rating Scale

E Excellent resistance **X** Not Recommended
G Good Resistance **-** Testing Recommended **Blank** No Data

Chemical Name	Hose								Fittings and Adapters				
	PTFE (Teflon®)	CR (Polychloroprene)	NBR (Nitrile)	Nitrile / PVC	CPE	CSM	Urethane	Nylon	Carbon Steel	Stainless Steel 304	Stainless Steel 316	Aluminum	Brass
Dasco IFR		-	E	-	-	-	-	E	E	-	-	E	E
DDT Preparation (to 70°F) (in Kerosene)	E												
Decalin	E	X	G	-	G	X	-	E	-	-	-	-	E
Decol R&O Oil		X	E	-	-	-	G	-	-	-	-	-	-
Deionized Water													
Detergent/Water Solution	E												
Developing Fluids, Photo	E	G	-	-	E	G	-	-	-	E	E	-	-
Developing Solutions, Hypos	E	G	-	-	E	G	-	-	-	E	E	-	-
Dextron AFT													
Diacetone	E	X	X	X	E	X	-	E	E	E	E	E	E
Diammonium Phosphate (to 70°F)	E												
Dibenzyl Ether	E												
Dibutyl Ether	E												
Dibutyl Phthalate (Under 120°F)	E	X	X	X	G	X	G	-	E	E	E	E	E
Dichlorobenzene	E	X	X	X	X	X	X	-	E	E	E	X	E
Dichloroethylene	E												
Dieldrin													
Diesel Oil, Fuel ASTM #2	E	G	E	G	G	X	E	E	E	E	E	E	E
Diester Lubricant MIL-I-7809		X	G	-	-	-	-	-	E	E	E	E	-
Diester Synthetic Lubricants		X	G	-	-	-	-	-	E	E	E	E	-
Diethanolamine, 20%	E												
Diethyl Ether (Permeable)	E												
Diethyl Sebacate	E												
Diethylamine (Under 120°F)	E	G	G	-	G	X	-	E	E	E	E	E	E
Diethylene Glycol	E	E	E	E	E	E	E	E	E	E	E	E	E
Diisobutyl Ketone	E	X	X	X	G	X	-	E	E	E	E	E	E
Diisobutylene	E	X	G	-	E	X	-	-	G	E	E	G	E
Diisopropyl Ketone		X	X	X	G	X	-	E	E	E	E	E	E
Dimethyk Benzol													
Dimethyl Aniline	E	X	X	X	G	X	-	-	-	-	-	-	E
Dimethyl Formamide (Under 120°F)	-	X	X	X	-	-	-	-	E	E	E	E	-
Dimethyl Phthalate	E	X	X	X	E	X	-	-	-	-	G	-	E
Diocetyl Phthalate (DOP)	E	X	X	X	G	X	-	-	E	E	E	E	E
Diocetyl Sebacate		X	X	X	X	X	-	-	E	E	E	E	-
Diocetylphosphate													
Dipentene	E	X	X	-	G	-	-	-	E	E	E	E	E
Dirco Oils		-	E	-	-	-	-	E	E	E	E	E	E
Dispersing Oil #10		X	X	-	-	-	-	-	E	E	E	E	-

Underline is cover compound rating only. Many factors, such as temperature, concentration and length of exposure, are relevant to how chemical exposure affects the tube and cover or fitting material. The fluid manufacturer's recommended maximum operating temperature should be carefully observed. Exceeding the manufacturer's recommended maximum temperature can result in fluid breakdown and cause harm or shorten the life of tube and cover materials. There may be instances where the hose cover could be adversely affected by fluids which would not chemically affect the hose tube. Conversely, some fluids with an adverse affect on the tube of the hose may not have a deteriorating effect on the hose cover. It is recommended that the user test the hose/fluid compatibility to their own standards. Since no industry standards exist for chemical resistance, the Compass Chemical Resistance Guide for Elastomers is used whenever possible. Teflon® is a registered trademark of Dupont.

Chemical Resistance Tables

The following is a representative list of fluids, manufacturers and a general guideline for the use and compatibility of Continental hose and fittings.

Rating Scale

E Excellent resistance **X** Not Recommended
G Good Resistance **-** Testing Recommended **Blank** No Data

Chemical Name	Hose								Fittings and Adapters				
	PTFE (Teflon®)	CR (Polychloroprene)	NBR (Nitrile)	Nitrile / PVC	CPE	CSM	Urethane	Nylon	Carbon Steel	Stainless Steel 304	Stainless Steel 316	Aluminum	Brass
Dow Corning, C200, DC510, DC550, DC560		-	E	-	-	-	-	E	-	E	E	E	E
Dow HD 50-4													
Dowtherm 209													
Dowtherm A	E	X	X	X	G	X	X	-	E	E	E	E	E
Dowtherm E		X	X	-	G	-	-	-	E	E	E	E	E
DP47, 200 Flow-DOW		-	E	-	-	-	-	E	E	E	E	E	E
Duro AW-16, 31													
Duro FR-HD		-	E	-	-	-	X	E	-	-	-	-	-
Duro Oils		-	E	-	-	-	-	E	E	E	E	E	E
Elco 28-EP, Lubricant		X	E	-	-	-	-	-	E	E	E	E	-
Enamels	- E	-	-	-	-	-	E	-	-	-	-	E	
Energol HL 68		-	E	-	-	-	-	-	E	E	E	E	E
Energol HLPC 68		-	E	-	-	-	-	-	E	E	E	E	E
EP Hydraulic Oils, Chevron		-	E	-	-	-	-	-	E	E	E	E	E
Epichlorohydrin (Under 120°F)		X	X	-	-	-	-	-	E	G	E	E	-
Esam-6 Fluid		G	-	-	-	-	-	-	-	-	-	-	-
Ethanoic Acid	E												
Ethanol	E	E	E	-	E	-	X	E	-	-	-	-	-
Ethanolamine, Aminoethanol	E	G	G	-	E	X	X	E	E	E	E	E	E
Ethers (Under 120°F)	E	X	G	X	E	G	G	E	E	E	E	E	E
Ethyl Acetate	E	X	X	X	G	X	G	E	E	E	E	G	G
Ethyl Acetoacetate	E	X	X	X	E	X	X	-	E	E	E	E	E
Ethyl Acrylate	E	X	X	X	G	X	X	-	E	E	E	E	-
Ethyl Alcohol	E												
Ethyl Amine, Monoethylamine	E	X	X	X	E	X	X	-	G	E	E	G	E
Ethyl Benzene	E	X	X	X	G	X	E	-	E	E	E	E	E
Ethyl Bromide, Di	E	X	X	X	G	X	-	-	E	E	E	E	E
Ethyl Butyrate	E	X	X	X	-	-	-	-	-	E	E	E	-
Ethyl Cellulose	E	-	-	-	E	-	-	-	E	E	E	-	E
Ethyl Chloride	E	X	X	X	-	X	X	-	G	E	E	E	G
Ethyl Chloride, Dry	E	E	X	-	-	-	X	E	E	E	E	E	-
Ethyl Chloride, Wet	E	G	X	-	-	-	-	E	-	E	E	E	E
Ethyl Mercaptan	E	X	X	X	-	X	X	-	G	G	G	G	-
Ethyl Oxalate		X	X	-	E	-	E	-	-	-	-	-	-
Ethyl Pentachlorobenzene	E	-	X	-	X	-	E	-	-	-	-	-	-
Ethyl Silicate (to 70°F)	E	E	E	E	E	-	E	-	E	E	E	G	E
Ethylene Chlorohydrin, (Under 100°F)	E	X	X	X	-	-	X	X	E	E	G	X	-
Ethylene Diamine (Under 100°F)	E	G	G	G	E	X	X	-	E	E	E	X	E
Ethylene Dichloride (Permeable)	E	X	X	-	G	-	E	E	-	E	E	X	-

Underline is cover compound rating only. Many factors, such as temperature, concentration and length of exposure, are relevant to how chemical exposure affects the tube and cover or fitting material. The fluid manufacturer's recommended maximum operating temperature should be carefully observed. Exceeding the manufacturer's recommended maximum temperature can result in fluid breakdown and cause harm or shorten the life of tube and cover materials. There may be instances where the hose cover could be adversely affected by fluids which would not chemically affect the hose tube. Conversely, some fluids with an adverse effect on the tube of the hose may not have a deteriorating effect on the hose cover. It is recommended that the user test the hose/fluid compatibility to their own standards. Since no industry standards exist for chemical resistance, the Compass Chemical Resistance Guide for Elastomers is used whenever possible. Teflon® is a registered trademark of Dupont.

Chemical Resistance Tables

The following is a representative list of fluids, manufacturers and a general guideline for the use and compatibility of Continental hose and fittings.

Rating Scale

E Excellent resistance **X** Not Recommended
G Good Resistance **-** Testing Recommended **Blank** No Data

Chemical Name	Hose								Fittings and Adapters				
	PTFE (Teflon®)	CR (Polychloroprene)	NBR (Nitrile)	Nitrile / PVC	CPE	CSM	Urethane	Nylon	Carbon Steel	Stainless Steel 304	Stainless Steel 316	Aluminum	Brass
Ethylene Glycol	E	E	E	E	E	E	E	E	G	E	E	E	E
Ethylene Glycol, Ethyl Ether	E												
Ethylene Oxide	E												
Exxon Univolt 60, N61													
Factovis 52		-	E	-	-	-	-	-	E	E	E	E	E
Fatty Acids	E	G	G	G	G	X	E	E	X	G	E	E	-
Ferric Chloride	E	-	-	-	E	G	-	-	X	X	X	X	X
Ferric Chloride, 1%		E	E	-	-	-	-	E	X	G	G	X	X
Ferric Chloride, 1% Boiling		-	G	-	-	-	-	E	X	X	X	X	X
Ferric Chloride, 10%		G	E	-	-	-	-	E	X	X	X	X	X
Ferric Chloride, 5% Agitated or Aerated		G	G	-	-	-	-	E	X	X	X	X	X
Ferric Chloride, 5% Still		G	E	-	-	-	-	E	X	X	X	X	X
Ferric Sulfate	E	G	G	G	E	G	-	E	X	G	G	X	X
Ferrous Sulfate, Saturated	E	E	-	-	-	-	-	E	-	G	G	X	-
Ferrous Chloride	E	E	E	-	E	G	-	E	X	X	G	X	X
Ferrous Nitrate	E	G	G	G	-	G	-	-	-	E	E	-	-
Ferrous Salt Solutions	E												
Ferrous Sulfate, 10%	E	E	E	-	-	-	-	E	X	G	G	X	-
Ferrous Sulfate, Copper Gas	E	G	G	G	E	G	-	-	X	E	E	E	G
Fire Resistant Hydraulic Fluid, Texaco		-	E	-	-	-	-	-	E	E	E	E	E
Fire Safe, 225, 211													
Fire Safe, 1090E, 1150, 1220, 1300E, 155													
Firtec 290, MF		-	-	-	-	-	-	-	-	-	-	-	-
Fixing Solution, Photo		G	-	-	-	G	-	-	-	E	E	-	-
Flactid Acid													
Fluoboric Acid	E	E	E	-	E	-	-	-	E	-	E	X	-
Fluoboric Acid, 65%	E	G	-	-	E	G	X	-	-	E	E	-	-
Fluorine Gas, Dry or Wet	G												
Fluosilic Acid		G	E	-	-	-	-	-	X	X	X	X	E
Fluosilic Acid, 50%		G	X	X	E	G	X	X	-	-	-	E	-
Formaldehyde	E	E	X	-	E	-	-	G	E	E	E	E	X
Formaldehyde, 37%		G	-G	-	E	G	-G	-	-	E	E	E	E
Formaldehyde, Hot		-	-	-	-	-	-	E	X	G	E	G	E
Formic Acid (Under 120°F)	E	E	X	E	E	G	X	G	X	G	E	E	G
Formic Acid, Dilute Hot		E	X	-	-	-	-	X	X	G	E	G	X
Freon 113 (Permeable)													
Freon 114 (Permeable)	G												
Freon 12 (Permeable)	G												
Freon 22 (Permeable)													
Freon 502 (Permeable)													
Fuel Oil	E	G	E	E	E	X	G	E	G	G	G	E	G

Underline is cover compound rating only. Many factors, such as temperature, concentration and length of exposure, are relevant to how chemical exposure affects the tube and cover or fitting material. The fluid manufacturer's recommended maximum operating temperature should be carefully observed. Exceeding the manufacturer's recommended maximum temperature can result in fluid breakdown and cause harm or shorten the life of tube and cover materials. There may be instances where the hose cover could be adversely affected by fluids which would not chemically affect the hose tube. Conversely, some fluids with an adverse affect on the tube of the hose may not have a deteriorating effect on the hose cover. It is recommended that the user test the hose/fluid compatibility to their own standards. Since no industry standards exist for chemical resistance, the Compass Chemical Resistance Guide for Elastomers is used whenever possible. Teflon® is a registered trademark of Dupont.

Chemical Resistance Tables

The following is a representative list of fluids, manufacturers and a general guideline for the use and compatibility of Continental hose and fittings.

Rating Scale

- E** Excellent resistance
- G** Good Resistance
- X** Not Recommended
- Testing Recommended
- Blank** No Data

Chemical Name	Hose								Fittings and Adapters				
	PTFE (Teflon®)	CR (Polychloroprene)	NBR (Nitrile)	Nitrile / PVC	CPE	CSM	Urethane	Nylon	Carbon Steel	Stainless Steel 304	Stainless Steel 316	Aluminum	Brass
Fumaric Acid	E	G	X	-	-	-	X	-	E	E	E	-	-
Furan, Furfuran	E	X	X	X	E	-	-	-	E	E	E	E	E
Furfural	E												
Furfural Alcohol, Ant Oil	E	G	X	X	E	G	-	E	G	E	E	E	E
Fusel Oil, Grain Oil		X	X	-	-	-	-	-	-	-	-	-	-
Fyran Resin		X	X	-	-	-	-	-	-	-	E	-	-
Fyre Safe W/O													
Fyreguard 150, 200		-	E	-	-	-	-	-	E	E	E	E	E
Fyrquel 1000, 15R&O, 220R&O, 550R&O		X	X	-	-	-	-	-	E	-	-	E	-
Fyrquel A60, 90, 100, 150, 220, 300, 500		X	X	-	-	-	-	-	E	-	-	E	-
Gallic Acid	E	X	X	X	E	-	X	G	X	E	E	X	-
Gas Oil	E												
Gas, Natural	E	-	-	-	X	-	-	-	E	E	E	-	G
Gasohol (to 200°F)	E	G	X	X	-	X	-	-	G	E	E	E	E
Gasoline Unleaded, Under 50% Aromatics	E	X	X	X	-	X	X	-	G	E	E	E	E
Gasoline, Aviation	E	X	-	G	-	-	-	-	-	E	E	E	E
Gasoline, Meter		X	X	-	-	-	-	X	E	E	E	E	X
Gasoline, Premium	E	G	X	X	-	X	X	-	G	E	E	E	E
Gasoline, Sour	E	X	X	-	-	-	-	-	G	E	E	X	-
Gasoline, Standard	E	E	X	X	G	X	X	-	G	E	E	E	E
Gelatin	E	E	E	-	-	-	-	E	E	E	E	E	X
Glauber's Salt	-	G	X	-	-	-	-	-	E	E	E	-	-
Glucose	E	E	E	E	-	E	E	E	E	E	E	E	E
Glue (Under 120°F)	E	G	G	G	-	E	E	G	G	E	E	G	X
Glycerine, Glycol	E	E	E	E	E	E	E	E	G	E	E	E	G
Glycol FR Fluids	E	-	E	-	-	-	-	-	E	E	E	E	E
Glystantine													
Grease, Ester Base		-	-	-	-	-	-	E	E	E	E	E	E
Grease, Petroleum Base	E	G	E	G	-	G	E	E	E	E	E	E	E
Grease, Silicone Base		-	-	-	-	-	-	E	E	E	E	E	E
Green Sulfate Liquor, (Under 120°F)	E	G	G	E	G	-	-	-	E	E	E	-	-
Gulf FR Fluid G-200 (to 70°F)	E	-	E	-	-	-	X	-	E	E	E	E	E
Gulf FR Fluid P37, P40, P43, P45, P47 (to 70°F)	E	-	X	-	-	-	X	-	-	-	-	-	-
Gycols (Under 120°F)		E	E	E	E	E	E	E	G	E	E	E	E
H-515 (NATO)													
Halon													
Halowax Oil		X	X	X	-	X	-	-	-	-	-	-	-
Helium	E												
Hephtachlor, In Petroleum		-	G	X	-	-	-	-	-	-	-	-	-

Underline is cover compound rating only. Many factors, such as temperature, concentration and length of exposure, are relevant to how chemical exposure affects the tube and cover or fitting material. The fluid manufacturer's recommended maximum operating temperature should be carefully observed. Exceeding the manufacturer's recommended maximum temperature can result in fluid breakdown and cause harm or shorten the life of tube and cover materials. There may be instances where the hose cover could be adversely affected by fluids which would not chemically affect the hose tube. Conversely, some fluids with an adverse affect on the tube of the hose may not have a deteriorating effect on the hose cover. It is recommended that the user test the hose/fluid compatibility to their own standards. Since no industry standards exist for chemical resistance, the Compass Chemical Resistance Guide for Elastomers is used whenever possible. Teflon® is a registered trademark of Dupont.

Chemical Resistance Tables

The following is a representative list of fluids, manufacturers and a general guideline for the use and compatibility of Continental hose and fittings.

Rating Scale

E Excellent resistance **X** Not Recommended
G Good Resistance **-** Testing Recommended **Blank** No Data

Hose

Fittings and Adapters

Chemical Name	Hose								Fittings and Adapters				
	PTFE (Teflon®)	CR (Polychloroprene)	NBR (Nitrile)	Nitrile / PVC	CPE	CSM	Urethane	Nylon	Carbon Steel	Stainless Steel 304	Stainless Steel 316	Aluminum	Brass
Heptane (Under 100°F)	E	G	E	G	E	X	E	E	E	E	E	E	E
Hexane (Under 120°F)	E	G	E	G	G	E	E	E	E	E	E	E	E
Hexene	E	G	G	-	E	-	-	-	E	E	E	-	E
HF 20													
High Viscosity Lubricant, H2		G	E	-	-	-	-	-	-	-	-	-	-
High Viscosity Lubricant, U4		G	E	-	-	-	-	-	-	-	-	-	-
Hilo MS #1		X	X	-	-	-	-	-	-	-	-	-	-
Houghto-Safe 1010, 1055, (Phos, Ester) (to 70°F)	E	X	X	X	E	X	-	-	E	E	E	E	E
Houghto-Safe 1115, 1120, 1130, (Phos, Ester) (to 70°F)	E	X	X	X	E	X	-	-	E	E	E	E	E
Houghto-Safe 271, 416, 520, 616, (Water/Glycol) (to 70°F)	E	G	E	E	-	-	G	-	E	E	E	E	E
Hul-E-Mul													
Hy-Chock Oil		-	G	-	-	-	-	E	E	E	E	-	-
Hydrafluid 760, Texaco & Houghton		-	E	-	-	-	-	E	E	E	E	E	-
Hydrafluid AZR&O, A, B, AA, C		-	E	-	-	-	-	E	E	E	E	-	-
Hydrasol A		-	E	-	-	-	-	E	E	E	E	-	-
Hydraulic Fluid HF-18, HF-20		-	E	-	-	-	G	E	E	E	E	E	E
Hydraulic Fluid HF-31		-	-	-	-	-	-	E	E	E	E	E	E
Hydraulic Fluid, Phosphate Ester Base		X	X	X	E		X	E	E	E	E	-	-
Hydraulic Fluid, Std Petroleum Oils		G	E	G	E	G	G	E	E	E	E	E	E
Hydraulic Fluid, Water Glycol Base		E	E	E	-	-	E	E	E	E	E	E	E
Hydraulic Oils, Petroleum	E	G	E	-	-	-	-	E	E	E	E	E	E
Hydraulic Oils, Synthetic	E	-	X	-	-	-	-	-	E	E	E	E	E
Hydraulic Safety Fluid 200&300 Texaco		-	E	-	-	-	E	-	E	E	E	E	E
Hydrazine	E	X	X	X	-	X	-	-	X	E	E	E	-
Hydrobromic Acid		X	X	-	-	-	-	-	X	X	X	X	X
Hydrobromic Acid, 37%		X	X	X	E	G	X	X	X	X	X	X	X
Hydrochloric Acid (Permeable)	E	G	X	-	-	-	-	X	X	X	X	X	X
Hydrochloric Acid, 15%	E	X	X	X	E	G	X	X	X	X	X	X	X
Hydrochloric Acid, Concentrated		X	X	-	-	-	-	X	X	X	X	X	X
Hydrochloric Acid, 3 Molar		G	X	-	-	-	-	X	-	-	-	-	X
Hydrochloric Acid, 37%	E	X	-	X	E	G	X	X	X	X	X	X	X
Hydrocyanic Acid, 20% (Under 100°F)		X	X	X	-	G	X	E	X	E	E	E	X
Hydrocyanic Acid, 98%	E	-	-	-	-	-	-	-	-	-	-	-	-
Hydro-Drive Oil		-	E	-	-	-	G	-	-	-	-	-	-

Underline is cover compound rating only. Many factors, such as temperature, concentration and length of exposure, are relevant to how chemical exposure affects the tube and cover or fitting material. The fluid manufacturer's recommended maximum operating temperature should be carefully observed. Exceeding the manufacturer's recommended maximum temperature can result in fluid breakdown and cause harm or shorten the life of tube and cover materials. There may be instances where the hose cover could be adversely affected by fluids which would not chemically affect the hose tube. Conversely, some fluids with an adverse affect on the tube of the hose may not have a deteriorating effect on the hose cover. It is recommended that the user test the hose/fluid compatibility to their own standards. Since no industry standards exist for chemical resistance, the Compass Chemical Resistance Guide for Elastomers is used whenever possible. Teflon® is a registered trademark of Dupont.

Chemical Resistance Tables

The following is a representative list of fluids, manufacturers and a general guideline for the use and compatibility of Continental hose and fittings.

Rating Scale

E Excellent resistance **X** Not Recommended
G Good Resistance **-** Testing Recommended **Blank** No Data

Chemical Name	Hose								Fittings and Adapters				
	PTFE (Teflon®)	CR (Polychloroprene)	NBR (Nitrile)	Nitrile / PVC	CPE	CSM	Urethane	Nylon	Carbon Steel	Stainless Steel 304	Stainless Steel 316	Aluminum	Brass
Hydro-Drive Oil Houghton		-	E	-	-	-	G	-	-	-	-	-	-
Hydrofluoric Acid, 10%		X	X	X	E	E	X	X	X	X	X	X	X
Hydrofluoric Acid, 20% (Under 120°F)		X	X	X	E	G	X	X	X	X	X	X	X
Hydrofluoric Acid, 48% (Under 120°F)		X	X	X	E	G	X	X	X	X	X	X	X
Hydrofluoric Acid, 70% (Permeable)	E	-	X	X	-	G	X	X	X	X	X	X	X
Hydrofluoric Acid, Anhydrous		-	X	-	-	-	-	-	-	-	-	-	-
Hydrofluoric Acid, Concentrated	E	X	X	X	E	G	X	X	X	X	X	X	X
Hydrofluorosilicic Acid	E												
Hydrogen (Permeable)	E	E	E	-	E	-	-	-	X	X	X	E	-
Hydrogen Chloride Gas (Permeable)	E	-	-	-	E	-	-	-	-	E	E	-	-
Hydrogen Cyanide Gas (Permeable to 300°F)	E	-	-	-	-	-	-	-	-	-	-	E	-
Hydrogen Fluoride (Under 100°F) (Permeable)	E	-	X	-	-	-	-	-	G	G	E	-	-
Hydrogen Peroxide													
Hydrogen Peroxide, 10%	E	X	E	X	E	G	X	X	X	G	E	E	X
Hydrogen Peroxide, 30%	E	X	G	X	E	G	X	X	X	G	E	E	X
Hydrogen Peroxide, 70%	E	X	X	X	E	-	X	X	X	G	E	E	X
Hydrogen Peroxide, 90%		X	X	-	-	-	-	-	X	G	E	-	X
Hydrogen Peroxide, Dilute		E	G	-	-	-	-	E	E	-	E	-	X
Hydrogen Sulfide, Aqueous Solution		G	X	-	-	-	-	-	X	-	-	X	-
Hydrogen Sulfide, Dry, Cold		E	E	-	-	-	-	E	-	-	-	G	X
Hydrogen Sulfide, Dry, Hot		G	X	-	-	-	-	E	E	X	G	G	X
Hydrogen Sulfide, Gas	E	-	-	-	-	-	-	-	-	-	-	-	-
Hydrogen Sulfide, Wet, Cold (Permeable)	E	E	X	-	-	-	-	E	G	G	G	G	X
Hydrogen Sulfide, Wet, Hot	E	G	X	-	-	-	-	E	G	G	E	-	X
Hydrofluosilicic Acid													
Hydrolube, Water Glycol	E	G	E	-	-	-	X	-	X	-	E	-	-
Hydrolubric Oil, Houghton		-	G	-	-	-	G	E	-	-	-	-	-
Hydroquinone	E	X	-	-	-	X	-	-	-	E	E	G	-
Hydroxy Quinoline													
Hykil N°6 (33%), Water (67%)	E	-	G	-	-	-	-	-	E	-	-	-	-
Hypochlorous Acid, (Under 120°F)		X	X	X	-	G	-	E	G	G	G	X	-
Hypoid Grease (Parapoid 10-C)		-	E	-	-	-	-	-	-	-	-	-	-
Imol, Imol S150, S220, S300, S500		-	E	-	-	-	G	E	E	E	E	E	-
Industron 53		-	E	-	-	-	-	-	-	-	-	-	-

Underline is cover compound rating only. Many factors, such as temperature, concentration and length of exposure, are relevant to how chemical exposure affects the tube and cover or fitting material. The fluid manufacturer's recommended maximum operating temperature should be carefully observed. Exceeding the manufacturer's recommended maximum temperature can result in fluid breakdown and cause harm or shorten the life of tube and cover materials. There may be instances where the hose cover could be adversely affected by fluids which would not chemically affect the hose tube. Conversely, some fluids with an adverse effect on the tube of the hose may not have a deteriorating effect on the hose cover. It is recommended that the user test the hose/fluid compatibility to their own standards. Since no industry standards exist for chemical resistance, the Compass Chemical Resistance Guide for Elastomers is used whenever possible. Teflon® is a registered trademark of Dupont.

Chemical Resistance Tables

The following is a representative list of fluids, manufacturers and a general guideline for the use and compatibility of Continental hose and fittings.

Rating Scale

E Excellent resistance **X** Not Recommended
G Good Resistance **-** Testing Recommended **Blank** No Data

Chemical Name	Hose								Fittings and Adapters				
	PTFE (Teflon®)	CR (Polychloroprene)	NBR (Nitrile)	Nitrile / PVC	CPE	CSM	Urethane	Nylon	Carbon Steel	Stainless Steel 304	Stainless Steel 316	Aluminum	Brass
Ink (Printers)	E	E	E	-	-	-	-	E	G	G	E	-	G
Ink Oil	E	-	G	-	-	-	-	-	E	E	E	-	E
Insulating Oil (Transformer)	E	G	E	G	-	X	-	-	E	E	E	-	E
Iodine (Under 100°F) (Gas- Permeable)	E	X	X	-	E	G	X	E	G	G	G	X	-
Iodine Pentafluoride		X	X	-	-	-	-	-	X	G	G	X	-
Iodine, in Alcohol	E	G	-	-	-	-	X	-	-	-	-	X	-
Irus Fluid 902		-	E	-	-	-	E	E	E	E	E	E	E
Irus Fluid 905		-	E	-	-	-	E	E	E	E	E	E	E
Isobutane		X	X	-	-	-	X	X	X	E	E	G	E
Isocyanates (at 70°F)													
Isooctane		E	E	G	G	E	G	-	E	E	E	G	E
Isooctyl Thioglucolate	E	-	-	-	-	-	-	-	-	-	-	-	-
Isopropyl Acetate	E	X	X	X	-	X	G	E	G	G	E	X	E
Isopropyl Alcohol (Isopropanol)	E	G	G	G	E	G	G	E	E	E	E	E	G
Isopropyl Ether	E												
Isopropylamine													
Jet Fuel JP-3 (Under 100°F)	E	G	E	G	-	X	G	E	G	E	E	G	E
Jet Fuel JP-4	E	X	E	G	-	X	-	E	G	E	E	G	E
Jet Fuel JP-5	E	X	E	X	-	X	-	E	G	E	E	G	E
Jet Fuel JP-6	E	X	E	X	-	X	-	E	G	E	E	G	E
Jet Fuel JP-x (at 70°F)	E	G	E	X	-	X	-	E	G	E	E	G	E
Kerosene	E	X	E	G	E	X	-	E	E	E	E	E	E
Ketchup	E	E	E	-	-	-	-	E	-	E	E	-	-
Ketones	E	X	X	X	-	X	X	E	E	E	E	G	E
Keystone #87Hx-Grease+A334		X	E	-	-	-	-	-	E	E	E	E	-
Lacquer Solvents	E	X	X	X	-	X	G	E	X	G	E	E	E
Lacquers	E	X	X	X	-	X	-	E	X	X	E	E	E
Lactic Acid	E	E	X	X	-	E	X	-	X	G	E	X	G
Lactic Acid 10% Boiling	E	X	X	-	-	-	-	-	X	G	E	X	X
Lactic Acid 5%	E	G	E	-	-	-	-	E	X	G	E	E	X
Lactic Acid 5% Boiling	E	X	X	-	-	-	-	-	X	G	E	G	X
Lactol		G	G	G	-	-	-	-	E	E	E	E	E
Lasso (Ag Spray)		-	-	-	-	-	-	E	-	E	E	-	-
Latex	E	E	E	-	-	-	-	E	E	E	E	E	E
Lead Acetate	E	X	X	-	E	X	-	-	G	G	G	X	E
Lead Arsenate (to 70°F)	E	G	G	-	-	G	E	-	E	E	E	-	-
Lead Nitrate (to 300°F)	E	G	G	-	-	-	-	-	E	G	G	-	-
Lead Sulfate (to 300°F)	E	E	E	-	E	E	E	-	E	E	E	-	-
Lead Sulphamate (to 125°F)	E	G	G	-	-	G	-	-	-	-	-	-	-
Lead Tetramethyl	E	X	G	X	-	X	E	-	-	-	-	-	-

Underline is cover compound rating only. Many factors, such as temperature, concentration and length of exposure, are relevant to how chemical exposure affects the tube and cover or fitting material. The fluid manufacturer's recommended maximum operating temperature should be carefully observed. Exceeding the manufacturer's recommended maximum temperature can result in fluid breakdown and cause harm or shorten the life of tube and cover materials. There may be instances where the hose cover could be adversely affected by fluids which would not chemically affect the hose tube. Conversely, some fluids with an adverse affect on the tube of the hose may not have a deteriorating effect on the hose cover. It is recommended that the user test the hose/fluid compatibility to their own standards. Since no industry standards exist for chemical resistance, the Compass Chemical Resistance Guide for Elastomers is used whenever possible. Teflon® is a registered trademark of Dupont.

Chemical Resistance Tables

The following is a representative list of fluids, manufacturers and a general guideline for the use and compatibility of Continental hose and fittings.

Rating Scale

E Excellent resistance **X** Not Recommended
G Good Resistance **-** Testing Recommended **Blank** No Data

Chemical Name	Hose								Fittings and Adapters				
	PTFE (Teflon®)	CR (Polychloroprene)	NBR (Nitrile)	Nitrile / PVC	CPE	CSM	Urethane	Nylon	Carbon Steel	Stainless Steel 304	Stainless Steel 316	Aluminum	Brass
Lead, Tetraethyl (Under 100°F)	E	X	G	X	-	X	-	-	-	-	-	-	-
Lecithin	E	G	X	-	-	-	-	-	-	E	E	-	-
Ligroin (Petroleum Ether, Under 120°F)	E	X	E	-	-	X	-	-	G	E	E	X	-
Lime (Chlorinated Free Chlorine 20%)		-	E	-	E	-	E	-	-	-	G	-	-
Lime Bleach (Under 100°F)	-	X	G	X	-	X	-	-	X	G	E	-	-
Lime Sulphur		E	X	-	-	-	-	E	G	E	E	X	X
Lime Sulphur (Under 135°F)	E	E	X	X	-	G	-	E	G	E	E	X	X
Lindane (Ag Spray)		-	-	-	-	-	-	E	-	E	E	-	-
Lindol HF (to 200°F)	E												
Lindol, Hydraulic Fluid (to 200°F)	E	X	X	-	-	-	-	-	E	E	E	E	-
Linoleic Acid	E	X	G	X	-	-	-	-	X	G	E	E	-
Linseed Oil	E	X	E	-	-	-	-	E	E	E	E	G	G
Linseed Oil (Boiled)		G	G	E	E	E	E	-	G	E	E	E	G
LPG													
Lubricating Oil (Diester Under 135°F)		X	G	X	-	-	X	E	E	E	E	E	E
Lubricating Oil (Petroleum Base)	E	G	E	G	E	G	G	E	E	E	E	E	E
Lubricating Oil (SAE 10, 20, 30, 40, 50)	E	G	G	-	-	-	-	E	E	E	E	E	-
Machine Oil (Under 135°F)	E	E	E	G	-	G	G	-	E	E	E	E	E
Magnesium Carbonate	E	E	E	E	-	E	E	-	G	G	G	E	-
Magnesium Chloride	E	E	E	E	E	E	E	E	X	G	E	X	G
Magnesium Hydroxide	E	G	G	G	E	E	X	-	E	E	E	X	X
Magnesium Nitrate	E	G	G	G	-	E	-	-	G	G	G	X	E
Magnesium Sulfate	S	G	G	G	E	E	E	E	G	G	G	G	G
Malation (Ag Spray Dilute)		-	G	-	-	-	-	E	E	E	E	-	E
Maleic Acid	E	G	X	-	-	-	-	E	-	E	E	G	G
Manganese Salts (to 70°F)	E	-	E	E	-	E	-	-	-	-	-	-	-
Maximul (Penzoil Hydraulic Fluid)		G	E	G	-	-	-	-	E	-	E	-	-
Mercuric Chloride	E	E	G	G	E	E	G	X	X	G	G	X	X
Mercuric Cyanide	E	E	G	G	-	E	-	-	G	G	G	X	-
Mercurous Nitrate (Under 120°F)	E	E	G	G	-	E	-	-	E	E	E	X	-
Mercury	E	E	G	G	E	E	G	E	E	E	E	X	X
Mesityl Oxide	E	X	X	X	G	X	X	-	E	E	E	E	E
Methane (Gas or Liquid)	E	G	E	-	-	-	-	-	-	E	E	-	-
Methanol													
Methoxychlor (Insecticide)		-	-	-	-	-	-	X	E	E	E	-	-
Methyl Acetate	E	X	X	X	E	X	-	-	E	E	E	E	E

Underline is cover compound rating only. Many factors, such as temperature, concentration and length of exposure, are relevant to how chemical exposure affects the tube and cover or fitting material. The fluid manufacturer's recommended maximum operating temperature should be carefully observed. Exceeding the manufacturer's recommended maximum temperature can result in fluid breakdown and cause harm or shorten the life of tube and cover materials. There may be instances where the hose cover could be adversely affected by fluids which would not chemically affect the hose tube. Conversely, some fluids with an adverse affect on the tube of the hose may not have a deteriorating effect on the hose cover. It is recommended that the user test the hose/fluid compatibility to their own standards. Since no industry standards exist for chemical resistance, the Compass Chemical Resistance Guide for Elastomers is used whenever possible. Teflon® is a registered trademark of Dupont.

Chemical Resistance Tables

The following is a representative list of fluids, manufacturers and a general guideline for the use and compatibility of Continental hose and fittings.

Rating Scale

E Excellent resistance **X** Not Recommended
G Good Resistance **-** Testing Recommended **Blank** No Data

Chemical Name	Hose								Fittings and Adapters				
	PTFE (Teflon®)	CR (Polychloroprene)	NBR (Nitrile)	Nitrile / PVC	CPE	CSM	Urethane	Nylon	Carbon Steel	Stainless Steel 304	Stainless Steel 316	Aluminum	Brass
Methyl Acrylate	E	X	X	X	-	X	-	-	E	E	E	E	E
Methyl Alcohol, Methanol	E												
Methyl Amine (25% Aqueous Solution)	E	G	X	-	-	-	-	-	E	E	E	E	-
Methyl Amine (60%)		G	G	-	-	-	-	G	E	E	E	E	G
Methyl Amine (99%)		X	X	-	-	-	-	-	E	E	E	E	X
Methyl Amyl Carbinol	E	-	-	-	E	-	-	-	E	E	E	-	-
Methyl Bromide	E	X	X	X	-	X	X	X	E	E	E	X	E
Methyl Butyl Ketone (MBK)	E	X	X	X	G	X	-	-	E	E	E	E	E
Methyl Cellusolve (Under 100°F)	E	G	X	-	E	X	-	-	G	G	G	G	E
Methyl Chloride		X	X	X	X	X	-	E	G	E	E	X	E
Methyl Ethyl Ketone (MEK)	E	X	X	X	G	X	X	E	E	E	E	G	E
Methyl Formate	E	G	X	X	-	X	-	-	G	E	E	E	E
Methyl Isobutyl Ketone (MBK, 100°F)	E	X	X	X	G	X	X	G	G	G	G	G	E
Methyl Isopropyl Ketone	E	X	X	X	G	X	X	-	G	E	E	E	E
Methyl Methacrylate	E	X	X	X	G	G	-	-	G	G	G	-	-
Methyl Ethyl Ketone					-								
Methyl Salicylate	E	G	G	G	-	-	-	-	E	E	E	E	E
Methyl Sulfate (Dinethyl, Under 100°F)	E	X	X	X	-	X	E	-	-	-	-	-	-
Methylene Chloride	E	X	X	X	X	X	-	G	G	G	G	X	E
Methylene Dichloride	E	X	X	X	-	-	-	E	E	E	E	X	E
Methylhalides													
MIL-F-7083													
MIL-H-5606													
MIL-H-83282													
MIL-L-2104 & 2104B													
MIL-L-7808													
MIL-O-6083													
Mine Guard FR													
Mineral Oil (Under 120°F)													
Mineral Spirit		-	E	G	-	X	-	-	E	E	E	G	E
MLO-8220 Hydro		E	G	-	-	-	-	-	E	E	E	E	-
MLO-7277 Hydro		X	X	-	-	-	-	-	E	E	E	E	-
MLO-7557		E	X	-	-	-	-	-	E	E	E	E	-
MLO-8515		E	G	-	-	-	-	E	E	E	E	E	-
Mobil DTE													
Mobil HFA													
Mobil Rarus 824, 826, 827													
Mobil SHC 600 Series													
Mobil SHC 800 Series													
Mobil Vectra Oil													

Underline is cover compound rating only. Many factors, such as temperature, concentration and length of exposure, are relevant to how chemical exposure affects the tube and cover or fitting material. The fluid manufacturer's recommended maximum operating temperature should be carefully observed. Exceeding the manufacturer's recommended maximum temperature can result in fluid breakdown and cause harm or shorten the life of tube and cover materials. There may be instances where the hose cover could be adversely affected by fluids which would not chemically affect the hose tube. Conversely, some fluids with an adverse affect on the tube of the hose may not have a deteriorating effect on the hose cover. It is recommended that the user test the hose/fluid compatibility to their own standards. Since no industry standards exist for chemical resistance, the Compass Chemical Resistance Guide for Elastomers is used whenever possible. Teflon® is a registered trademark of Dupont.

Chemical Resistance Tables

The following is a representative list of fluids, manufacturers and a general guideline for the use and compatibility of Continental hose and fittings.

Rating Scale

E Excellent resistance **X** Not Recommended
G Good Resistance **-** Testing Recommended **Blank** No Data

Chemical Name	Hose								Fittings and Adapters				
	PTFE (Teflon®)	CR (Polychloroprene)	NBR (Nitrile)	Nitrile / PVC	CPE	CSM	Urethane	Nylon	Carbon Steel	Stainless Steel 304	Stainless Steel 316	Aluminum	Brass
Mobile Hydraulic Oils		-	E	-	-	-	G	-	E	E	E	E	-
Mobile Therm 603		-	E	-	-	-	-	-	E	E	E	E	E
Mobilfluid 423													
Mobilmet S122		-	E	-	-	-	G	-	-	-	-	-	-
Mobilrama 525													
Molasses (Under 120°F)	E	G	G	G	-	E	E	-	G	E	E	G	X
Monochlorobenzene (Permeable)	E	X	X	X	X	X	X	X	E	E	E	X	E
Monoethanolamine	E	X	G	-	E	X	-	-	E	E	E	G	E
Morpholine (Pure Additive)	E												
Motor Oils (Under 135°F)	E	G	E	G	E	G	G	E	E	E	E	E	E
Mould Oil		-	-	-	-	-	-	-	E	E	E	-	-
Muriatic Acid (Permeable)	E	X	X	X	E	G	X	X	X	X	X	X	X
Mustard	E	E	G	E	-	E	-	-	X	E	E	G	-
NaK													
Naphtenic Acid	E												
Naphtha (Low Aromatic Content)	E	X	G	X	E	X	-	E	G	E	E	E	E
Naphthalene	E	X	X	X	-	X	-	-	E	E	E	-	E
Naphthalene (Tar Camphor)	E	X	X	X	E	X	-	E	E	E	E	E	E
Natural Gas	E												
Neon Gas	E												
N-Hexaldehyde	E	G	X	G	-	-	-	-	E	E	E	E	E
Nickel Acetate	E	G	G	-	-	-	-	-	E	G	G	E	E
Nickel Chloride	E	G	G	G	E	G	-	E	X	G	G	X	X
Nickel Nitrate	E	G	G	G	E	G	-	E	G	G	G	X	-
Nickel Plating Solution		-	G	-	-	G	X	-	-	E	E	-	-
Nickel Salts	E	G	-	E	-	-	-	-	-	-	-	-	-
Nickel Sulfate	E												
Nicotine Salts	E	-	-	-	-	-	E	-	E	X	G	-	-
Nitric Acid	E	X	X	-	-	-	-	-	X	E	E	-	X
Nitric Acid & Hydrochloric Acid		-	X	-	-	-	-	-	X	X	X	X	-
Nitric Acid, 20%	E	X	X	X	E	G	X	X	X	G	G	X	X
Nitric Acid, 3M		X	X	-	-	-	-	-	X	E	E	-	X
Nitric Acid, 5% to 10%	E	X	X	X	E	G	X	X	X	G	G	E	X
Nitric Acid, 50% (Boiling)		X	X	X	X	X	X	X	X	G	G	X	X
Nitric Acid, 65% (Boiling)		X	X	X	X	X	X	X	X	G	G	X	X
Nitric Acid, Concentrated (Boiling)		X	X	-	-	-	-	X	X	G	G	X	X
Nitric Acid, Inhibited RED Fuming (IRFNA)		X	X	-	-	-	-	-	X	E	E	E	X
Nitric Acid, Red Fuming (RNFA)	E	X	X	X	-	X	X	X	X	G	G	G	X

Underline is cover compound rating only. Many factors, such as temperature, concentration and length of exposure, are relevant to how chemical exposure affects the tube and cover or fitting material. The fluid manufacturer's recommended maximum operating temperature should be carefully observed. Exceeding the manufacturer's recommended maximum temperature can result in fluid breakdown and cause harm or shorten the life of tube and cover materials. There may be instances where the hose cover could be adversely affected by fluids which would not chemically affect the hose tube. Conversely, some fluids with an adverse affect on the tube of the hose may not have a deteriorating effect on the hose cover. It is recommended that the user test the hose/fluid compatibility to their own standards. Since no industry standards exist for chemical resistance, the Compass Chemical Resistance Guide for Elastomers is used whenever possible. Teflon® is a registered trademark of Dupont.

Chemical Resistance Tables

The following is a representative list of fluids, manufacturers and a general guideline for the use and compatibility of Continental hose and fittings.

Rating Scale

E Excellent resistance	X Not Recommended
G Good Resistance	- Testing Recommended
Blank No Data	

Chemical Name	Hose								Fittings and Adapters				
	PTFE (Teflon®)	CR (Polychloroprene)	NBR (Nitrile)	Nitrile / PVC	CPE	CSM	Urethane	Nylon	Carbon Steel	Stainless Steel 304	Stainless Steel 316	Aluminum	Brass
Nitrobenzene (Under 100°F)	E	X	X	X	G	X	X	-	G	G	G	G	E
Nitroethane	E	X	X	X	E	G	-	-	E	E	E	E	E
Nitrogen	E	E	E	G	E	E	E	E	E	E	E	E	E
Nitrogen Fertilizer Solution													
Nitrogen Oxide up to 50% (Under 100°F)		E	E	G	E	E	-	E	E	E	E	-	X
Nitromethane (Permeable)	E	X	X	X	-	-	-	E	E	E	E	E	E
Nitropropane		X	X	X	-	-	-	E	E	E	E	E	E
Nitrous Oxide (Gas)	E												
N-Octane		X	G	-	E	X	-	-	E	E	E	-	E
Nuto H													
Nyvac 20 (WG), 30 (WG)		-	E	-	-	-	-	-	E	E	E	E	E
Nyvac FR Fluid		-	E	-	-	-	-	-	E	E	E	E	E
Nyvac FR200 Fluid		-	E	-	-	-	-	-	E	E	E	E	E
O-148 (NATO)													
Octyl Alcohol	E												
Oil (SAE, Under 100°F)	E	E	E	E	E	G	E	E	E	E	E	E	E
Oil Synthetic Blends													
Oils Crude	E	X	G	-	-	-	-	-	-	E	E	-	-
Oleic Acid (Under 120°F)	E	G	G	G	E	G	E	E	G	G	E	E	G
Oleum 25%													
Oleum Spirits (to 70°F)	E												
Olive Oil	E	X	G	G	G	X	-	-	G	E	E	E	G
Orthodichlorobenzene													
OS 45 Type III (OS45)	E	E	G	-	-	-	-	-	-	-	-	-	-
OS 45 Type IV (OS45-1)	E	E	G	-	-	-	-	-	-	-	-	-	-
OS 70		E	G	-	-	-	-	-	-	-	-	-	-
Oxalic Acid (5%, Hot and Cold)		G	G	-	-	-	-	G	X	G	E	E	X
Oxalic Acid	E	X	X	X	E	G	X	X	X	G	E	G	X
Oxalic Acid (10% Boiling)		X	X	-	-	-	-	-	X	X	X	X	X
Oxalic Acid (10%)		G	G	-	-	-	-	G	X	G	E	E	X
Oxygen (200°-400°F)		X	X	-	-	-	-	-	-	-	-	-	-
Oxygen Cold		E	G	-	E	-	-	E	G	E	E	E	E
Oxygen Gaseous	E	-	-	-	-	-	-	-	-	-	-	E	-
Ozone (Dry)	E	G	X	G	E	G	E	G	E	E	E	E	E
Ozone (Wet)	E	-	X	-	-	-	-	-	X	G	E	G	-
Pacemaker Types 150T, 300T, 500T (Citgo)		-	E	-	-	-	-	-	-	-	-	-	-
Paint	E	X	-	-	-	X	X	G	-	E	E	E	E
Paint Solvents (Oil Base)		X	X	-	-	X	X	G	-	E	E	E	E
Paint Thinner, Duco	E	G	E	-	-	-	-	E	G	G	E	G	X
Paints (Oil Base)	E	-	E	-	-	E	-	E	-	-	-	-	-

Underline is cover compound rating only. Many factors, such as temperature, concentration and length of exposure, are relevant to how chemical exposure affects the tube and cover or fitting material. The fluid manufacturer's recommended maximum operating temperature should be carefully observed. Exceeding the manufacturer's recommended maximum temperature can result in fluid breakdown and cause harm or shorten the life of tube and cover materials. There may be instances where the hose cover could be adversely affected by fluids which would not chemically affect the hose tube. Conversely, some fluids with an adverse affect on the tube of the hose may not have a deteriorating effect on the hose cover. It is recommended that the user test the hose/fluid compatibility to their own standards. Since no industry standards exist for chemical resistance, the Compass Chemical Resistance Guide for Elastomers is used whenever possible. Teflon® is a registered trademark of Dupont.

Chemical Resistance Tables

The following is a representative list of fluids, manufacturers and a general guideline for the use and compatibility of Continental hose and fittings.

Rating Scale

- E** Excellent resistance
- G** Good Resistance
- X** Not Recommended
- Testing Recommended
- Blank** No Data

Chemical Name	Hose								Fittings and Adapters				
	PTFE (Teflon®)	CR (Polychloroprene)	NBR (Nitrile)	Nitrile / PVC	CPE	CSM	Urethane	Nylon	Carbon Steel	Stainless Steel 304	Stainless Steel 316	Aluminum	Brass
Palm Oil	E	G	E	G	-	G	-	-	E	E	E	E	E
Palmitic Acid	E	G	G	G	E	X	E	E	G	G	E	E	X
Paradichlorobenzene													
Paraffin (Petroleum)		G	E	G	E	X	-	E	G	E	E	E	E
Paraformaldehyde	E	G	G	G	-	G	G	-	E	E	E	E	-
Peanut Oil (Under 100°F)	E	G	E	G	-	-	-	-	E	E	E	E	E
Pentane (Gas or Liquid)	E												
Pentasol		G	G	G	-	G	-	-	E	E	E	E	E
Perchloric Acid	E	X	X	-	-	G	X	X	X	G	E	X	-
Perchloroethylene (Tetrachloroethylene)	E	X	X	X	G	X	-	G	E	E	E	X	X
Petroleum Oil (Above 250°F)	E	X	X	-	-	-	-	-	-	-	-	-	-
Petroleum Oil (Crude)	E	G	E	-	-	-	-	-	-	-	-	-	-
Petroleum Oil (Under 250°F)		G	E	-	-	-	-	-	-	-	-	-	-
Petroleum Oils (Refined)		G	E	G	-	G	G	E	E	E	E	E	E
Petroleum Oils (Sour)	E	G	G	-	-	X	G	-	G	E	E	E	X
Petroleum Oils (Under 100°F)		G	E	G	-	G	G	-	E	E	E	E	E
Phenol (70/30 Water)		X	X	-	-	-	-	-	-	E	E	E	-
Phenol (85/15 Water)		X	X	-	-	-	-	-	-	E	E	E	-
Phenol (Carbolic Acid)	E	X	X	X	E	X	X	X	G	E	E	E	X
Phenylamine													
Phorone (Diisopropylidene Acetone)	E	X	X	-	-	X	X	-	E	E	E	-	E
Phosphate Esters (3 Molar)		X	X	-	G	G	X	G	-	-	-	-	-
Phosphate Esters (Concentrated)	E	X	X	-	X	X	X	G	-	-	-	-	-
Phosphate Esters (Dilute)	E	X	X	-	E	E	X	G	-	-	-	-	-
Phosphoric Acid	E	G	G	-	-	-	-	-	-	-	G	-	-
Phosphoric Acid (1%)		G	-	-	-	-	-	-	-	E	E	-	X
Phosphoric Acid (10% Hot)		G	X	-	-	-	-	-	X	-	E	X	X
Phosphoric Acid (10%)		G	X	-	-	-	-	-	X	-	E	X	X
Phosphoric Acid (3 Molar)		X	X	-	-	-	-	-	-	-	-	-	-
Phosphoric Acid (5%)		G	X	-	-	-	-	-	-	E	E	-	X
Phosphoric Acid (50% Hot)		G	X	-	-	-	-	-	X	X	G	X	X
Phosphoric Acid (50%)		G	G	G	E	E	X	X	X	G	E	X	G
Phosphoric Acid (85% Hot)		G	X	-	-	-	-	-	X	X	X	X	X
Phosphoric Acid (85%)		G	X	-	E	E	X	X	X	G	G	X	X
Phosphoric Acid (Aerated)		-	-	-	-	-	-	-	X	-	G	-	-
Phosphoric Acid (Concentrated)	E	X	X	-	-	-	-	-	-	-	-	-	-
Phosphoric Acid (Air Free)		-	-	-	-	-	-	-	X	-	-	X	-
Phosphorous Trichloride	E												

Underline is cover compound rating only. Many factors, such as temperature, concentration and length of exposure, are relevant to how chemical exposure affects the tube and cover or fitting material. The fluid manufacturer's recommended maximum operating temperature should be carefully observed. Exceeding the manufacturer's recommended maximum temperature can result in fluid breakdown and cause harm or shorten the life of tube and cover materials. There may be instances where the hose cover could be adversely affected by fluids which would not chemically affect the hose tube. Conversely, some fluids with an adverse affect on the tube of the hose may not have a deteriorating effect on the hose cover. It is recommended that the user test the hose/fluid compatibility to their own standards. Since no industry standards exist for chemical resistance, the Compass Chemical Resistance Guide for Elastomers is used whenever possible. Teflon® is a registered trademark of Dupont.

Chemical Resistance Tables

The following is a representative list of fluids, manufacturers and a general guideline for the use and compatibility of Continental hose and fittings.

Rating Scale

E Excellent resistance **X** Not Recommended
G Good Resistance **-** Testing Recommended **Blank** No Data

Chemical Name	Hose								Fittings and Adapters				
	PTFE (Teflon®)	CR (Polychloroprene)	NBR (Nitrile)	Nitrile / PVC	CPE	CSM	Urethane	Nylon	Carbon Steel	Stainless Steel 304	Stainless Steel 316	Aluminum	Brass
Photographic, Developers	E	E	E	-	-	-	-	-	X	E	E	-	-
Photographic, Emulsions	E	-	-	-	-	-	-	-	-	-	-	-	-
Photographic, Fixing Solutions	E	G	-	-	-	G	-	-	-	E	E	-	-
Phthalic Acid	-	-	-	-	-	-	-	-	G	G	E	G	-
Picric Acid (Water Solution 100°F)	E	G	G	G	-	G	G	X	X	E	E	X	X
Picric Acid Molten	-	-	-	-	-	-	-	-	-	-	-	-	-
Pine Oil	E	X	G	-	G	X	-	E	E	E	E	E	-
Pinene	E	X	G	-	G	-	-	-	E	E	E	E	E
Piperazine Hydrochloride Solution (34%)	-	-	G	-	-	-	-	-	-	-	-	-	-
Pitch	-	G	E	-	-	G	G	E	-	-	-	-	-
Plating Solutions (Chrome)	E	X	X	-	-	-	X	X	-	X	X	-	-
Plating Solutions (Other)	E	-	E	-	-	-	-	-	-	-	-	-	-
Polyester Resin	-	-	-	-	-	-	-	G	-	-	-	-	-
Polyol Ester	-	-	-	-	-	-	-	-	-	-	-	-	-
Polyurethane Foam (Under 125°F)	-	-	-	-	-	-	-	-	-	-	-	-	-
Potassium Acetate	E	G	G	-	E	G	X	-	G	E	E	X	-
Potassium Bicarbonate	E	E	E	-	-	E	-	E	E	G	G	E	-
Potassium Bisulfite	E	-	E	-	-	-	-	E	-	-	-	-	-
Potassium Bromate	E	-	-	-	-	-	-	-	-	-	-	-	-
Potassium Bromide	E	E	E	-	-	E	G	E	X	X	G	X	-
Potassium Carbonate (Potash)	E	E	E	E	E	E	G	E	G	E	E	X	X
Potassium Chlorate	E	E	E	-	-	-	G	E	G	G	G	G	-
Potassium Chloride (1% to 5%)	E	E	E	-	E	-	G	E	E	G	G	X	X
Potassium Chloride (Boiling)	-	-	-	-	-	-	-	-	-	G	G	-	X
Potassium Cyanide	E	E	E	-	E	-	-	E	G	G	G	X	X
Potassium Dichromate	E	E	E	-	E	-	-	G	E	G	G	G	-
Potassium Ferrocyanide	E	-	-	-	-	-	-	-	G	E	E	G	-
Potassium Fluoride	E	-	-	-	-	-	-	-	-	-	-	-	-
Potassium Hydroxide	E	G	G	-	-	-	-	-	E	E	E	-	-
Potassium Hydroxide (27% Boiling)	-	-	-	-	-	-	-	-	G	G	E	X	X
Potassium Hydroxide (5%)	-	E	E	-	-	-	-	E	G	G	G	X	X
Potassium Hydroxide (50% Boiling)	-	-	-	-	-	-	-	-	G	G	G	X	X
Potassium Hydroxide (70% Hot)	-	-	-	-	-	-	-	-	X	-	-	X	X
Potassium Hydroxide (70%)	-	-	E	-	-	-	-	-	-	-	-	X	X

Underline is cover compound rating only. Many factors, such as temperature, concentration and length of exposure, are relevant to how chemical exposure affects the tube and cover or fitting material. The fluid manufacturer's recommended maximum operating temperature should be carefully observed. Exceeding the manufacturer's recommended maximum temperature can result in fluid breakdown and cause harm or shorten the life of tube and cover materials. There may be instances where the hose cover could be adversely affected by fluids which would not chemically affect the hose tube. Conversely, some fluids with an adverse affect on the tube of the hose may not have a deteriorating effect on the hose cover. It is recommended that the user test the hose/fluid compatibility to their own standards. Since no industry standards exist for chemical resistance, the Compass Chemical Resistance Guide for Elastomers is used whenever possible. Teflon® is a registered trademark of Dupont.

Chemical Resistance Tables

The following is a representative list of fluids, manufacturers and a general guideline for the use and compatibility of Continental hose and fittings.

Rating Scale

E Excellent resistance **X** Not Recommended
G Good Resistance **-** Testing Recommended **Blank** No Data

Chemical Name	Hose								Fittings and Adapters				
	PTFE (Teflon®)	CR (Polychloroprene)	NBR (Nitrile)	Nitrile / PVC	CPE	CSM	Urethane	Nylon	Carbon Steel	Stainless Steel 304	Stainless Steel 316	Aluminum	Brass
Potassium Hydroxide (30% Caustic Potash)		-	-	-	E	-	-	-	-	-	-	-	-
Potassium Iodide		E	E	-	-	E	-	E	E	G	G	-	-
Potassium Nitrate	E	E	E	-	E	-	E	E	E	E	G	G	G
Potassium Nitrate (1% to 5%)		E	E	-	-	-	-	-	E	E	E	E	G
Potassium Permanganate	E	E	G	-	-	-	-	G	E	G	G	G	-
Potassium Permanganate (5%)		E	E	-	-	-	-	E	E	E	E	E	-
Potassium Persulfate	E	-	-	-	-	-	-	-	-	-	-	-	-
Potassium Phosphate	E	E	-	-	-	E	-	-	X	G	G	X	-
Potassium Sulfate	E	E	E	-	E	-	E	E	E	G	G	E	-
Potassium Sulfate 1% & 5%		E	E	-	-	-	-	E	E	E	E	E	X
Potassium Sulfide		E	E	-	-	-	-	-	G	G	G	-	-
Potassium Sulfite (to 300°F)	E	E	E	-	E	-	-	-	E	E	E	E	-
Potassium Thiosulfate	E	E	-	-	-	E	-	-	-	-	-	-	-
Primatol A, S, P (Ag Spray)		-	-	-	-	-	-	-	-	-	-	-	-
PRL-High Temp Hydraulic Oil		G	E	-	-	-	-	-	E	E	E	E	-
Propane Gas	E	X	X	-	-	-	X	X	X	E	E	E	-
Propionic Acid	E	X	X	-	-	-	-	-	E	-	G	G	-
Propyl Acetate	E	X	X	-	G	-	-	-	E	-	-	-	-
Propylene (Liquid or Gas, Ambient)	E	X	X	-	E	-	-	G	E	E	E	E	-
Propylene Dichloride	E	-	-	-	-	-	-	-	E	G	E	X	-
Propylene Glycol		E	X	-	E	E	E	G	E	G	G	E	-
Propylene Oxide (Permeable)	E	X	X	-	-	-	-	-	G	E	E	E	-
Purina Insecticide		X	X	-	-	-	-	G	E	E	E	E	G
Puropale RX Oils		-	E	-	-	-	G	E	E	E	E	E	E
Pydraulic		X	X	-	-	-	-	-	-	-	-	-	-
Pydraulic 10E,29E-LT,30E,60,65E,115E		X	X	-	G	-	-	-	E	E	E	E	E
Pydraulic 135 (to 70°F)	E	-	X	-	G	-	-	G	E	E	E	-	-
Pydraulic 150		X	X	X	G	X	G	G	E	E	E	E	E
Pydraulic 280 (at 400°F)	G	X	X	X	G	X	G	G	E	E	E	-	-
Pydraulic 312 (to 70°F)	E	X	X	X	G	-	G	E	E	E	E	-	-
Pydraulic 50E		-	-	-	G	-	G	E	E	E	E	-	-
Pydraulic 540 (to 70°F)	E	X	X	X	G	X	X	X	E	E	E	-	-
Pydraulic 625		X	X	X	G	X	G	G	E	E	E	-	-
Pydraulic A-200		X	X	X	G	X	X	G	E	E	E	-	-
Pydraulic F-9		X	X	X	G	X	G	E	E	E	E	-	-
Pyrano, Transformer Oil (to 70°F)	E	G	E	-	-	-	-	-	E	E	E	E	-
Pyridine	E	X	X	-	-	X	E	-	E	E	E	E	E
Pyrogard 160, 230, 630		-	-	-	-	-	-	-	E	E	E	-	-

Underline is cover compound rating only. Many factors, such as temperature, concentration and length of exposure, are relevant to how chemical exposure affects the tube and cover or fitting material. The fluid manufacturer's recommended maximum operating temperature should be carefully observed. Exceeding the manufacturer's recommended maximum temperature can result in fluid breakdown and cause harm or shorten the life of tube and cover materials. There may be instances where the hose cover could be adversely affected by fluids which would not chemically affect the hose tube. Conversely, some fluids with an adverse affect on the tube of the hose may not have a deteriorating effect on the hose cover. It is recommended that the user test the hose/fluid compatibility to their own standards. Since no industry standards exist for chemical resistance, the Compass Chemical Resistance Guide for Elastomers is used whenever possible. Teflon® is a registered trademark of Dupont.

Chemical Resistance Tables

The following is a representative list of fluids, manufacturers and a general guideline for the use and compatibility of Continental hose and fittings.

Rating Scale

E Excellent resistance **X** Not Recommended
G Good Resistance **-** Testing Recommended **Blank** No Data

Chemical Name	Hose								Fittings and Adapters				
	PTFE (Teflon®)	CR (Polychloroprene)	NBR (Nitrile)	Nitrile / PVC	CPE	CSM	Urethane	Nylon	Carbon Steel	Stainless Steel 304	Stainless Steel 316	Aluminum	Brass
Pyrogard 51, 53, 55		-	X	-	-	-	-	-	E	E	E	-	-
Pyrogard C, D	E	-	E	-	-	-	G	E	E	E	E	E	E
Pyrolube		E	X	-	-	-	-	-	-	-	-	-	-
Quench Oil	E	G	G	-	-	-	-	-	-	E	E	E	-
Quintolubric 700													
Quintolubric 822		X	E	-	-	-	-	-	E	E	E	E	E
Quintolubric 957, 958													
Ramrod (Ag Spray)		-	-	-	-	-	-	E	E	E	E	E	E
Rando Oils		-	E	-	-	-	G	E	E	E	E	E	E
Rape Seed Oil		G	X	-	-	X	-	G	E	E	E	E	E
Red Line 100 Oil	E	G	E	-	-	-	-	-	-	-	-	-	-
Red Oil (Comm. Oleic Acid, MIL-H-5606)	E	G	G	G	E	G	-	E	G	G	E	E	G
Refined Wax (Petroleum)		G	E	G	-	-	G	E	E	E	E	-	E
Refrigerant Freon 113 (see Freon)			Use Freon Hose Only							Use Freon Hose Only			
Refrigerant Freon 114 (see Freon)			Use Freon Hose Only							Use Freon Hose Only			
Refrigerant Freon 12 (see Freon)			Use Freon Hose Only							Use Freon Hose Only			
Refrigerant Freon 22 (see Freon)			Use Freon Hose Only							Use Freon Hose Only			
Refrigerant Freon 502 (see Freon)			Use Freon Hose Only							Use Freon Hose Only			
Refrigerant HFC 134A (see Freon)			Use Freon Hose Only							Use Freon Hose Only			
Regal Oils R&O		-	E	-	-	-	G	E	-	-	-	-	-
Resorcinol													
Richfield Weed Killer		X	G	-	-	X	-	-	-	-	-	-	-
Round Up		G	G	-	-	-	-	E	G	E	E	E	E
Rubilene Oils		-	E	-	-	-	G	E	-	-	-	-	-
SAE N° 10 Oil	E												
Safco-Safe T10, T20													
Safetytex 215		-	X	-	-	-	-	-	-	-	-	-	-
Salicylic Acid (to 400°F)	E	E	X	-	-	-	-	E	E	E	E	G	-
Salt Water (see Water)	E	G	G	G	-	G	E	E	G	E	E	X	G
Santosafe 300		X	X	-	-	-	-	-	E	E	E	E	-
Santosafe W-G15, W-G20, W-G30		-	E	-	-	-	G	E	E	E	E	E	E
SCC 7204 (Stauffer)		-	-	-	-	-	-	-	-	-	-	-	-
Sevin		-	-	-	-	-	-	E	-	-	-	-	-
Sewage	E	G	G	G	E	G	-	E	X	E	E	G	G
Shell IRUS 902	E												
Shell IRUS 905	E												
Shell Pella-A													

Underline is cover compound rating only. Many factors, such as temperature, concentration and length of exposure, are relevant to how chemical exposure affects the tube and cover or fitting material. The fluid manufacturer's recommended maximum operating temperature should be carefully observed. Exceeding the manufacturer's recommended maximum temperature can result in fluid breakdown and cause harm or shorten the life of tube and cover materials. There may be instances where the hose cover could be adversely affected by fluids which would not chemically affect the hose tube. Conversely, some fluids with an adverse affect on the tube of the hose may not have a deteriorating effect on the hose cover. It is recommended that the user test the hose/fluid compatibility to their own standards. Since no industry standards exist for chemical resistance, the Compass Chemical Resistance Guide for Elastomers is used whenever possible. Teflon® is a registered trademark of Dupont.

Chemical Resistance Tables

The following is a representative list of fluids, manufacturers and a general guideline for the use and compatibility of Continental hose and fittings.

Rating Scale

- E** Excellent resistance
- G** Good Resistance
- X** Not Recommended
- Testing Recommended
- Blank** No Data

Chemical Name	Hose								Fittings and Adapters				
	PTFE (Teflon®)	CR (Polychloroprene)	NBR (Nitrile)	Nitrile / PVC	CPE	CSM	Urethane	Nylon	Carbon Steel	Stainless Steel 304	Stainless Steel 316	Aluminum	Brass
Shell Tellus													
Shellac (to 400°F)		G	E	-	-	-	-	E	E	E	E	E	-
Shellac (Bleached) (to 400°F)	E	G	E	-	-	-	-	E	E	E	E	E	G
Shellac (Orange) (to 400°F)	E	G	E	-	-	-	-	E	E	E	E	E	G
Silicate Ester (to 400°F)	E												
Silicone Greases	E	G	G	G	-	G	-	E	E	E	E	E	E
Silicone Oils	E	G	G	G	-	G	-	E	E	E	E	E	E
Silver Cyanide	E	E	-	-	-	-	-	-	E	E	E	X	-
Silver Nitrate	E	E	E	E	E	E	-	E	G	E	E	E	G
Skelly, Solvent B, C, E		X	E	-	-	-	-	-	-	-	-	-	-
Skydrol 500A & 7000 (to 200°F)	E	X	X	X	G	X	-	E	E	E	E	E	-
Soap oil	E	X	X	-	-	X	-	-	E	E	E	-	-
Soap Solutions	E	G	E	G	E	E	E	E	E	E	E	E	E
Soda Ash (Sodium Carbonate)	E	E	E	E	E	E	E	E	E	E	E	X	G
Soda Water	E	-	-	-	-	-	E	E	-	-	-	-	-
Sodium Dichromate		G	E	-	E	G	E	E	-	-	-	-	-
Sodium Hypochlorite 100% (to 200°F)	E	E	X	-	-	-	-	-	X	X	X	X	-
Sodium Hypochlorite 20% (to 400°F)	E	X	X	X	E	E	X	E	X	X	G	X	X
Sodium Hypochlorite 5%	E	-	X	X	E	E	X	E	X	X	G	X	X
Sodium Hyposulfate	E	X	-	-	-	-	-	-	X	E	E	X	-
Sodium Metaphosphate	E	G	G	G	E	G	-	E	X	E	E	E	X
Sodium Nitrate	E	X	X	-	E	G	E	E	E	G	G	G	G
Sodium Perborate	E	X	X	-	-	X	-	G	X	E	E	E	X
Sodium Peroxide (Sodium Dioxide)	E	E	G	E	G	E	-	X	X	E	E	E	X
Sodium Phosphate	E	X	E	-	E	-	E	E	G	E	E	X	X
Sodium Phosphate (Dibasic)	E	G	E	-	-	-	-	-	-	-	-	-	-
Sodium Phosphate (Mono)	E	E	E	-	-	-	-	-	-	-	-	-	-
Sodium Phosphate (Tribasic)		G	E	-	-	-	-	-	G	G	G	-	-
Sodium Silicate		E	E	-	E	E	G	E	G	G	G	X	X
Sodium Silicate (Hot)	E	E	E	-	-	-	-	-	G	G	G	X	X
Sodium Sulfate	E	E	E	-	E	E	E	E	G	E	E	-	G
Sodium Sulfide	E	E	E	-	E	E	E	E	X	X	G	X	X
Sodium Sulfide Saturated 100%	E	E	E	-	-	-	-	E	G	G	E	X	X
Sodium Sulfite		G	G	G	E	G	E	G	E	E	E	-	X
Sodium Sulfite 10% at 150°F		E	E	-	-	-	-	-	G	G	G	G	-
Sodium Sulfite 5%		E	E	-	-	-	-	-	E	E	E	E	-

Underline is cover compound rating only. Many factors, such as temperature, concentration and length of exposure, are relevant to how chemical exposure affects the tube and cover or fitting material. The fluid manufacturer's recommended maximum operating temperature should be carefully observed. Exceeding the manufacturer's recommended maximum temperature can result in fluid breakdown and cause harm or shorten the life of tube and cover materials. There may be instances where the hose cover could be adversely affected by fluids which would not chemically affect the hose tube. Conversely, some fluids with an adverse affect on the tube of the hose may not have a deteriorating effect on the hose cover. It is recommended that the user test the hose/fluid compatibility to their own standards. Since no industry standards exist for chemical resistance, the Compass Chemical Resistance Guide for Elastomers is used whenever possible. Teflon® is a registered trademark of Dupont.

Chemical Resistance Tables

The following is a representative list of fluids, manufacturers and a general guideline for the use and compatibility of Continental hose and fittings.

Rating Scale

E Excellent resistance	X Not Recommended
G Good Resistance	- Testing Recommended
Blank No Data	

Chemical Name	Hose								Fittings and Adapters				
	PTFE (Teflon®)	CR (Polychloroprene)	NBR (Nitrile)	Nitrile / PVC	CPE	CSM	Urethane	Nylon	Carbon Steel	Stainless Steel 304	Stainless Steel 316	Aluminum	Brass
Sodium Thiosulfate (HPO, Antichlor)	E	E	E	E	E	E	E	E	X	E	E	G	X
Sodium Tripolyphosphate (STPP) (to 70°F)	E	-	-	-	-	-	-	-	-	E	E	X	X
Sodium Acetate	E	X	X	X	E	X	G	E	E	E	E	E	E
Sodium Benzoate	E	-	-	-	-	-	E	-	-	-	-	-	-
Sodium Bicarbonate	E	E	E	E	E	E	E	E	G	E	E	G	G
Sodium Bisulfate (Niter Cake)		E	E	E	E	E	E	E	X	G	E	X	X
Sodium Bisulfite	E	E	E	E	E	E	E	E	G	E	E	G	-
Sodium Borate	E	E	E	E	E	E	E	E	E	E	E	-	-
Sodium Carbonate	E	E	E	E	E	E	E	E	G	G	G	X	G
Sodium Chlorate	E	G	E	-	-	E	E	E	G	G	G	X	-
Sodium Chloride	E	E	E	E	E	E	E	E	G	G	E	X	X
Sodium Chloride - 2%	E	E	E	-	-	-	-	E	G	G	E	X	X
Sodium Chloride - 5%	E	E	E	-	-	-	-	E	-	G	E	X	X
Sodium Chloride - 5% at 150°F	E	E	E	-	-	-	-	E	-	G	E	-	X
Sodium Chloride Saturated	E	E	E	-	-	-	-	E	-	E	E	X	-
Sodium Chloride Saturated (Boiling)	E	-	-	-	-	-	-	-	-	G	E	X	-
Sodium Chloride Slurry		-	-	-	-	-	-	-	-	-	-	-	-
Sodium Cyanide	E	E	E	E	E	E	E	E	G	E	E	X	X
Sodium Ferricyanide	E	-	-	-	-	-	-	-	G	G	G	-	-
Sodium Ferrocyanide	E	-	-	-	-	-	-	-	-	-	-	-	-
Sodium Fluoride	E	-	E	-	-	-	-	-	G	G	G	-	-
Sodium Fluoride (5%)	E	-	E	-	-	-	-	E	G	G	G	-	-
Sodium Fluoride (70%)	E	-	-	-	-	-	-	-	-	-	G	-	-
Sodium Hydrosulfide - 100% (to 70°F)	E	E	X	-	-	-	-	-	-	-	-	-	-
Sodium Hydrosulfide - 45% (to 500°F)	E	E	X	-	-	-	-	-	-	-	-	-	-
Sodium Hydrosulfite	E	-	-	-	-	-	-	-	-	-	-	-	-
Sodium Hydroxide	E	G	G	-	-	-	-	-	G	-	-	-	X
Sodium Hydroxide (10%)	E	-	-	-	E	-	-	-	-	-	-	-	-
Sodium Hydroxide (20% Cold)	E	E	G	-	-	-	-	E	E	E	E	X	X
Sodium Hydroxide (20% Hot)	E	E	X	-	-	-	-	-	G	E	E	X	X
Sodium Hydroxide (3M)		G	G	-	-	-	-	-	-	-	-	-	X
Sodium Hydroxide (40%)	E	E	G	G	E	E	-	G	G	E	E	X	X
Sodium Hydroxide (50% Cold)	E	G	X	X	E	E	-	G	G	G	G	X	X
Sodium Hydroxide (50% Hot)	E	-	-	-	E	G	-	X	X	G	G	X	X
Sodium Hydroxide (60%)	E	G	X	X	E	G	-	X	X	G	G	X	X
Sodium Hydroxide (70% Cold)	E	E	G	-	-	-	-	-	-	-	G	X	X

Underline is cover compound rating only. Many factors, such as temperature, concentration and length of exposure, are relevant to how chemical exposure affects the tube and cover or fitting material. The fluid manufacturer's recommended maximum operating temperature should be carefully observed. Exceeding the manufacturer's recommended maximum temperature can result in fluid breakdown and cause harm or shorten the life of tube and cover materials. There may be instances where the hose cover could be adversely affected by fluids which would not chemically affect the hose tube. Conversely, some fluids with an adverse affect on the tube of the hose may not have a deteriorating effect on the hose cover. It is recommended that the user test the hose/fluid compatibility to their own standards. Since no industry standards exist for chemical resistance, the Compass Chemical Resistance Guide for Elastomers is used whenever possible. Teflon® is a registered trademark of Dupont.

Chemical Resistance Tables

The following is a representative list of fluids, manufacturers and a general guideline for the use and compatibility of Continental hose and fittings.

Rating Scale

E Excellent resistance **X** Not Recommended
G Good Resistance **-** Testing Recommended **Blank** No Data

Chemical Name	Hose								Fittings and Adapters				
	PTFE (Teflon®)	CR (Polychloroprene)	NBR (Nitrile)	Nitrile / PVC	CPE	CSM	Urethane	Nylon	Carbon Steel	Stainless Steel 304	Stainless Steel 316	Aluminum	Brass
Sodium Hydroxide (70% Hot)	E	-	-	-	-	-	-	-	-	-	-	-	-
Sodium Hydroxide (80% Hot)	E	E	X	-	-	-	-	-	X	X	X	X	X
Sole													
Solnus Oils		-	E	-	-	-	G	E	E	E	E	E	E
Solvac 1535 G		-	-	-	G	-	-	E	-	-	-	-	-
Sour Crude Oil		-	-	-	-	-	-	-	-	-	-	-	-
Soybean Oil	E	G	G	G	-	G	-	E	E	E	E	E	-
Spent Acid		-	-	-	-	G	-	-	-	E	E	-	-
SR-10 Fuel		X	G	-	-	-	-	-	-	-	-	-	-
SR-6 Fuel		X	E	-	-	-	-	-	-	-	-	-	-
SRF Fluid B (Shell)		-	X	-	-	-	-	-	-	-	-	-	-
SRF Fluid C (Shell)		-	X	-	-	-	-	-	-	-	-	-	-
Stannic Chloride	E	X	G	G	E	X	-	X	X	X	X	X	X
Stannic Chloride (50%)	E	X	E	-	-	-	-	-	X	X	X	X	-
Stannous Chloride (Under 150°F)	E	E	E	-	E	E	-	X	-	X	G	X	-
Stannous Chloride, 15%	E	E	E	-	-	-	-	-	X	X	-	X	-
Stanoil N° 15, 18, 25, 31, 35, 51		-	E	-	-	-	G	E	E	E	E	E	E
Starch	E	G	G	-	-	E	E	E	X	E	E	E	-
Staysol FR		-	E	-	-	-	G	E	E	E	E	E	E
Steam-Water up to 250°F	E												
Stearic Acid	E	G	G	G	E	G	E	E	X	G	E	X	X
Stearin		-	-	-	-	-	E	G	-	-	-	-	-
Stoddard Solvent	E	G	G	X	E	-	X	E	G	E	E	E	E
Styrene (Monomer)	E	-	X	-	G	-	-	G	G	X	G	X	G
Styrene (Vinyl Benzene)		X	X	-	-	-	-	E	E	E	E	E	E
Sucrose Solutions	E	E	E	E	-	E	-	-	E	E	E	-	-
Sulfamic Acid (10% Under 170°F)	E	-	-	-	E	G	-	-	-	-	-	-	-
Sulfate Black Liquor	E	E	E	-	-	-	-	E	G	G	G	X	-
Sulfate Green Liquor	E	E	E	-	-	-	-	E	G	G	G	X	-
Sulfur	E	-	-	-	-	-	-	-	-	-	-	-	-
Sulfur (Molten)		X	X	-	-	-	-	-	-	-	-	-	-
Sulfur Chloride	E	X	X	X	-	G	-	G	X	X	G	X	X
Sulfur Dioxide (Dry)	E	X	X	X	-	G	-	X	G	E	E	E	E
Sulfur Dioxide (Liquid)	E	G	X	-	-	G	-	-	-	-	-	-	-
Sulfur Dioxide (Moist)	E	G	X	-	-	G	-	E	-	G	E	E	X
Sulfur Hexafluoride (Gas) (to 70°F)	E	E	G	-	-	G	-	X	-	-	-	-	-
Sulfur Trioxide (Dry)	E	X	X	X	X	X	-	E	G	G	G	G	X
Sulfuric Acid (10%)	E	E	G	G	E	E	-	X	-	X	X	G	X

Underline is cover compound rating only. Many factors, such as temperature, concentration and length of exposure, are relevant to how chemical exposure affects the tube and cover or fitting material. The fluid manufacturer's recommended maximum operating temperature should be carefully observed. Exceeding the manufacturer's recommended maximum temperature can result in fluid breakdown and cause harm or shorten the life of tube and cover materials. There may be instances where the hose cover could be adversely affected by fluids which would not chemically affect the hose tube. Conversely, some fluids with an adverse affect on the tube of the hose may not have a deteriorating effect on the hose cover. It is recommended that the user test the hose/fluid compatibility to their own standards. Since no industry standards exist for chemical resistance, the Compass Chemical Resistance Guide for Elastomers is used whenever possible. Teflon® is a registered trademark of Dupont.

Chemical Resistance Tables

The following is a representative list of fluids, manufacturers and a general guideline for the use and compatibility of Continental hose and fittings.

Rating Scale

E Excellent resistance **X** Not Recommended
G Good Resistance **-** Testing Recommended **Blank** No Data

Chemical Name	Hose								Fittings and Adapters				
	PTFE (Teflon®)	CR (Polychloroprene)	NBR (Nitrile)	Nitrile / PVC	CPE	CSM	Urethane	Nylon	Carbon Steel	Stainless Steel 304	Stainless Steel 316	Aluminum	Brass
Sulfuric Acid (30%)	E	E	-	-	E	E	-	X	X	X	G	X	X
Sulfuric Acid (50%)	E	G	X	X	E	E	-	X	X	X	G	X	X
Sulfuric Acid (75%)	E	X	X	X	-	G	-	X	X	X	G	X	X
Sulfuric Acid (93%)	E	X	X	X	-	X	-	X	G	X	G	X	X
Sulfuric Acid (98%)	E	X	X	X	X	X	-	X	G	X	G	X	X
Sulfuric Acid, 3 Molar		X	X	-	-	-	-	-	-	-	-	-	-
Sulfuric Acid, 85%	E	X	X	-	-	-	-	-	X	G	E	X	-
Sulfuric Acid, Aerated, No Velocity	E	-	-	-	-	-	-	-	G	G	G	X	-
Sulfuric Acid, Air Free, No Velocity	E	-	-	-	-	-	-	-	X	X	G	X	-
Sulfuric Acid, Concentrated	E	X	X	-	-	-	-	-	-	E	E	-	-
Sulfuric Acid, Fuming, Oleum (Permeable)	E	X	-	-	-	-	-	-	G	E	E	G	-
Sulfurous Acid	E	G	G	-	-	-	-	X	X	X	G	G	-
Sulfurous Acid (10%)	E	-	X	-	E	E	-	-	-	X	G	E	X
Sulfurous Acid (75%)	E	X	X	X	E	E	-	X	X	X	G	X	X
Sulphuric Acid (10%)		-	G	-	-	-	-	X	X	G	E	X	X
Sulphuric Acid (5%)		-	E	-	-	-	-	X	G	G	E	X	X
Sulphuric Acid (5% Boiling)		X	-	-	-	-	-	X	X	X	-	X	X
Sulphuric Acid (50%)		X	X	-	-	-	-	X	X	X	X	X	X
Sulphuric Acid, Concentrated		X	X	-	-	-	-	X	-	E	E	X	X
Sulphuric Acid, Concentrated at 300%		X	X	-	-	-	-	-	X	X	X	X	X
Sulphuric Acid, Concentrated Boiling		X	X	-	-	-	-	-	X	X	X	X	X
Sulphuric Acid, Fuming		X	-	-	-	-	-	-	G	G	G	X	-
Sulphuric Acid (10% Boiling)		X	X	-	-	-	-	X	X	X	-	X	X
Sulphurous Acid, Saturated		X	X	-	-	-	-	G	-	E	E	X	X
Sun Minesafe, Sunsafe													
Sun R&O Oils		-	E	-	-	-	G	E	E	E	E	E	E
Sunsafe (Fire Resistant Hydraulic Fluid) to 70°F	E	G	E	-	-	-	G	E	E	E	E	E	-
Suntac HP Oils		-	E	-	-	-	G	E	E	-	E	E	-
Suntac WR Oils		-	E	-	-	-	G	E	E	-	E	E	-
Sunvis Oils 700, 800, 900		-	E	-	-	-	G	E	E	E	E	-	-
Super Hydraulic Oils (Conoco)		-	E	-	-	-	G	E	E	E	E	E	-
Sutan Plus, Herbicide		X	X	X	E	-	-	E	E	E	E	E	-
Sutazine Plus, Herbicide		X	X	-	E	-	-	E	X	E	E	E	-
Synesstic													
Synthetic Oil (Citgo)		-	-	-	-	-	G	E	E	E	E	-	-
Syrup	E	G	E	G	-	-	-	E	-	E	E	E	-
Tall Oil (Under 100°F)	E	G	G	G	-	X	-	-	G	X	G	X	-

Underline is cover compound rating only. Many factors, such as temperature, concentration and length of exposure, are relevant to how chemical exposure affects the tube and cover or fitting material. The fluid manufacturer's recommended maximum operating temperature should be carefully observed. Exceeding the manufacturer's recommended maximum temperature can result in fluid breakdown and cause harm or shorten the life of tube and cover materials. There may be instances where the hose cover could be adversely affected by fluids which would not chemically affect the hose tube. Conversely, some fluids with an adverse affect on the tube of the hose may not have a deteriorating effect on the hose cover. It is recommended that the user test the hose/fluid compatibility to their own standards. Since no industry standards exist for chemical resistance, the Compass Chemical Resistance Guide for Elastomers is used whenever possible. Teflon® is a registered trademark of Dupont.

Chemical Resistance Tables

The following is a representative list of fluids, manufacturers and a general guideline for the use and compatibility of Continental hose and fittings.

Rating Scale

E Excellent resistance **X** Not Recommended
G Good Resistance **-** Testing Recommended **Blank** No Data

Chemical Name	Hose								Fittings and Adapters				
	PTFE (Teflon®)	CR (Polychloroprene)	NBR (Nitrile)	Nitrile / PVC	CPE	CSM	Urethane	Nylon	Carbon Steel	Stainless Steel 304	Stainless Steel 316	Aluminum	Brass
Tallow	E	G	G	G	-	-	-	E	G	G	G	E	G
Tannic Acid (10%)	E	G	X	-	E	G	-	X	G	E	E	G	X
Tannin		E	E	-	-	-	-	E	-	-	-	-	-
Tar (Bituminous, Under 100°F)	E	G	G	G	X	-	-	-	E	E	E	E	G
Tar and Tar Oil		G	-	-	-	-	G	E	E	E	E	E	G
Tartaric Acid	E	G	G	G	E	E	-	E	X	G	G	G	X
Tellus Oils (to 70°F)	E	-	E	-	-	-	G	E	E	E	E	E	E
Tenol Oils		-	E	-	-	-	G	E	E	E	E	-	-
Tergitol		-	-	-	-	-	-	-	G	E	E	-	G
Terpineol	E	X	G	-	E	G	-	G	E	E	E	E	-
Terresstic		-	E	-	-	-	-	E	E	E	E	-	-
Tertiary Butyl Alcohol													
Tetra Chloro Benzene													
Tetra Chloro Ethane	E												
Tetra Chloro Ethylene (Permeable)	E												
Tetra Chloro Methane	E												
Tetra Chloro Naphthalene													
Tetra Ethylene Glycol													
Tetraethyl Lead		G	G	-	-	-	-	G	-	-	-	-	-
Tetraethyl Lead Blench		X	G	-	-	-	-	-	-	-	-	-	-
Tetrahydrofuran (THF)		X	X	-	-	X	G	E	G	E	E	-	-
Tetralin		X	X	-	-	X	-	G	E	E	E	E	-
Texaco 760 Hydrafluid													
Texaco 766, 763 (200-300)													
Thiopen (to 70°F)	E	X	X	-	-	-	-	-	-	-	-	-	-
Tim-Sol													
Titanium Tetrachloride	E	X	X	X	-	-	-	-	E	G	G	X	X
Toluene (Toluol)	E	X	X	X	X	X	-	E	E	E	E	E	E
Toluene Diisocyanate (Under 150°F)	E	X	-	-	-	-	-	-	E	E	E	-	-
Transformer Oil (Askarel Types)		X	X	X	E	X	-	-	E	E	E	E	-
Transformer Oil (Petroleum Type)	E	G	E	G	E	X	G	E	E	E	E	E	E
Transmission Fluid Type A	E	G	E	G	E	G	-	G	E	E	E	E	E
Tributyl Phosphate	E	X	X	X	G	X	-	-	E	-	-	X	-
Tributoxyethyl Phosphate	E	X	X	X	X	X	-	G	E	-	-	X	-
Tributyl Phosphate	E												
Trichloro Acetic Aci	E												
Trichloro Etane (Permeable)	E												
Trichloroethylene (Permeable)	E	X	X	X	G	X	-	G	X	G	E	X	E

Underline is cover compound rating only. Many factors, such as temperature, concentration and length of exposure, are relevant to how chemical exposure affects the tube and cover or fitting material. The fluid manufacturer's recommended maximum operating temperature should be carefully observed. Exceeding the manufacturer's recommended maximum temperature can result in fluid breakdown and cause harm or shorten the life of tube and cover materials. There may be instances where the hose cover could be adversely affected by fluids which would not chemically affect the hose tube. Conversely, some fluids with an adverse affect on the tube of the hose may not have a deteriorating effect on the hose cover. It is recommended that the user test the hose/fluid compatibility to their own standards. Since no industry standards exist for chemical resistance, the Compass Chemical Resistance Guide for Elastomers is used whenever possible. Teflon® is a registered trademark of Dupont.

Chemical Resistance Tables

The following is a representative list of fluids, manufacturers and a general guideline for the use and compatibility of Continental hose and fittings.

Rating Scale

E Excellent resistance	X Not Recommended
G Good Resistance	- Testing Recommended
Blank No Data	

Chemical Name	Hose								Fittings and Adapters				
	PTFE (Teflon®)	CR (Polychloroprene)	NBR (Nitrile)	Nitrile / PVC	CPE	CSM	Urethane	Nylon	Carbon Steel	Stainless Steel 304	Stainless Steel 316	Aluminum	Brass
Trichloromonofluoroethane (Freon 113) (to 200°F)	E	-	E	-	-	-	-	-	E	E	E	X	-
Trichloromonofluoroethane (Freon 17) (to 200°F)	E	-	-	-	-	-	-	-	E	E	E	X	-
Tricresyl Phosphate	E	X	X	X	E	X	-	E	E	G	G	X	-
Triethanolamine (TEA)	E	G	G	-	E	G	-	E	E	E	E	E	E
Triphenyl Phosphate													
Tripolyphosphate (STPP)		X	E	-	-	-	-	-	-	G	E	X	-
Trisodium Phosphate E													
Tung Oil (to 400°F)	E	G	G	-	-	G	-	E	E	E	E	E	E
Turbine Oil #15 (MIL-L-7808A) (to 70°F)	E	X	E	-	-	-	-	-	E	E	E	E	-
Turbine Oil (to 250°F)	E	X	E	-	-	-	-	-	E	E	E	E	-
Turbo Oil #35		X	G	-	-	-	-	-	E	E	E	E	-
Turpentine	E	X	G	-	G	X	E	E	X	E	E	E	G
Tycol A Turbo 37, 50, 58, 60		-	E	-	-	-	G	E	E	E	E	-	-
Tycol Avalon 50, 57, 60		-	E	-	-	-	G	E	E	E	E	-	-
Type I Fuel (MIL-S-3136) ASTM Fuel A (to 300°F)	E	G	E	-	-	-	-	-	E	E	E	E	-
Type II Fuel (MIL-S-3136)		X	G	-	-	-	-	-	E	E	E	E	-
Type III Fuel (MIL-S-3136) ASTM Fuel B (to 300°F)	E	X	E	-	-	-	-	-	E	E	E	E	-
Ucon Hydrolube Types 150CP, 200CP		-	E	-	-	-	G	E	E	E	E	E	E
Ucon Hydrolube Types 275CP, 300CP, 550CP (to 70°F)	E	-	-	-	-	-	-	-	-	-	-	-	-
Ucon M1		-	E	-	-	-	G	E	E	E	E	E	E
Union ATF Dexron		-	E	-	-	-	G	E	E	E	E	E	E
Union ATF Type F		-	E	-	-	-	G	E	E	E	E	E	E
Union C-2 Fluid		-	E	-	-	-	G	E	E	E	E	E	E
Union C-P Oil		-	E	-	-	-	G	E	E	E	E	E	E
Union Hydraulic Oil AW		-	E	-	-	-	G	E	E	E	E	E	E
Union Hydraulic Tractor Fluid		-	E	-	-	-	G	E	E	E	E	E	E
Univis 40, Hydraulic Fluid		G	E	-	-	-	-	-	E	E	E	E	-
Unleaded Gasoline	E												
Urea Solution	E	E	G	-	E	E	G	E	E	E	E	G	-
Urethane Formulations													
Uric Acid (100%) (to 250°F)	E												
Uric Acid (75%) (to 400°F)	E												
Varnish	E	X	X	X	X	X	-	E	G	E	E	E	G
Vaseline	E												
Vegetable Oils	E	G	E	G	E	-	G	E	E	E	E	E	G
Vegetable Oils (Hot)	-	-	-	-	-	-	E	G	G	G	E	G	

Underline is cover compound rating only. Many factors, such as temperature, concentration and length of exposure, are relevant to how chemical exposure affects the tube and cover or fitting material. The fluid manufacturer's recommended maximum operating temperature should be carefully observed. Exceeding the manufacturer's recommended maximum temperature can result in fluid breakdown and cause harm or shorten the life of tube and cover materials. There may be instances where the hose cover could be adversely affected by fluids which would not chemically affect the hose tube. Conversely, some fluids with an adverse affect on the tube of the hose may not have a deteriorating effect on the hose cover. It is recommended that the user test the hose/fluid compatibility to their own standards. Since no industry standards exist for chemical resistance, the Compass Chemical Resistance Guide for Elastomers is used whenever possible. Teflon® is a registered trademark of Dupont.

Chemical Resistance Tables

The following is a representative list of fluids, manufacturers and a general guideline for the use and compatibility of Continental hose and fittings.

Rating Scale

E Excellent resistance

X Not Recommended

G Good Resistance

- Testing Recommended

Blank No Data

Chemical Name	Hose								Fittings and Adapters				
	PTFE (Teflon®)	CR (Polychloroprene)	NBR (Nitrile)	Nitrile / PVC	CPE	CSM	Urethane	Nylon	Carbon Steel	Stainless Steel 304	Stainless Steel 316	Aluminum	Brass
Versilube	E	E	E	-	-	-	-	-	E	E	E	E	-
Versilube F-50, F-44 (to 70°F)	E	G	G	G	-	G	G	E	E	E	E	E	E
Vinyl Acetate	E	X	X	X	E	X	-	-	G	E	G	E	G
Vinyl Chloride (Chloroethylene, Monomer) (Permeable)	E	X	X	X	X	X	-	-	G	E	E	G	X
Vital 4300, 5310													
Vitrea Oils		-	E	-	-	-	G	E	E	E	E	-	-
Volt Esso 35													
Water	E	E	E	E	E	E	E	E	E	E	E	E	E
Water Glycols	E												
Water in Oil Emulsion		-	-	-	-	-	G	E	-	-	-	-	-
Water (Under 150°F)	E												
Water (Up to 200°F)	E												
Water, Acid Mine	E	G	X	-	-	-	-	E	X	G	G	X	X
Water, Brine		G	G	-	-	E	E	E	X	G	G	-	-
Water, Demineralized	E	-	-	-	-	-	-	-	-	-	-	-	E
Water, Distilled	E	G	E	-	-	E	E	E	X	E	E	E	
Water, Fresh	E	E	E	-	-	-	-	E	X	E	E	E	-
Water, Potable (FDA Tube Only)	E		Use FDA Hose only						E				
Water, Salt	E	G	E	-	-	-	-	E	X	G	G	X	
Whiskey	E											X	
White & Bagley N° 2190 Cutting Oil		G	E	-	-	-	-	-	-	-	-	-	-
White Oil (to 70°F)	E												-
White Pine Oil												X	
Wines	E		Use FDA Hose only										
Wood Alcohol													
Wood Oil (to 400°F)	E	G	E	-	E	G	E	E	E	E	E	E	
Xenon	E												
Xylene, Xylol	E	X	E	-	X	-	G	G	G	G	G	E	
Xylidine													
Zeric		-	E	-	-	-	G	G	-	-	-	-	-
Zinc Acetate	E	G	X	-	-	X	-	G	E	E	E	E	
Zinc Carbonate (to 200°F)	E												
Zinc Chloride Solutions	E	E	E	E	E	E	-	E	X	G	E	X	
Zinc Chromate 75% (to 400°F)	E	-	-	-	E	E	-	-	-	E	E	-	
Zinc Hydrate		-	-	-	-	-	G	-	-	-	-	-	
Zinc Sulfate Solutions (to 300°F)	E	G	G	G	E	G	-	G	X	G	E	X	

Underline is cover compound rating only. Many factors, such as temperature, concentration and length of exposure, are relevant to how chemical exposure affects the tube and cover or fitting material. The fluid manufacturer's recommended maximum operating temperature should be carefully observed. Exceeding the manufacturer's recommended maximum temperature can result in fluid breakdown and cause harm or shorten the life of tube and cover materials. There may be instances where the hose cover could be adversely affected by fluids which would not chemically affect the hose tube. Conversely, some fluids with an adverse affect on the tube of the hose may not have a deteriorating effect on the hose cover. It is recommended that the user test the hose/fluid compatibility to their own standards. Since no industry standards exist for chemical resistance, the Compass Chemical Resistance Guide for Elastomers is used whenever possible. Teflon® is a registered trademark of Dupont.

Design Considerations

Association for Rubber Products Manufacturers Design Considerations

Reprinted from ARPM Hose Handbook (IP-2-2015)

Design Ratio

A ratio used to establish the working pressure of the hose, based on the burst strength of the hose.

Design Considerations

In designing hose, it is customary to develop a design ratio, which is the ratio between the minimum burst pressure and the maximum working pressure (WP).

Burst test data is compiled, and the minimum value is established by accepted statistical techniques. This is done as a check on theoretical calculations, based on the strength of reinforcing materials and on the characteristics of the method of fabrication.

Minimum burst values are used as one factor in establishing a reasonable and safe maximum working pressure.

Maximum Working Pressure is One of the Essential Operating Characteristics that a Hose User Must Know and Respect to Assure Satisfactory Service and Optimum Life.

It should be noted that design ratios are dependent on more than the minimum burst value. The hose technologist must anticipate natural decay in the strength of reinforcing materials, the accelerated decay induced by the anticipated environments in which the hose will be used and the dynamic situations that a hose might likely encounter in service.

Including all considerations, the following design ratios should be considered minimum requirements for newly manufactured hose:

Ratio	Hose Type
2:1	Hose for the delivery of cement, concrete, plaster and grout designed to ASME B30.27
3:1	Water hose up to 1 MPa (150 psi) WP
4:1	Hose for all other liquids, solid materials suspended in liquids or air and water hose over 1 MPa (150 psi) WP
	Hose for compressed air and other gases
5:1	Hose for liquid media that immediately changes into gas under standard atmospheric conditions
10:1	Steam hose

Standards Certifications



Compliant with standards and accepted practices designed by industry experts for the sanitary design, fabrication, installation and cleanability of dairy and food equipment or systems used to handle, process and package consumable products where a high degree of sanitation is required to prevent contamination.



A classification society, with a mission to promote the security of life, property and the natural environment, primarily through the development and verification of standards for the design, construction and operational maintenance of marine-related facilities.



A non-profit organization that oversees the development of voluntary consensus standards for products, services, processes, systems and personnel in the U.S. They also coordinate U.S. standards with international standards so that American products can be used worldwide. ANSI accredits standards that are developed by representatives of other standards organizations, government agencies, consumer groups, companies and others. These standards ensure that the characteristics and performance of products are consistent, that people use the same definitions and terms and that products are tested the same way.



The largest U.S. trade association for the oil and natural gas industry. It functions on behalf of the industry in the establishment and certification of industry standards.



Its core mission has been designed to provide waste reduction, benchmarking, networking, international management of product standards and educational opportunities to its member executives.



ASME is one of the oldest standards-developing organizations in America. It produces approximately 600 codes and standards covering many technical areas, such as fasteners, plumbing fixtures, elevators, pipelines and power plant systems and components. ASME standards are developed by committees of subject matter experts using an open, consensus-based process. Many ASME standards are cited by government agencies as tools to meet their regulatory objectives. ASME standards are therefore voluntary unless the standards have been incorporated into a legally binding business contract or incorporated into regulations enforced by an authority having jurisdiction, such as a federal, state or local government agency. ASME's standards are used in more than 100 countries.



An international standards organization that develops and publishes voluntary consensus technical standards for a wide range of materials, products, systems and services. Some 12,575 ASTM voluntary consensus standards operate globally.



The German Federal Institute for Risk Assessment approved list of natural and synthetic rubbers and their requirements to be used in food commodities.

Standards Certifications



Standards are produced by the BSI Group which is incorporated under a Royal Charter. The BSI Group produces British Standards under the authority of the Charter, which lays down as one of the BSI's objectives to set up standards of quality for goods and services. They also prepare and promote the general adoption of British Standards and schedules in connection therewith and from time to time to revise, alter and amend such standards and schedules as experience and circumstances require.



An international certification agency. In addition to certifications, they provide health, safety and environmental (HSI) expertise.



Meets the standard set by the California Air Resource Board for low permeation performance and is compatible with the Assist Phase II EVR Systems.



The CE marking indicates that the manufacturer or importer claims compliance with the relevant EU legislation applicable to a product, regardless of where it's manufactured. By affixing the CE marking on a product, a manufacturer is declaring, as its sole responsibility, conformity with all of the legal requirements to achieve CE marking. This allows free movement and sale of the product throughout the European Economic Area.



The Compressed Gas Association is an ANSI-accredited standards developing organization working directly with federal, state and provincial agencies to promote safe and responsible practices and regulations. They establish safety standards, safety information and warnings about the chemical or physical properties of gases and their containers.



CSA is authorized by the Canadian government to approve and certify electrical products in accordance with the "Canadian Electrical Code." A CSA-listed product means a product has been tested and meets applicable standards for safety and/or performance, including the applicable standards written or administered by the American National Standards Institute (ANSI), Underwriters Laboratories (UL), Canadian Standards Association (CSA), NSF International (NSF) and others.



Standard requirements cover hose and hose assemblies, including vapor recovery hose and assemblies, for use on dispensing devices for flammable liquids. A flammable liquid (gasoline and diesel) hose assembly consists of flexible hose and fittings suitable for attachment to flammable liquid-dispensing equipment. The term "gasoline" includes gasoline with small amounts of additives such as detergents, solvents for detergents, anti-icing chemicals and gasoline with up to 15 percent ethanol. Meets Canadian safety requirements for electrical code.



An international accredited registrar and classification society providing services for several industries including maritime, renewable energy, oil and gas, electrification, food and beverage and healthcare. It is also the largest technical consultancy and supervisory to the global renewable energy (particularly wind, wave, tidal and solar) and oil and gas industry—65% of the world's offshore pipelines are designed and installed to DNV GL's technical standards.

Standards Certifications



An agency of the federal government of the United States which was created for the purpose of protecting human health and the environment by writing and enforcing regulations based on laws passed by Congress. It has the responsibility of maintaining and enforcing national standards under a variety of environmental laws, in consultation with state, tribal and local governments. It delegates some permitting, monitoring and enforcement responsibility to U.S. states and the federally recognized tribes.



Hose composition consists of Food and Drug Administration-approved materials for use in the direct contact of food products.



The International Organization for Standardization is an independent, non-government organization made up of the standards organizations of 163 member countries. It is the world's largest developer of voluntary international standards and facilitates world trade by providing common standards between nations. Over twenty thousand standards have been set, covering everything from manufactured products and technology to food safety, agriculture and healthcare. Use of the standards aids in the creation of products and services that are safe, reliable and of good quality. The standards help businesses increase productivity while minimizing errors and waste. By enabling products from different markets to be directly compared, they facilitate companies in entering new markets and assist in the development of global trade on a fair basis. The standards also serve to safeguard consumers and the end-users of products and services, ensuring that certified products conform to the minimum standards set internationally.



A technical and business services organization and a maritime classification society dedicated to research and education in the science of engineering. They look to enhance the safety of life, property and the environment by helping clients to ensure the quality construction and operation of critical infrastructure.



Meets the guidelines set by the Mine Safety and Health Administration to ensure the safety and health of users while using products in a mining application.



Professional organization for the corrosion industry publishing standard practice, test method and material requirements standards for use by industry and other corrosion societies.



Promotes highly professional business and product standards and ethical conduct in dealing with customers, suppliers and competitors. Includes companies worldwide and engages in the distribution and manufacture of all types of hose, tubing, couplings, fittings, clamps and related accessories serving the industrial marketplace.



American industry trade association serving as a forum where all fluid power channel partners work together to advance fluid power technology, strengthen the fluid power industry and foster members' success.

Standards Certifications



If you manufacture, sell or distribute water treatment or distribution products in North America, your products are required to comply with NSF/ANSI 61: Drinking Water System Components - Health Effects by most governmental agencies that regulate drinking water supplies.



Voluntary association of oil companies that have an interest in the shipment and terminalling of crude oil and oil products. Their mission is to be the foremost authority on the safe and environmentally responsible operation of oil tankers and terminals, promoting continuous improvement in standards of design and operation.



Leading trade association for the United Kingdom's offshore oil and gas industry. They develop and deliver industry-wide initiatives and programs engaging with governments and other external organizations.



Ratings are determined on two factors, permeability and fire resistance. Particularly with volatile gasoline, permeability is a concern due to vapor buildup. This rating system is used exclusively for marine hose and it provides the following grades: A1—fuel feed hose has a fire-resistant cover, is designed to have fuel in the hose at all times and is the least permeable with the highest fire resistance. A2—fuel vent hose has a fire resistant cover, is not designed to have fuel in the hose at all times. B1—fuel feed hose; without fire resistant cover; is designed to have fuel in the hose at all times and is intended for non-enclosed spaces. Is intended for diesel engines or above-deck outboard gasoline applications. B2—fuel vent hose, without fire-resistant cover, is not designed to have fuel in the hose at all times. Is intended for diesel vent lines.



UL is the leading organization for “electrical safety” in the U.S., an important member of all boards of the “National Electrical Code” and substantially involved in harmonizing international IEC standards. The UL-listed products means that UL has tested and evaluated representative samples of that product and determined that they meet UL requirements.



Follows federal regulations for marine components safety requirements.



Hose meets the guidelines set by the U.S. Department of Agriculture to convey food products safely by being FDA certified.



A federal Cabinet department of the U.S. government concerned with transportation. Its mission is to serve the United States by ensuring a fast, safe, efficient, accessible and convenient transportation system that meets the vital national interests and enhances the quality of life of the American people, today and into the future.



Hose that meets the guidelines set by U.S. Pharmacopeial Convention to maintain the purity and quality of product being conveyed.

Hose Testing Methods

Reprinted from ARPM Hose Handbook (IP-2-2015)

Safety Warning

Testing can be dangerous and should be done only by trained personnel using proper tools and procedures. Failure to follow such procedures might result in damage to property and/or serious bodily injury.

The Association for Rubber Products Manufacturers (ARPM) recognizes, accepts and recommends the testing methods of the American Society for Testing and Materials (ASTM).

Unless otherwise specified, all hose tests are to be conducted in accordance with ASTM Method No. D-380 (latest revision). Where an ASTM D-380 test is not available, another test method should be selected and described in detail.

ARPM participates with ASTM under the auspices of the American National Standards Institute (ANSI) in Technical Committee 45 (TC45) of The International Organization for Standardization (ISO) in developing both hose product and hose test method standards. Many of the hose test method standards published by ISO duplicate or closely parallel those shown in ASTM D-380. Many are unique and, in those cases, the ARPM may be able to provide the necessary test standard references which may be purchased from the ANSI.

Hydrostatic Pressure Tests

Hydrostatic pressure tests are classified as follows:

1. **Destructive Type**
 - a. **Burst Test**
 - b. **Hold Test**

Destructive Tests

Destructive tests are conducted on short specimens of hose, normally 18 inches (460 mm) to 36 inches (915 mm) in length—and, as the name implies, the hose is destroyed in the performance of the test.

- a. **Burst Test** - Burst pressure is recorded as the pressure at which actual rupture of a hose occurs
- b. **Hold Test** - A hold test, when required, is a means of determining whether weakness will develop under a given pressure for a specified period of time

2. **Non-Destructive Type**
 - a. **Proof Pressure Test**
 - b. **Change in Length Test (Elongation or Contraction)**
 - c. **Change in Outside Diameter or Circumference Test**
 - d. **Warp Test**
 - e. **Rise Test**
 - f. **Twist Test**
 - g. **Kink Test**
 - h. **Volumetric Expansion Test**

Non-Destructive Tests continued on the next page.

Hose Testing Methods

Hydrostatic Pressure Tests

Non-Destructive Tests *Continued*

Non-destructive tests are conducted on a full length of a hose or hose assembly. These tests are for the purpose of eliminating hose with defects that cannot be seen by visual examination or are used in order to determine certain characteristics of the hose while it is under internal pressure.

- a. **Proof Pressure Test** - A proof pressure test is normally applied to hose for a specified period of time. On new hose, the proof pressure is usually 50% of the minimum specified burst except for woven jacket fire hose where the proof pressure is twice the service test pressure marked on the hose (67% of specified minimum burst). Hydrostatic tests performed on fire hose in service should be no higher than the service test pressure referred to above. The regulation of these pressures is extremely important so that no deteriorating stresses will be applied, thus weakening a normal hose.
- b. **Change in Length Test** - With some type of hose, it is useful to know how a hose will act under pressure. All change in length tests, except when performed on wire braid or wire-spiraled hose, are made with original length measurements taken under a pressure of 10 psi (0.069 MPa). The specified pressure, which is normally the proof pressure, is applied and immediate measurement of the characteristics desired are taken and recorded.

Percent length change (elongation or contraction) is the difference between the length at 10 psi (0.069 MPa) (except wire-braided or wire-spiraled) and that of the proof pressure times 100 divided by the length at 10 psi (0.069 MPa). Elongation occurs if the length of the hose under the proof pressure is greater than at a pressure of 10 psi (0.069 MPa). Contraction occurs if the length at the proof pressure is less than at 10 psi (0.069 MPa). In testing wire-braided or spiraled hose, the proof pressure is applied and the length recorded. The pressure is then released and, at the end of 30 seconds, the length is measured; the measurement obtained is termed the "original length."
- c. **Change in Outside Diameter Test** - Percent change in outside diameter or circumference is the difference between the outside diameter or circumference at 10 psi (0.069 MPa) and is obtained under the proof pressure times 100 divided by the outside diameter or circumference at 10 psi (0.069 MPa). Expansion occurs if the measurement at the proof pressure is greater than at 10 psi (0.069 MPa). Contraction occurs if the measurement at the proof pressure is less than 10 psi (0.069 MPa).
- d. **Warp Test** - Warp is the deviation from a straight line drawn from fitting to fitting; the maximum deviation from this line is warp. First, a measurement is taken at 10 psi (0.069 MPa) and then again at the proof pressure. The difference between the two, in inches, is the warp. Normally this is a feature measured on woven jacket fire hose only.
- e. **Rise Test** - Rise is a measure of the height a hose rises from the surface of the test table while under pressure. The difference between the rise at 10 psi (0.069 MPa) and at the proof pressure is reported to the nearest 0.25 inch (6.4 mm). Normally, this is a feature measured on woven jacket fire hose only.
- f. **Twist Test** - Twist is a rotation of the free end of the hose while under pressure. A first reading is taken at 10 psi (0.069 MPa) and a second reading at proof pressure. The difference, in degrees, between the 10 psi (0.069 MPa) base and that at the proof pressure is the twist. Twist is reported as right twist (to tighten couplings) or left twist. Standing at the pressure inlet and looking toward the free end of a hose, a clockwise turning is "right twist" and counterclockwise is "left twist."
- g. **Kink Test** - A measure of the ability of a woven jacket hose to withstand a momentary pressure while the hose is bent back sharply on itself at a point approximately 18 inches (457 mm) from one end. The test is made at pressures ranging from 62% of the proof pressure on sizes 3 inches (76 mm) and 3.5 inches (89 mm) to 87% on sizes under 3 inches (76 mm). This is a test applied to woven jacket fire hose only.
- h. **Volumetric Expansion Test** - Volumetric expansion test is applicable only to specific types of hose, such as hydraulic or power steering hose, and is a measure of its volumetric expansion under ranges of internal pressure.

Electrical Resistance Tests

For Hose and Hose Assemblies

1.0 Purpose

This procedure specifies methods for performing electrical resistance tests on rubber and/or plastic hose and hose assemblies.

2.0 Scope

These procedures are intended to test electrical conductive, antistatic and non-conductive (insulating) hose, along with electrical continuity or discontinuity between fittings.

Safety Warning

Hydraulic hose used on power and telephone mobile equipment should be tested to SAE 100R8 requirements.

3.0 Definitions

3.1 Antistatic Hose - Antistatic hose constructions are those that are capable of dissipating the static electricity buildup that occurs during the high-velocity flow of material through a hose.

3.2 Conductive Hose - Conductive hose constructions are those that are capable of conducting an electrical current.

3.3 Direct Current (DC) - Flow of electrical current in one direction at a constant rate.

3.4 Electrical Conductivity - A measure of the ease with which a material is capable of conducting an electrical current. Conductivity = 1/Resistance.

3.5 Electrical Resistance - Property of an object to resist or oppose the flow of an electrical current.

3.6 Non-Conductive (Insulating) Hose - Non-conductive hose constructions are those that resist the flow of electrical current.

3.7 Ohm's Law - The electrical current, "I," is equal to the applied voltage, "V," divided by the resistance, "R." In practical terms, the higher the electrical resistance at a constant voltage, the lower the electrical current flow through an object.

3.8 Ohm - The amount of resistance that limits the passage of current to one ampere when a voltage of one volt is applied to it.

4.0 Apparatus

4.1 Test Instruments - All test instruments should have a gauge reliability and reproducibility (R&R) of less than 30%. Some instruments made to measure high electrical resistance may have an internal protection circuit built-in, which will cause test errors in the less than one megohm range.

During the test, no more than 3 watts (W) should be dissipated in the specimen to prevent erroneous results due to effects of temperature. The power dissipated should be determined by the square of the open-circuit voltage divided by the measured resistance (see formula below).

$$\text{Power Dissipation} = \frac{(\text{Voltage})^2}{\text{Resistance in Ohms}}$$

To determine the electrical resistance of non-conductive hose, the test should be made with an instrument designed specifically for measuring insulation resistance, having a nominal open-circuit voltage of 500 volts DC, or with any other instrument known to give comparable results. For measuring electrical discontinuity, a 1,000 volt DC source may be used instead of a 500 volt DC source.

For hose with a conductive tube or cover, the resistance values obtained may vary with the applied voltage, and errors may occur at low-test voltages. As a starting point, an ohmmeter (9V) can be used. For tests requiring measurement of electrical continuity between end fittings or through continuous internal or external bonded wires, the instrument used should be an ohmmeter (9V).

Electrical Resistance Tests

For Hose and Hose Assemblies

4.2 Electrodes and Contacts – When the test procedure calls for contact with the hose cover, electrodes should be formed around the outer circumference of the hose as bands 25 mm +2 mm, 0 mm (1"±1/16", 0") wide by applying silver lacquer/conductive liquid and metallic copper foil tape (i.e., 3M Scotch brand) as shown in Figure 6-1. When a conductive silver lacquer (i.e., Colloidal Silver Liquid is available from Ted Pella, Inc. catalog #16031) is used, the surface resistance between any two points on a sample of the dried film should not exceed 100 Ω . When a conductive liquid is used, the electrode contact area should be completely wetted and should remain so until the end of the test.

The conductive liquid should consist of:

- › Anhydrous polyethylene glycol of relative molecular mass 600: 800 parts by mass
- › Water: 200 parts by mass
- › Wetting agent: 1 part by mass
- › Potassium chloride: 10 parts by mass

When the test procedure calls for contact with the hose tube, it is preferable to use a copper plug of external diameter equal to or slightly greater than the hose ID or a steel hose stem, coated with the conducting liquid, and pushed 25 mm (1") into the hose. An alternative for 50 mm (2") and above hose would be to apply the conductive silver lacquer onto the hose ID, then insert the plug or hose stem. The electrical leads from the test instrument should be clean and they should make adequate contact with the metallic copper foil and/or copper plugs/hose stems.

5.0 Preparation and Cleaning for Test

The surfaces of the hose should be clean. If necessary, the hose surface may be cleaned by rubbing with Fuller's earth (magnesium aluminum silicate) and water, followed by a distilled water rinse, then allowing the hose to dry in a non-contaminating environment. Do not use organic materials that attack or swell the rubber, and do not buff or abrade the test surfaces.

The surface of the hose should not be deformed either during the application of the contacts or during the test. When using test pieces, the supports should be outside the test length. When using a long length of hose, the hose should be uncoiled and laid out straight on polyethylene or other suitable insulating material. Care should be taken to ensure that the hose is insulated from any electrical leakage path along the length of the hose.

6.0 Test Conditions

For lab testing, the hose or hose assemblies should be conditioned for at least 16 hours at +23° C ± 2°C (73.4°F ± 3.6°F) with a relative humidity not to exceed 70%. However, it is permissible, by agreement between the supplier and the customer, to use the conditions prevailing in the factory, warehouse or laboratory, provided that the relative humidity does not exceed 70%.

7.0 Test Pieces

Prepare three test pieces approximately 300 mm (12") long from samples taken at random from a production run or lot. Condition the test pieces per section 6.0.

Place the test piece on blocks of polyethylene, or other insulating material, to provide a resistance of greater than 100 Ω between the test piece and the surface on which the blocks are supported. Ensure that the leads from the instrument do not touch each other, the hose or any part except the terminal to which each is connected.

Avoid breathing on the test surfaces, thus creating condensation that may lead to inaccuracies.

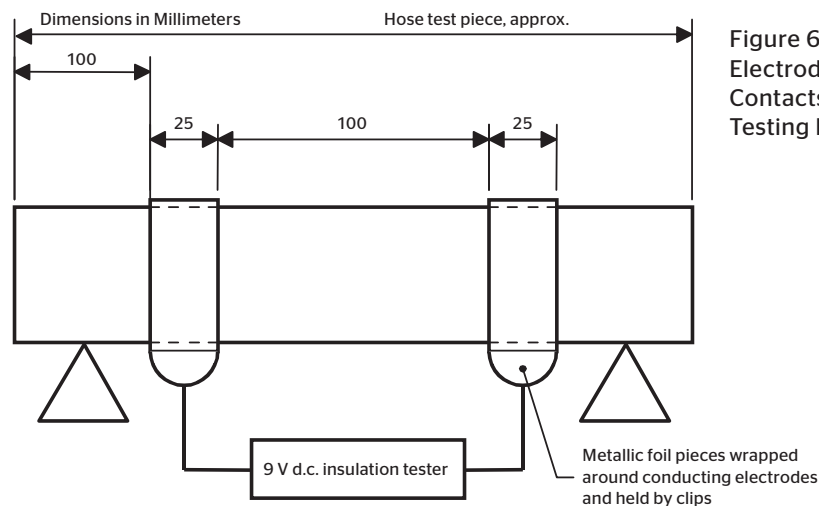

8.0 Procedure for hose with conducting tube

Apply the electrodes as specified to the inside surface of the hose at each end of the hose. The edge of the electrode plug should be coincident with the end of the hose. When using a conductive liquid, care should be taken to avoid creating a leakage path between the tube and the reinforcement or cover of the hose.

Apply the metal contacts to the electrodes.

Apply the test voltage (9V) and measure the resistance 5 seconds \pm 1 second after the voltage is applied.

Note: In previous editions of the Hose Handbook, this method was referred to as the Plug Method.

9.0 Procedure for hose with conducting cover

Apply the electrodes as specified to the outer circumference of the hose at each hose end (see Figure 6-1).

Ensure that contact is maintained with the electrodes around the circumference and that the contact pieces are sufficiently long enough for the two free ends to be held securely by a tensioning clip (see Figure 6-1) such that the fit of the electrodes is as tight as possible.

Apply the metal contacts.

Apply the test voltage (9V) and measure the resistance 5 seconds \pm 1 second after the voltage is applied.

10.0 Procedure for hose with conducting or nonconducting compounds throughout

Apply the electrodes as specified on the inside surface at one end of the hose (end "A") and on the outside surface at the other end of the hose (end "B").

Apply the metal contacts to the electrodes.

Apply the test voltage (9V for conductive compounds and 500V for non-conductive compounds) and measure the resistance for 5 seconds + 1 second after the voltage is applied.

Electrical Resistance Tests

For Hose and Hose Assemblies

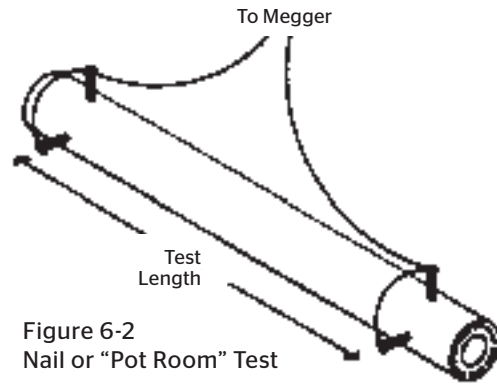

Figure 6-2
Nail or "Pot Room" Test

Alternative Method for Non-Conductive Hose - Nail or "Pot Room" Method

Conduct this test as follows:

1. Cut sample hose, 24 inches long
2. Assure that both inside and outside of the hose are free of oil, dirt, etc.
3. Pierce sample ends with clean nails, as shown in Fig. 6-2
4. Connect nails to 1000V DC power source and megohm meter or 1000V "megger" as shown in Fig. 6-2
5. Record total resistance, in megohms
6. Measure "test length" as shown in Fig. 6-2
7. Divide total resistance by test length to get megohms per inch

11.0 Procedure for hose assemblies fitted with metal end fittings

When it is required that the resistance of a hose assembly be measured, the leads of the test instrument should be attached directly to the metal hose shank (threaded end connection, fixed flange, stub end of a floating flange, etc.) of the metal end fittings.

Some hose, especially thermoplastic hose, have conductive layers within the hose construction. These hose should be tested as assemblies made with fittings and assembly techniques specified by the hose and fitting manufacturer. Apply the metal contacts to the metal end fittings.

Apply the test voltage (9V) and measure the resistance 5 seconds + 1 second after the voltage is applied.

12.0 Procedure for measurement of electrical continuity

In certain types of hose constructions, electrical continuity is provided between the end fittings by means of a continuous wire or wires bonded to each coupling. When the construction is such that there are internal and external wires, the electrical continuity of both wires should be established.

It is essential that contact resistance between the end fittings and the ohmmeter be minimized.

Apply the metal contacts to the metal end fittings.

Apply the test voltage (9V) and measure the resistance for 5 seconds + 1 second after the voltage is applied.

Elastomer Chart

Elastomers Used in the Manufacture of “Rubber Type” Products

Continental Tradename	Industry Designation	Outstanding Feature	Sample Hose
Alphasyn	Modified Cross-Link Polyethylene (Mod XLPE)	Excellent high-temperature chemical resistance.	Tube compound in Viper chemical transfer hose.
Carbryn	Carboxylated Nitrile	Excellent oil and abrasion resistance, good chemical resistance.	Cover compound on multipurpose hose: Gorilla and Ortac. On pressure washer hose: Galvanator and Gauntlet.
Nitrile	Nitrile or Buna-N	Oil, solvent and aromatics resistance.	Tube and cover compound in premium air and multipurpose hose, petroleum transfer hose: Gorilla, Ortac, Flexwing Petroleum.
Chemivic	Nitrile (NBR)	Oil- and abrasion-resistant compound. Excellent ozone resistance.	Cover compound air/mp hose. Tube compound in food hose: White Flexwing.
Chemrin	Chlorinated Polyethylene (CPE)	Excellent chemical resistance.	Tube compound in chemical hose: Brown Flexwing.
Chlorobutyl	Chlorobutyl	FDA compliant material in food hose. Excellent heat resistance.	Tube compound in food hose and Flexsteel 250 CB Steam Hose.
Flosyn	Viton	Excellent oil and chemical resistance.	Tube compound in Orange Flexwing chemical hose.
Chlorosulfonated Polyethylene	Chlorosulfonated Polyethylene (CSM)	Chemical-and oil-resistant.	Tube compound in chemical transfer hose: Yellow Flexwing.
Nylon	Nylon	Resistant to many paint sprays, lacquers, thinners, and mild chemicals.	Tube compound in NR Paint Spray.
Omeegasyn	EPDM (abrasion-resistant)	Excellent abrasion resistance. Mild chemical resistance.	Cover compound: Viper.
SBR	SBR	Good abrasion resistance.	Tube and cover compound in water suction and discharge hose: Plicord Water S&D.
Pyrosyn	EPDM	Heat-resistant.	Tube compound in Flexsteel 250 Steam and Whitewater, Cover on Flexsteel 250 Steam and Flexsteel 250 CB Steam.

Elastomer Chart

Elastomers Used in the Manufacture of “Rubber Type” Products

Continental Tradename	Industry Designation	Outstanding Feature	Sample Hose
Pliosyn	Ultra-High Molecular Weight Polyethylene	Excellent chemical resistance. Good flexibility properties.	Tube compound in Fabchem chemical hose.
Pliovic	Polyvinyl Chloride	Lightweight, flexible and economical.	Pliovic 250, Spiraflex 1600.
Pureten	Natural Rubber	Excellent abrasion resistance, resilient, tensile strength and, retains flexibility below 0°F (-18°C) (poor ozone).	Tube compound in material handling hose: Blucor, Harvest and Tan Flexwing.
Speclar	Cross-Link Polyethylene	Excellent chemical resistance.	Tube compound in Blue Flexwing chemical hose.
Spirathane	Urethane	Excellent abrasion resistance and good chemical resistance.	Spirathane LD and inner liner of Spirathane HD.
Teflon	Fluorinated Propylene or Teflon	Excellent chemical and petroleum resistance.	Tube compound in Hi-Per Teflon Hose.
TPE	Thermoplastic Elastomer	Heat- and/or cold-resistant, flexible and resistant to solvents.	Premier.
Chemituf Polybutadiene	Polybutadiene Blend	Good tensile strength, high elongation, abrasion resistance, nonstatic properties.	Tube compound in Plicord Blast, Plicord Dredge Sleeve, Sand Suction.
EPDM	EPDM	Heat- and/or cold-resistant, weather- and ozone-resistant, mild chemical resistance.	Tube and cover compound in multipurpose hose: Frontier. Cover compound on chemical hose: Fabchem.
Weatherex	Butyl	Low permeability to air and gas; outstanding dampening and shock absorption.	Tube compound in chemical transfer hose: Yellow Flexwing.
Wingprene	Polychloroprene (CR)	All purpose elastomer; good oil, heat and chemical resistance; very good ozone resistance.	Cover compound in petroleum transfer hose: Super Black Flexwing and Red Flextra.

Temperature Conversion Chart

Locate temperature in middle column. If in °C, read °F equivalent in right-hand column; if in °F, read °C in left-hand column.

Temperature Equivalents

$C = 0.556 (°F - 32)$ $F = (1.8 °C) + 32$

-459° to 0°			1° to 60°			61° to 290°			300° to 890°			900° to 3000°		
C	C/F	F	C	C/F	F	C	C/F	F	C	C/F	F	C	C/F	F
-273	-459.4		-17.2	1	33.8	16.1	61	141.8	149	300	572	482	900	1652
-268	-450		-16.7	2	35.6	16.7	62	143.6	154	310	590	488	910	1670
-262	-440		-16.1	3	37.4	17.2	63	145.4	160	320	608	493	920	1688
-257	-430		-15.6	4	39.2	17.8	64	147.2	166	330	626	499	930	1706
-251	-420		-15.0	5	41.0	18.3	65	149.0	171	340	644	504	940	1724
-246	-410		-14.4	6	42.8	18.9	66	150.8	177	350	662	510	950	1742
-240	-400		-13.9	7	44.6	19.4	67	152.6	182	360	680	516	960	1760
-234	-390		-13.3	8	46.4	20.0	68	154.4	188	370	698	521	970	1778
-229	-380		-12.8	9	48.2	20.6	69	156.2	193	380	716	527	980	1796
-223	-370		-12.2	10	50.0	21.1	70	158.0	199	390	734	532	990	1814
-218	-360		-11.7	11	51.8	21.7	71	159.8	204	400	752	538	1000	1832
-212	-350		-11.1	12	53.6	22.2	72	161.6	210	410	770	549	1020	1868
-207	-340		-10.6	13	55.4	22.8	73	163.4	216	420	788	560	1040	1904
-201	-330		-10.0	14	57.2	23.3	74	165.2	221	430	806	571	1060	1940
-196	-320		-9.4	15	59.0	23.9	75	167.0	227	440	824	582	1080	1976
-190	-310		-8.9	16	60.8	24.4	76	168.8	232	450	842	593	1100	2012
-184	-300		-8.3	17	62.6	25.0	77	170.6	238	460	860	604	1120	2048
-179	-290		-7.8	18	64.4	25.6	78	172.4	243	470	878	616	1140	2084
-173	-280		-7.2	19	66.2	26.1	79	174.2	249	480	896	627	1160	2120
-169	-273	-459.4	-6.7	20	68.0	26.7	80	176.0	254	490	914	638	1180	2156
-168	-270	-454	-6.1	21	69.8	27.2	81	177.8	260	500	932	649	1200	2192
-162	-260	-436	-5.6	22	71.6	27.8	82	179.6	266	510	950	660	1220	2228
-157	-250	-418	-5.0	23	73.4	28.3	83	181.4	271	520	968	671	1240	2264
-151	-240	-400	-4.4	24	75.2	28.9	84	183.2	277	530	986	682	1260	2300
-146	-230	-382	-3.9	25	77.0	29.4	85	185.0	282	540	1004	693	1280	2336
-140	-220	-364	-3.3	26	78.8	30.0	86	186.8	288	550	1022	704	1300	2372
-134	-210	-346	-2.8	27	80.6	30.6	87	188.6	293	560	1040	732	1350	2462
-129	-200	-328	-2.2	28	82.4	31.1	88	190.4	299	570	1058	760	1400	2552
-123	-190	-310	-1.7	29	84.2	31.7	89	192.2	304	580	1076	788	1450	2642
-118	-180	-292	-1.1	30	86.0	32.2	90	194.0	310	590	1094	816	1500	2732
-112	-170	-274	-0.6	31	87.8	32.8	91	195.8	316	600	1112	843	1550	2822
-107	-160	-256	0.0	32	89.6	33.3	92	197.6	321	610	1130	871	1600	2912
-101	-150	-238	0.6	33	91.4	33.9	93	199.4	327	620	1148	899	1650	3002
-96	-140	-220	1.1	34	93.2	34.4	94	201.2	332	630	1166	927	1700	3092
-90	-130	-202	1.7	35	95.0	35.0	95	203.0	338	640	1184	954	1750	3182
-84	-120	-184	2.2	36	96.8	35.6	96	204.8	343	650	1202	983	1800	3272
-79	-110	-166	2.8	37	98.6	36.1	97	206.6	349	660	1220	1010	1850	3362
-73	-100	-148	3.3	38	100.4	36.7	98	208.4	354	670	1238	1038	1900	3452
-68	-90	-130	3.9	39	102.2	37.2	99	210.2	360	680	1256	1066	1950	3542
-62	-80	-112	4.4	40	104.0	37.8	100	212.0	366	690	1274	1093	2000	3632
-57	-70	-94	5.0	41	105.8	43	110	230	371	700	1292	1121	2050	3722
-51	-60	-76	5.6	42	107.6	49	120	248	377	710	1310	1149	2100	3812
-46	-50	-58	6.1	43	109.4	54	130	266	382	720	1328	1177	2150	3902
-40	-40	-40	6.7	44	111.2	60	140	284	388	730	1346	1204	2200	3992
-34	-30	-22	7.2	45	113.0	66	150	302	393	740	1364	1232	2250	4082
-29	-20	-4	7.8	46	114.8	71	160	320	399	750	1382	1260	2300	4172
-23	-10	14	8.3	47	116.6	77	170	338	404	760	1400	1288	2350	4262
-17.8	0	32	8.9	48	118.4	82	180	356	410	770	1418	1316	2400	4352
			9.4	49	120.2	88	190	374	416	780	1436	1343	2450	4442
			10.0	50	122.0	93	200	392	421	790	1454	1371	2500	4532
			10.6	51	123.8	99	210	410	427	800	1472	1399	2550	4622
			11.1	52	125.6	100	212	413.6	432	810	1490	1427	2600	4712
			11.7	53	127.4	104	220	428	438	820	1508	1454	2650	4802
			12.2	54	129.2	110	230	446	443	830	1526	1482	2700	4892
			12.8	55	131.0	116	240	464	449	840	1544	1510	2750	4982
			13.3	56	132.8	121	250	482	454	850	1562	1538	2800	5072
			13.9	57	134.6	127	260	500	460	860	1580	1566	2850	5162
			14.4	58	136.4	132	270	518	466	870	1598	1593	2900	5252
			15.0	59	138.2	138	280	536	471	880	1616	1621	2950	5342
			15.6	60	140.0	143	290	554	477	890	1634	1649	3000	5432

Pressure Conversions

Metric to psi (1 kPa = .145 psi)

Kilo Pascals (kPa)	Mega Pascals (MPa)	Bar (Bar)	Pounds per Square Inch (psi)
100	0.1	1	14.5
200	0.2	2	29.0
300	0.3	3	43.5
400	0.4	4	58.0
500	0.5	5	72.5
600	0.6	6	87.0
700	0.7	7	101.5
800	0.8	8	116.0
900	0.9	9	130.5
1,000	1.0	10	145.0
2,000	2.0	20	290.1
3,000	3.0	30	435.1
4,000	4.0	40	580.2
5,000	5.0	50	725.2
6,000	6.0	60	870.2
7,000	7.0	70	1,015
8,000	8.0	80	1,160
9,000	9.0	90	1,305
10,000	10.0	100	1,450
20,000	20.0	200	2,901
30,000	30.0	300	4,351
40,000	40.0	400	5,802
50,000	50.0	500	7,252
60,000	60.0	600	8,702
70,000	70.0	700	10,153
80,000	80.0	800	11,603
90,000	90.0	900	13,053
100,000	100.0	1,000	14,504
200,000	200.0	2,000	29,008
300,000	300.0	3,000	43,511

psi to Metric (1 psi = 6.89 kPa)

Pounds per Square Inch (psi)	Kilo Pascals (kPa)	Mega Pascals (MPa)	Bar (Bar)
10	68.9	0.07	0.7
20	137.9	0.14	1.4
30	206.8	0.21	2.1
40	275.8	0.28	2.8
50	344.7	0.34	3.4
60	413.7	0.41	4.1
70	482.6	0.48	4.8
80	551.6	0.55	5.5
90	620.5	0.62	6.2
100	689	0.7	6.9
200	1,379	1.4	13.8
300	2,068	2.1	20.7
400	2,758	2.8	27.6
500	3,447	3.4	34.5
600	4,137	4.1	41.4
700	4,826	4.8	48.3
800	5,516	5.5	55.2
900	6,205	6.2	62.1
1,000	6,895	6.9	68.9
2,000	13,790	13.8	147.9
3,000	20,684	20.7	206.8
4,000	27,579	27.6	275.8
5,000	34,474	34.5	344.7
6,000	41,369	41.4	413.7
7,000	48,263	48.3	482.6
8,000	55,158	55.2	551.6
9,000	62,053	62.1	620.5
10,000	68,948	68.9	689
20,000	137,895	147.9	1,379
30,000	206,843	206.8	2,068
40,000	275,790	275.8	2,758

Fraction Equivalents

Fractions	Inches Decimals	Millimeters
1/64	0.015625	0.397
1/32	0.03125	0.794
3/64	0.046875	1.191
1/16	0.0625	1.588
5/64	0.078125	1.984
3/32	0.09375	2.381
7/64	0.109375	2.778
1/8	0.125	3.175
9/64	0.140625	3.572
5/32	0.15625	3.969
11/64	0.171875	4.366
3/16	0.1875	4.763
13/64	0.203125	5.159
7/32	0.21875	5.556
15/64	0.234375	5.953
1/4	0.250	6.350
17/64	0.265625	6.747
9/32	0.28125	7.144
19/64	0.296875	7.541
5/16	0.3125	7.938
21/64	0.328125	8.334
11/32	0.34375	8.731
23/64	0.359375	9.128
3/8	0.375	9.525
25/64	0.390625	9.922
13/32	0.40625	10.319
27/64	0.421875	10.716
7/16	0.4375	11.113
29/64	0.453125	11.509
15/32	0.46875	11.906
31/64	0.484375	12.303
1/2	0.500	12.700

Fractions	Inches Decimals	Millimeters
33/64	0.515625	13.097
17/32	0.53125	13.494
35/64	0.546875	13.891
9/16	0.5625	14.288
37/64	0.578125	14.684
19/32	0.59375	15.081
39/64	0.609375	15.478
5/8	0.625	15.875
41/64	0.640625	16.272
21/32	0.65625	16.669
43/64	0.671875	17.066
11/16	0.6875	17.463
45/64	0.703125	17.859
23/32	0.71875	18.256
47/64	0.734375	18.653
3/4	0.750	19.150
49/64	0.765625	19.447
25/32	0.78125	19.844
51/64	0.796875	20.241
13/16	0.8125	20.638
53/64	0.828125	21.034
27/32	0.84375	21.431
55/64	0.859375	21.828
7/8	0.875	22.225
57/64	0.890625	22.622
29/32	0.90625	23.019
59/64	0.921875	23.416
15/16	0.9375	23.813
61/64	0.953125	24.209
31/32	0.96875	24.606
63/64	0.984375	25.003
1	1.000	25.400

Conversion Constants

Length Conversion Constants

Metric to U.S.

Millimeters x .039370 = Inches

Meters x 39.370 = Inches

Meters x 3.2808 = Feet

Meters x 1.09361 = Yards

Kilometers x 3,280.8 = Feet

Kilometers x .62137 = Statute Miles

Kilometers x .53959 = Nautical Miles

U.S. to Metric

Inches x 25.4001 = Millimeters

Inches x .0254 = Meters

Feet x .30480 = Meters

Yards x .91440 = Meters

Feet x .0003048 = Kilometers

Statute Miles x 1.60935 = Kilometers

Nautical Miles x 1.85325 = Kilometers

Weight Conversion Constants

Metric to U.S.

Grams x 981 = Dynes

Grams x 15.432 = Grains

Grams x .03528 = Ounces (Avd.)

Grams x .033818 = Fluid Ounces (Water)

Kilograms x 35.27 = Ounces (Avd.)

Kilograms x 2.20462 = Pounds (Avd.)

Metric Tons (1000 Kg) x 1.10231 = Net Ton (2000 lbs.)

Metric Tons (1000 Kg) x .98421 = Gross Ton (2240 lbs.)

U.S. to Metric

Dynes x .0010193 = Grams

Grains x .0648 = Grams

Ounces (Avd.) x 28.35 = Grams

Fluid Ounces (Water) x 29.57 = Grams

Ounces (Avd.) x .02835 = Kilograms

Pounds (Avd.) x .45359 = Kilograms

Net Ton (2000 lbs.) x .90719 = Metric Tons (1000kg)

Gross Ton (2240 lbs.) x 1.101605 = Metric Tons (1000kg)

Area Conversion Constants

Metric to U.S.

Square Millimeters x .00155 = Square Inches

Square Centimeters x .155 = Square Inches

Square Meters x 10.76387 = Square Feet

Square Meters x 1.19599 = Square Yards

Hectares x 2.47104 = Acres

Square Kilometers x 247.104 = Acres

Square Kilometers x .3861 = Square Miles

U.S. to Metric

Square Inches x 645.163 = Square Millimeters

Square Inches x 6.45163 = Square Centimeters

Square Feet x .0929 = Square Meters

Square Yards x .83613 = Square Meters

Acres x .40469 = Hectares

Acres x .0040469 = Square Kilometers

Square Miles x 2.5899 = Square Kilometers

Pressure Conversion Constants

Metric to U.S.

Bar x 14.5 = psi

Mega Pascals x 145.0 = psi

kgf/cm² x 14.22 = psi

U.S. to Metric

psi x .0689 = Bar

psi x .0069 = Mega Pascals (MPa)

psi x .0703 = kgf/cm²

Production Run Minimum Requirements

Order Code Prefix	Manufacturing Facility	Description	Construction	Minimum Production Run
532	Norfolk	5/8" - 2"	Textile Reinforcement	2,500 feet
		5/8" - 2"	Wire Reinforcement	5,000 feet
535	Norfolk	3/16" - 1/4"	Textile Reinforcement	5,000 feet
		3/8" - 1"		2,500 feet
		1 1/4" - 2"		2,000 feet
535	Norfolk	3/16" - 1"	Wire Reinforcement	2,500 feet
	Military			2,500 feet
	Private Brand			2,500 feet
	GNSPEC			2,500 feet
536	Norfolk	3/16" - 1/4"	Textile Reinforcement	5,000 feet
		3/8" - 1 1/4"		2,500 feet
		1 1/2" - 2"		2,500 feet
547	Norfolk	3/16" - 1"	Wire Reinforcement	2,500 feet
		Military		2,500 feet
		Private Brand		2,500 feet
		GNSPEC		2,500 feet
		Special Lengths/ Packaging Requirements		2,500 feet

INDEX



Alphanumeric Index by Descriptive Number

DESCRIPTIVE #	PAGE #	DESCRIPTIVE #	PAGE #
AC-COTF134V90B.....	311	AC-SFM45.....	330
AC-COTF45.....	310	AC-SFM90.....	330
AC-COTF90.....	310	AC-SWA.....	358
AC-COTF90B.....	310	AC-SWCN.....	358
AC-FTM.....	311	AC-SWCW.....	358
AC-FTM90B.....	312	AC-VA12V1/4.....	358
AC-FTMM.....	312	AC-VA12V3/16.....	358
AC-FTN.....	356	AC-VC12V.....	359
AC-FTS.....	356	AC-VC134VHS.....	359
AC-FTSM.....	356	AC-VC134VLS.....	359
AC-HM.....	313	AC-VCORE.....	359
AC-HM12V.....	314	ACP3.....	12, 35, 112-113, 119, 121
AC-HM134V.....	314	ACP4.....	12, 37
AC-HM90.....	313	Aluminum.....	476-505
AC-HMSG.....	314	ARC12.....	12, 44, 114-115, 119, 121
AC-HMT.....	315	ARC13.....	12, 45, 114-115, 119, 121
AC-ILOTBLK.....	357	ARC15.....	12, 46, 114-115, 119, 121
AC-ILOTBLU.....	357	ARC16SC.....	12, 43, 112-113, 119, 121
AC-ILOTORA.....	357	B2-BFFX.....	169
AC-ILOTRED.....	357	B2-BPFX.....	166
AC-ILOTWHI.....	357	B2-BPFX45.....	167
AC-OIM.....	315	B2-BPFX90.....	167
AC-OIM134V.....	317	B2-BPM.....	168
AC-OIM134V90.....	318	B2-BTM.....	168
AC-OIM45.....	316	B2-CF.....	163
AC-OIM90.....	316	B2-CF22.....	163
AC-OIMB.....	317	B2-CF45.....	163
AC-OIMB90.....	317	B2-CF60.....	164
AC-OTCF10.....	354	B2-CF67.....	164
AC-OTF.....	318	B2-CF90.....	164
AC-OTF06.....	354-355	B2-DHFX.....	172
AC-OTF08.....	354-355	B2-DHFX45.....	173
AC-OTF10.....	354-355	B2-DHFX90.....	174
AC-OTF12.....	354-355	B2-DHFX90L.....	174
AC-OTF12V.....	322	B2-DHFX90XL.....	174
AC-OTF12V90.....	323	B2-DHM.....	175
AC-OTF134V.....	323	B2-DLFX.....	169
AC-OTF134V45.....	324	B2-DLFX45.....	170
AC-OTF134V90.....	324	B2-DLFX90.....	170-171
AC-OTF134VHS.....	323	B2-DLFX90XL.....	171
AC-OTF180.....	320	B2-DLM.....	171
AC-OTF45.....	319	B2-DNFX45.....	175
AC-OTF90.....	319	B2-DNFX90.....	176
AC-OTF90B.....	320	B2-FH.....	160
AC-OTFM.....	321	B2-FH22.....	160
AC-OTFM45.....	321	B2-FH30.....	161
AC-OTFM90.....	322	B2-FH45.....	161
AC-OTM.....	325	B2-FH60.....	162
AC-OTM134V.....	327	B2-FH90.....	162
AC-OTM134V90.....	327	B2-FL.....	156
AC-OTM45.....	325	B2-FL22.....	156
AC-OTM90.....	326	B2-FL30.....	157
AC-OTMLP.....	326	B2-FL45.....	157
AC-OTUBE.....	358	B2-FL60.....	158
AC-SFFX.....	328	B2-FL67.....	158
AC-SFFX45.....	328	B2-FL90.....	159
AC-SFFX90.....	329	B2-FL110.....	159
AC-SFM.....	329	B2-FTM.....	148

Alphanumeric Index by Descriptive Number

DESCRIPTIVE #	PAGE #	DESCRIPTIVE #	PAGE #
B2-GTF.....	148	BT-NPM.....	240
B2-HJ.....	178	BT-OFFX.....	240
B2-IHUF1502.....	165, 374	Carbon Steel.....	476-505
B2-IHUM1502.....	165, 374	CB101.....	422
B2-JCFX.....	135-136	CPE.....	476-505, 517
B2-JCFX45.....	136	CR.....	476-505, 518
B2-JCFX90.....	137-138	CSM.....	476-505, 517
B2-JCFX90B.....	139	Desert DUT.....	13, 52, 116-118, 121
B2-JCFX90L.....	137-138	DG-BPFX.....	233
B2-JCFX90S.....	137-138	DG-BPFX45.....	234
B2-JCM.....	139-140	DG-BPFX90.....	234
B2-JSFX.....	178	DG-FH.....	227
B2-KF.....	165	DG-FH45.....	229
B2-KF45.....	165	DG-FH90.....	230
B2-KF90.....	166	DG-FL.....	224
B2-KMFX.....	176	DG-FL30.....	225
B2-KMFX45.....	177	DG-FL45.....	225
B2-KMFX90.....	177	DG-FL90.....	227
B2-NPF.....	144	DG-JCFX.....	219
B2-NPFX.....	144	DG-JCFX90.....	220
B2-NPM.....	145, 375	DG-JCM.....	220
B2-NPMAPI.....	374	DG-NPM.....	221
B2-NPMX.....	146	DG-NPMAPI.....	221
B2-NPMX90B.....	147	DG-OFFX.....	222
B2-NSFX.....	147	DG-OFFX90.....	223
B2-OBM.....	154	DGF1.....	387
B2-OBMX.....	155	DGF2.....	387
B2-OBMX90B.....	155	DR16SC.....	13, 50, 112-113, 118, 121
B2-OFFX.....	150	DR1SN.....	13, 48, 112-113, 118, 121
B2-OFFX45.....	151	DR2SN.....	13, 49, 112-113, 118, 121
B2-OFFX90.....	152-153	DR5.....	13, 51, 116-118, 121
B2-OFFX90L.....	152-153	DUT.....	13, 52, 116-118, 121
B2-OFFX90S.....	152-153	FG-JCFX.....	281
B2-OFM.....	153	FG-JCFX45.....	281
B2-SFFX.....	140	FG-JCFX90.....	282
B2-SFFX45.....	141	FG-JCFX90L.....	282
B2-SFFX90.....	141	FG-JCM.....	282
B2-SFFX90L.....	141	FG-NPM.....	284
B2-SFFX90S.....	141	FG-OBM.....	285
B2-SFM.....	142	FG-SFFX.....	283
B2-SIMX.....	142	FG-SFM.....	283
B2-SIMX45.....	143	FG-SIMX.....	284
B2-SIMX90.....	143	FL61SC.....	394
B2-SP.....	149	FL62SC.....	394
B2-SP45.....	149	FXG.....	15, 89, 112-113, 120-121
BOP.....	14, 76-77, 116-117, 120-121	G4826.....	15, 91, 116-117
BOP3000.....	14, 76, 116-117, 120-121	G4867.....	15, 92, 116-117
BOP5000.....	14, 77, 116-117, 120-121	G4890.....	15, 93, 116-117
BR7.....	15, 101, 114-115, 118, 121	GC-CB12VS90.....	331
Brass.....	476-505	GC-CB12VSR90.....	331
BT-FL.....	241	GC-CLIP.....	360
BT-FL90.....	241	GC-CLIPHLDR.....	360
BT-JCFX.....	238	GC-COTF134V90B.....	333
BT-JCFX45.....	238	GC-COTF45.....	332
BT-JCFX90.....	239	GC-COTF90.....	332
BT-JCFX90L.....	239	GC-COTF90B.....	332
BT-JCFX90S.....	239	GC-FSLF.....	335
BT-JCM.....	239	GC-FSLF45.....	336

Alphanumeric Index by Descriptive Number

DESCRIPTIVE #	PAGE #	DESCRIPTIVE #	PAGE #
GC-FSLF90.....	336	HRC.....	123
GC-FSLM.....	337	HS150.....	419
GC-FSLM45.....	337	HS150M.....	419
GC-FSLM90.....	338	HS501.....	420
GC-FTBO.....	333	HS503.....	420
GC-FTM.....	334	HWRAP.....	122
GC-FTM90B.....	334	IG.....	15, 86, 112-113, 120-121
GC-FTMM.....	335	IGHT.....	15, 87, 112-113, 120-121
GC-HM.....	338	IGTC.....	15, 88, 112-113, 120-121
GC-HM12V.....	339	LR16SC.....	13, 56, 112-113, 118
GC-HM134V.....	340	LR2AT.....	55
GC-HM180.....	339	LR2SN.....	13, 55, 112-113, 118, 121
GC-HM90.....	339	M13531.....	14, 82, 116-117, 120-121
GC-HMSG.....	340	M3992.....	14, 83, 116-117, 120-121
GC-HMT.....	340	M8788.....	15, 84, 116-117, 120-121
GC-OFFX.....	341	MIL-H-13444-I.....	14, 80, 116-117, 120-121
GC-OFFX90.....	341	MIL-H-13444-III.....	14, 81, 116-117, 120-121
GC-OFSL.....	357	NBR.....	476-505, 517
GC-OIM.....	341	Nitrile.....	476-505, 517
GC-OIM134V.....	343	NR7.....	15, 97, 114-115, 118, 121
GC-OIM134V90.....	343	NR8.....	15, 98, 114-115, 119, 121
GC-OIM45.....	342	NSFX.....	14, 73, 116-118, 121
GC-OIM90.....	342	Nylon.....	476-505, 517
GC-OIMB.....	342	O6162.....	393
GC-OIMB90.....	343	OBSPP.....	392
GC-OSWCH.....	357	ODIN24H.....	392
GC-OTF.....	344	ODIN24L.....	392
GC-OTF12V.....	346	OORFS.....	393
GC-OTF12V90.....	346	ORB.....	393
GC-OTF134V.....	347	PB-HM.....	376
GC-OTF134V45.....	347	PB-JCFX.....	376
GC-OTF134V90.....	348	PB-JCFX90.....	377
GC-OTF134VHS.....	346	PB-JCM.....	377
GC-OTF180.....	346	PB-NPF.....	378
GC-OTF45.....	344	PB-NPM.....	378
GC-OTF90.....	345	PB-NPM90.....	379
GC-OTF90B.....	345	PB-NPMX.....	379
GC-OTM.....	348	PB-SFFX.....	380
GC-OTM134V.....	350	PB-SFM.....	380
GC-OTM134V90.....	350	PB-SIF.....	381
GC-OTM45.....	349	PB-SIM.....	381
GC-OTM90.....	349	PC125M.....	400-401
GC-OTMLP.....	350	PC125PS.....	404-405
GC-PLIERS.....	361	PC125RCD.....	402-403
GC-SFFX.....	351	PC150.....	408-409
GC-SFFX45.....	357	PC150H.....	406-407
GC-SFFX90.....	352	PC200i.....	410-411
GC-SFM.....	352	PC440i.....	412-413
GC-SFM45.....	353	PC600i.....	414-415
GC-SFM90.....	353	PC1000i.....	416-417
GFIT100.....	396	PCTB-1500.....	418
GG-NPM.....	375	PCTB-2500.....	418
GTEXS.....	122	PTFE.....	476-505
HCT.....	361	PVC.....	476-505
HCTRB.....	361	S4SH.....	14, 68, 114-115, 119, 121
Hot Oiler.....	14, 78, 116-117	S4SP.....	14, 69, 114-115, 119, 121
HR4.....	15, 104, 112-113, 118, 121	S6-BPFX.....	233
HR6.....	13, 53, 112-113, 118, 121	S6-BPFX45.....	234

Alphanumeric Index by Descriptive Number

DESCRIPTIVE #	PAGE #	DESCRIPTIVE #	PAGE #
S6-BPFX90	234	SG-DHM	213
S6-BPM	235	SG-DLFX	209-210
S6-BTM	235	SG-DLFX45	210
S6-CF	230	SG-DLFX90	210-211
S6-CF22	231	SG-DLFX90XL	211
S6-CF30	231	SG-DLM	211
S6-CF45	231	SG-FH	198
S6-CF60	232	SG-FH22	199
S6-CF90	232	SG-FH30	199
S6-FH	227	SG-FH45	200
S6-FH22	228	SG-FH60	200
S6-FH30	228	SG-FH67	201
S6-FH45	229	SG-FH90	201
S6-FH60	229	SG-FL	193
S6-FH90	230	SG-FL110	197
S6-FL	224	SG-FL135	198
S6-FL22	224	SG-FL22	193
S6-FL30	225	SG-FL30	194
S6-FL45	225	SG-FL45	194-195
S6-FL60	226	SG-FL60	195
S6-FL67	226	SG-FL67	196
S6-FL90	227	SG-FL90	196-197
S6-IHUF1502	233	SG-FL90L	196-197
S6-IHUM1502	233	SG-IHUF1502	205
S6-JCFX	219	SG-IHUM1502	205
S6-JCFX45	219	SG-JCFX	183
S6-JCFX90	220	SG-JCFX45	184
S6-JCM	220	SG-JCFX90	184-185
S6-NPM	221	SG-JCFX90B	186
S6-NPMAPI	221	SG-JCFX90L	184-185
S6-OFFX	222	SG-JCFX90S	184-185
S6-OFFX45	222	SG-JCM	186
S6-OFFX90	223	SG-JSFX	215
S6-OFM	223	SG-KF	206
SCP3	13, 61, 112-113, 119, 121	SG-KF45	206
SF-JCFX	372	SG-KF90	206
SF-NPM	372	SG-KMFX	214
SF-NPMX	372	SG-KMFX45	214
SF-OBM	373	SG-KMFX90	215
SF-OBMX	373	SG-NPF	187
SFS	14, 75, 112-113, 118, 121	SG-NPM	187
SG-BFFX	209	SG-NPMAPI	188
SG-BPFX	207	SG-NPMX	188
SG-BPFX45	207	SG-NSFX	188
SG-BPFX90	208	SG-OBM	192
SG-BPM	208	SG-OFFX	189
SG-BTM	209	SG-OFFX45	190
SG-CF	202	SG-OFFX90	190-191
SG-CF22	202	SG-OFFX90L	190-191
SG-CF30	203	SG-OFFX90S	190-191
SG-CF45	203	SG-OFM	192
SG-CF60	204	SG-SP	189
SG-CF67	204	SGUN	14, 71, 116-117, 120-121
SG-CF90	205	SHJ	14, 72, 116-117, 120-121
SG-CF90L	205	SR12	13, 65, 114-115, 119, 121
SG-DHFX	211-212	SR13	14, 66, 114-115, 119, 121
SG-DHFX45	212	SR14A	14, 74, 116-117, 119, 121
SG-DHFX90	213	SR15	14, 67, 114-115, 119, 121

Alphanumeric Index by Descriptive Number

DESCRIPTIVE #	PAGE #	DESCRIPTIVE #	PAGE #
SR16SC.....	13, 60, 112-113, 119, 121	T8-SFFX.....	292
SR18.....	15, 102, 114-115, 120-121	T8-SFFX90.....	292
SR1SN.....	13, 58, 112-113, 118, 121	T8-SIMX45.....	293
SR2SN.....	13, 59, 112-113, 118, 121	T8-SIMX90.....	293
SR3.....	13, 62, 112-113, 118, 121	T8-SP45.....	297
SR5.....	13, 63, 116-118, 121	TR7.....	15, 99, 114-115, 118, 121
SR6.....	13, 64, 112-113, 118, 121	TR8.....	15, 100, 114-115, 118, 121
SR7.....	15, 95, 114-115, 118, 121	UC-BFFX.....	271
SR8.....	15, 96, 114-115, 118, 121	UC-BPFX.....	268
Stainless Steel 304.....	476-505	UC-BPFX45.....	269
Stainless Steel 316.....	476-505	UC-BPFX90.....	269
T7-BPFX.....	301	UC-BPM.....	270
T7-BPFX90.....	302	UC-BTM.....	270
T7-FTM.....	297	UC-DHFX.....	273
T7-JCFX.....	288	UC-DHFX45.....	274
T7-JCFX45.....	289	UC-DHFX90.....	274
T7-JCFX90.....	290	UC-DHM.....	275
T7-JCFX90L.....	290	UC-DLFX.....	271
T7-JCM.....	291	UC-DLFX45.....	272
T7-JSFX.....	302	UC-DLFX90.....	272
T7-NPF.....	294	UC-DLM.....	273
T7-NPM.....	294-295	UC-DNFX45.....	275
T7-NPMX.....	296	UC-DNFX90.....	276
T7-NSFX.....	296	UC-FH.....	267
T7-OBM.....	300	UC-FH45.....	267
T7-OBMX.....	300	UC-FH90.....	268
T7-OBMX90B.....	301	UC-FL.....	263
T7-OFFX.....	298	UC-FL22.....	264
T7-OFFX45.....	298	UC-FL30.....	264
T7-OFFX90.....	299	UC-FL45.....	265
T7-OFFX90L.....	299	UC-FL60.....	265
T7-OFM.....	299	UC-FL90.....	266
T7-SFFX.....	292	UC-FTM.....	257
T7-SFFX90.....	292	UC-HJ.....	278
T7-SIMX.....	293	UC-JCFX.....	245-246
T7-SIMX90.....	293	UC-JCFX45.....	246-247
T7-SP45.....	297	UC-JCFX90.....	247-248
T8-BPFX.....	301	UC-JCFX90L.....	247-248
T8-BPFX90.....	302	UC-JCFX90S.....	247-248
T8-DNFX90.....	302	UC-JCM.....	249
T8-FTM.....	297	UC-JSFX.....	278
T8-JCFX.....	288	UC-KMFX.....	276
T8-JCFX45.....	289	UC-KMFX45.....	277
T8-JCFX90.....	290	UC-KMFX90.....	277
T8-JCFX90L.....	290	UC-NPF.....	253
T8-JCM.....	291	UC-NPM.....	254-255
T8-JSFX.....	302	UC-NPMX.....	255
T8-NPF.....	294	UC-NPMX90B.....	256
T8-NPM.....	294-295	UC-NSFX.....	256
T8-NPMX.....	295	UC-OBM.....	262
T8-NSFX.....	296	UC-OBMX.....	262
T8-OBM.....	300	UC-OBMX90B.....	263
T8-OBMX.....	300	UC-OFFX.....	258-259
T8-OBMX90B.....	301	UC-OFFX45.....	259
T8-OFFX.....	298	UC-OFFX90.....	260-261
T8-OFFX45.....	298	UC-OFFX90L.....	260-261
T8-OFFX90.....	299	UC-OFFX90S.....	260-261
T8-OFFX90L.....	299	UC-OFM.....	261

Alphanumeric Index by Descriptive Number

DESCRIPTIVE #	PAGE #	DESCRIPTIVE #	PAGE #
UC-SFFX.....	250	UT-FL90EOC.....	369
UC-SFFX45.....	250	UT-FTM.....	369
UC-SFFX90.....	251	UT-JCFX.....	364
UC-SFFX90L.....	251	UT-JCFX45.....	364
UC-SFFX90S.....	251	UT-JCFX90.....	365
UC-SFM.....	251	UT-NPM.....	368
UC-SIMX.....	252	UT-PTTFX.....	369
UC-SIMX45.....	252	UT-SFFX.....	365
UC-SIMX90.....	253	UT-SFFX45.....	366
UC-SP.....	257	UT-SFFX90.....	366
UC-SP45.....	258	UT-SIMX.....	367
UCF2.....	383	UT-SIMX45.....	367
UCF3.....	383	UT-SIMX90.....	368
UCF6.....	384	XCP3.....	12, 34, 112-113, 119, 121
UCF8.....	385	XCP3S.....	12, 38, 114-115, 119
UCF9.....	385	XCP4.....	12, 36, 114-115, 119, 121
UCF10.....	386	XCP4S.....	12, 39, 114-115, 119
UCF11.....	386	XCP5S.....	12, 40, 114-115, 119
UCH-JCFX.....	245	XCP6S.....	12, 41, 114-115, 119
Urethane.....	476-505, 518	XR16SC.....	2, 12, 32, 112-113, 119, 121

Alphanumeric Index by Product Number

PRODUCT #	PAGE #	PRODUCT #	PAGE #
14100.....	169	14730.....	153
14105.....	166	14775.....	140
14115.....	167	14777.....	141
14120.....	167	14780.....	141
14130.....	168	14781.....	141
14170.....	168	14783.....	141
14210.....	172	14785.....	142
14215.....	173	14800.....	142
14220.....	174	14810.....	143
14225.....	175	14815.....	143
14240.....	169	14825.....	149
14245.....	170	14830.....	149
14250.....	170-171	14840.....	178
14255.....	171	16105.....	233
14275.....	175	16115.....	234
14280.....	176	16120.....	234
14300.....	160	16300.....	227
14310.....	161	16310.....	229
14315.....	162	16315.....	230
14320.....	156	16320.....	224
14330.....	156	16335.....	225
14335.....	157	16340.....	225
14340.....	157	16350.....	227
14345.....	158	16400.....	219
14347.....	158	16425.....	220
14350.....	159	16450.....	220
14360.....	148	16615.....	221
14370.....	148	16630.....	221
14390.....	165	16700.....	222
14395.....	165	16715.....	223
14400.....	135	18400.....	281
14420.....	136	18420.....	281
14425.....	137-138	18425.....	282
14440.....	137-138	18440.....	282
14445.....	137-138	18450.....	282
14447.....	139	18615.....	284
14450.....	139-140	18670.....	285
14520.....	178	18775.....	283
14530.....	165	18785.....	283
14535.....	165	18800.....	284
14540.....	166	20615.....	375
14545.....	176	22380.....	376
14548.....	177	22400.....	376
14550.....	177	22425.....	377
14600.....	144	22450.....	377
14605.....	144	22600.....	378
14615.....	145, 375	22615.....	378
14645.....	146	22625.....	379
14650.....	147	22645.....	379
14655.....	147	22775.....	380
14670.....	154	22785.....	380
14680.....	155	22790.....	381
14685.....	155	22795.....	381
14700.....	150	26400.....	372
14710.....	151	26615.....	372
14715.....	152-153	26645.....	372
14720.....	152-153	26670.....	372
14725.....	152-153	26680.....	372

Alphanumeric Index by Product Number

PRODUCT #	PAGE #	PRODUCT #	PAGE #
28105.....	166	29192.....	204
28115.....	167	29194.....	204
28120.....	167	29195.....	205
28130.....	168	29197.....	205
28185.....	163	29210.....	211-212
28187.....	163	29215.....	212
28190.....	163	29220.....	213
28192.....	164	29225.....	213
28194.....	164	29240.....	184, 209-210
28195.....	164	29245.....	210
28210.....	172	29250.....	210-211
28220.....	174	29252.....	211
28240.....	169	29255.....	211
28245.....	170	29300.....	198
28250.....	171	29303.....	199
28300.....	160	29305.....	199
28303.....	160	29310.....	200
28305.....	161	29312.....	200
28310.....	161	29313.....	201
28312.....	162	29315.....	201
28315.....	162	29317A.....	201
28320.....	156	29317B.....	201
28330.....	156	29320.....	193
28335.....	157	29330.....	193
28340.....	157	29335.....	194
28345.....	158	29340.....	194-195, 200
28347.....	158	29345.....	195
28350.....	159	29347.....	196
28354.....	159	29350.....	196-197
28390.....	165, 374	29350A.....	196-197
28395.....	165, 374	29352.....	196-197
28400.....	136	29354.....	197
28420.....	136	29355.....	198
28425.....	138	29390.....	205
28450.....	140	29395.....	205
28520.....	178	29400.....	183
28545.....	176	29420.....	184
28615.....	145	29425.....	184-185
28617.....	374	29440.....	184-185
28655.....	147	29445.....	184-185
28670.....	154	29450.....	186
28700.....	150	29520.....	215
28710.....	151	29530.....	206
28715.....	153	29535.....	206
28720.....	153	29540.....	206
28725.....	153	29545.....	214
28730.....	153	29548.....	214
28840.....	178	29550.....	215
29100.....	209	29600.....	187
29105.....	207	29615.....	187
29115.....	207	29617.....	188
29120.....	208	29645.....	188
29130.....	208	29655.....	188
29170.....	209	29670.....	192
29185.....	202	29700.....	189
29187.....	202	29710.....	190
29188.....	203	29715.....	190-191
29190.....	203	29720.....	190-191

Alphanumeric Index by Product Number

PRODUCT #	PAGE #	PRODUCT #	PAGE #
29725.....	190-191	32710.....	298
29730.....	192	32715.....	299
29825.....	189	32720.....	299
30105.....	233	32730.....	299
30110.....	234	32775.....	292
30115.....	234	32780.....	292
30120.....	234	32800.....	293
30130.....	235	32815.....	293
30170.....	235	32830.....	297
30185.....	230	34105.....	301
30187.....	231	34120.....	302
30188.....	231	34280.....	302
30190.....	231	34360.....	297
30192.....	232	34400.....	288
30195.....	232	34420.....	289
30300.....	227	34425.....	290
30303.....	228	34440.....	290
30305.....	228	34450.....	291
30310.....	229	34520.....	302
30312.....	229	34600.....	294
30315.....	230	34615.....	294-295
30320.....	224	34645.....	296
30330.....	224	34655.....	296
30335.....	225	34670.....	300
30340.....	225	34680.....	300
30345.....	226	34685.....	301
30347.....	226	34700.....	298
30350.....	227	34710.....	298
30390.....	233	34715.....	299
30395.....	233	34720.....	299
30400.....	219	34775.....	292
30420.....	219	34780.....	292
30425.....	220	34810.....	293
30450.....	220	34815.....	293
30615.....	221	34830.....	297
30617.....	221	36100.....	271
30618.....	221	36105.....	268
30700.....	222	36115.....	269
30710.....	222	36120.....	269
30715.....	223	36130.....	270
30730.....	223	36170.....	270
32105.....	301	36210.....	273
32120.....	302	36215.....	274
32360.....	297	36220.....	274
32400.....	288	36225.....	275
32420.....	289	36240.....	271
32425.....	290	36245.....	272
32440.....	290	36250.....	272
32450.....	291	36255.....	273
32520.....	302	36275.....	275
32600.....	294	36280.....	276
32615.....	294-295	36300.....	267
32645.....	296	36310.....	267
32655.....	296	36315.....	268
32670.....	300	36320.....	263
32680.....	300	36330.....	264
32685.....	301	36335.....	264
32700.....	298	36340.....	265

Alphanumeric Index by Product Number

PRODUCT #	PAGE #	PRODUCT #	PAGE #
36345.....	265	38780.....	366
36350.....	266	38800.....	367
36360.....	257	38810.....	367
36400.....	245-246	38815.....	368
36420.....	246-247	50133.....	310
36425.....	247-248	50135.....	310
36440.....	247-248	50137.....	310
36445.....	247-248	50145.....	311
36450.....	249	50230.....	311
36520.....	278	50235.....	312
36545.....	276	50240.....	312
36548.....	277	50250.....	356
36550.....	277	50255.....	356
36600.....	253	50260.....	356
36615.....	254-255	50350.....	313
36645.....	255	50355.....	313
36650.....	256	50365.....	314
36655.....	256	50370.....	314
36670.....	262	50375.....	314
36680.....	262	50380.....	315
36685.....	262	50401.....	357
36700.....	258-259	50402.....	357
36710.....	259	50403.....	357
36715.....	260-261	50460.....	358
36720.....	260-261	50500.....	315
36725.....	260-261	50503.....	316
36730.....	261	50505.....	316
36775.....	250	50515.....	317
36777.....	250	50520.....	317
36780.....	251	50530.....	317
36781.....	251	50535.....	318
36783.....	251	50600.....	318
36785.....	251	50603.....	319
36800.....	252	50605.....	319
36810.....	252	50610.....	320
36815.....	253	50615.....	320
36825.....	257	50630.....	321
36830.....	258	50633.....	321
36840.....	278	50635.....	322
37320.....	241	50650.....	322
37350.....	241	50655.....	323
37400.....	238	50660.....	323
37420.....	238	50663.....	324
37425.....	239	50665.....	324
37440.....	239	50675.....	323
37445.....	239	50700.....	325
37450.....	239	50703.....	325
37615.....	240	50705.....	326
37700.....	240	50720.....	326
38351.....	369	50730.....	327
38360.....	369	50735.....	327
38400.....	364	50760.....	328
38420.....	364	50763.....	328
38425.....	365	50765.....	329
38615.....	368	50780.....	329
38745.....	369	50783.....	330
38775.....	365	50785.....	330
38777.....	366	50800.....	358

Alphanumeric Index by Product Number

PRODUCT #	PAGE #	PRODUCT #	PAGE #
50803.....	358	54720.....	350
50805.....	358	54730.....	350
50820.....	358	54735.....	350
50830.....	359	54760.....	351
50835.....	359	54763.....	351
50900.....	354	54765.....	352
50910.....	354	54780.....	352
50915.....	354	54783.....	353
50920.....	355	54785.....	353
50925.....	355	54850.....	360
54110.....	331	54855.....	360
54112.....	331	54860.....	361
54133.....	332	60061.....	394
54135.....	332	60062.....	394
54137.....	332	60200.....	122
54145.....	333	60210.....	122
54210.....	333	60300.....	123
54230.....	334	60500.....	393
54235.....	334	60505.....	392
54240.....	335	60515.....	392
54300.....	335	60520.....	392
54303.....	336	60525.....	393
54305.....	336	60530.....	393
54330.....	337	65090.....	361
54333.....	337	65091.....	361
54335.....	338	70086290575800.....	395
54350.....	338	ACP3.....	12, 35, 112-113, 119, 121
54355.....	339	ACP4.....	12, 37
54360.....	339	ARC12.....	12, 44, 114-115, 119, 121
54365.....	339	ARC13.....	12, 45, 114-115, 119, 121
54370.....	340	ARC15.....	13, 46, 114-115, 119, 121
54375.....	340	ARC16SC.....	12, 43, 112-113, 119, 121
54380.....	340	Arctic LR16SC.....	13, 56, 112-113, 118
54430.....	341	Arctic LR2SN.....	13, 55, 112-113, 118, 121
54435.....	341	BOP.....	14, 76-77, 116-117, 120-121
54450.....	357	BR7.....	15, 101, 114-115, 118, 121
54455.....	357	CB101.....	422
54500.....	341	Desert DR16SC.....	13, 50, 112-113, 118, 121
54503.....	342	Desert DR1SN.....	13, 48, 112-113, 118, 121
54505.....	342	Desert DR2SN.....	13, 49, 112-113, 118, 121
54515.....	342	Desert DR5.....	13, 51, 116-118, 121
54520.....	343	Desert DUT.....	13, 52, 116-118, 121
54530.....	343	DGF1.....	387
54535.....	343	DGF2.....	387
54600.....	344	DR1SN.....	13, 48, 112-113, 118, 121
54603.....	344	DR16SC.....	13, 50, 112-113, 118, 121
54605.....	345	DR2SN.....	13, 49, 112-113, 118, 121
54610.....	345	DR5.....	13, 51, 116-118, 121
54615.....	346	DUT.....	13, 52, 116-118, 121
54650.....	346	FXG.....	15, 89, 112-113, 120-121
54655.....	346	G4826.....	15, 91, 116-117
54660.....	347	G4867.....	15, 92, 116-117
54663.....	347	G4890.....	15, 93, 116-117
54665.....	348	GC-Pliers-0001.....	361
54675.....	347	GFIT100.....	396
54700.....	348	HR4.....	15, 104, 112-113, 118, 121
54703.....	349	HR6.....	13, 53, 112-113, 118, 121
54705.....	349	HS150.....	419

Alphanumeric Index by Product Number

PRODUCT #	PAGE #	PRODUCT #	PAGE #
HS150M.....	419	SCP3.....	12, 61, 112-113, 119, 121
HS501.....	420	SFS.....	14, 75, 112-113, 118, 121
HS503.....	420	SGUN.....	14, 71, 116-117, 120-121
IG.....	15, 86, 112-113, 120-121	SHJ.....	14, 72, 116-117, 120-121
IGHT.....	15, 88, 112-113, 120-121	SR12.....	13, 65, 114-115, 119, 121
IGTC.....	15, 87, 112-113, 120-121	SR13.....	14, 66, 114-115, 119, 121
LR16SC.....	13, 56, 112-113, 118	SR14A.....	14, 74, 116-117, 119, 121
LR2SN.....	13, 55, 112-113, 118, 121	SR15.....	14, 67, 114-115, 119, 121
MIL-DTL-13444H Type I.....	14, 80, 116-117, 120-121	SR16SC.....	13, 60, 112-113, 119, 121
MIL-DTL-13444H Type III.....	14, 81, 116-117, 120-121	SR18.....	15, 102, 114-115, 120-121
MIL-DTL-13531 Type II.....	14, 82, 116-117, 120-121	SR1SN.....	13, 58, 112-113, 118, 121
MIL-DTL-39921.....	14, 83, 116-117, 120-121	SR2SN.....	13, 59, 112-113, 118, 121
MIL-DTL-8788.....	15, 84, 116-117, 120-121	SR3.....	13, 62, 112-113, 118, 121
NR7.....	15, 97, 114-115, 118, 121	SR5.....	13, 63, 116-118, 121
NR8.....	15, 98, 114-115, 119, 121	SR6.....	13, 64, 112-113, 118, 121
NSFX.....	14, 73, 116-118, 121	SR7.....	15, 95, 114-115, 118, 121
PC1000i.....	416-417	SR8.....	15, 96, 114-115, 118, 121
PC125M.....	400-401	TR7.....	15, 99, 114-115, 118, 121
PC125PS.....	404-405	TR8.....	15, 100, 114-115, 118, 121
PC125RCD.....	402-403	UCF2.....	383
PC150.....	408-409	UCF3.....	383
PC150H.....	406-407	UCF6.....	384
PC200i.....	410-411	UCF8.....	385
PC440i.....	412-413	UCF9.....	385
PC600i.....	414-415	UCF10.....	386
PCTB-1500.....	418	UCF11.....	386
PCTB-2500.....	418	XCP3.....	12, 34, 112-113, 119, 121
Prospector BOP 3000.....	14, 76, 116-117, 120-121	XCP3S.....	12, 38, 114-115, 119
Prospector BOP 5000.....	14, 77, 116-117, 120-121	XCP4.....	12, 36, 114-115, 119, 121
Prospector Hot Oiler.....	14, 78, 116-117	XCP4S.....	12, 39, 114-115, 119
S4SH.....	14, 68, 114-115, 119, 121	XCP5S.....	12, 40, 114-115, 119
S4SP.....	14, 69, 114-115, 119, 121	XCP6S.....	12, 41, 114-115, 119
		XR16SC.....	2, 12, 32, 112-113, 119, 121



Industrial Fluid Solutions

Market segment

Hydraulic Hose

Contact

Continental

703 S. Cleveland Massillon Road

Fairlawn, OH 44333-3023 U.S.A.

1-800-235-4632

www.contitech.us

Your local contact

www.contitech.de/contactlocator

Canada

1-888-275-4397

Mexico

1-800-439-7373



Continental
Hydraulics Catalog Hydraulic Hose, Fittings & Equipment